

K18  
CATALOGUE



## TABLEAU DES LÉGENDES

### CLÉS MIXTES ①

NF ISO 1711-3318-691 / DIN 899-3113.

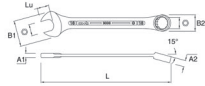

②	③	④	⑤	⑦
mm	L mm	A1 mm	A2 mm	g
4	100	3,6	4,5	15

### MARTEAU RIVOIR DE MÉCANICIEN MANCHE HICKORY

Modèle français.  
Hickory américain  
véritable.

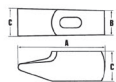

⑥	⑦
C mm	B mm
22	17

① DÉSIGNATION DU PRODUIT

② L mm : largeur du produit non emballé

③ POIDS du produit non emballé

④ SUR-CARTE : produit sur carte ou sous coque

⑤ RÉFÉRENCE complète, nécessaire au bon traitement de la commande  
Quelques références en gris sont sur commande, se renseigner sur les délais

⑥ MANCHE DE RECHANGE ET COIN DE RECHANGE

⑦ UNITÉ DE VENTE : quantité obligatoire ou multiple de celle-ci

P.520 INDEX ALPHABÉTIQUE

P.524 INDEX DES RÉFÉRENCES

P.529 CONDITIONS GÉNÉRALES DE VENTE



# SOMMAIRE

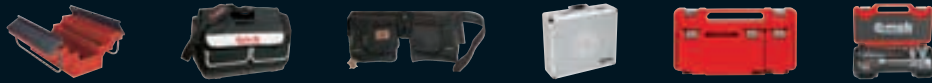

**001** Rangement  
P.016 et compositions



**002** Cliquets  
P.062 et douilles



**003** Clés à ouverture fixe  
P.096 et variable

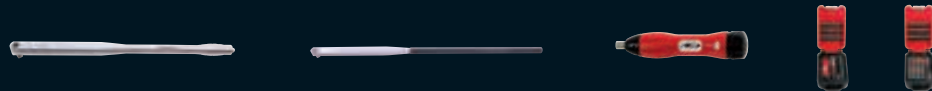

**004** Dynamométrie  
P.120



**005** Tournevis, clés mâles  
P.126 et embouts



**006** Pincés, cisailles,  
P.156 coupe-boulons



**007** Sciage, coupe,  
P.188 limes, râpes, ciseaux

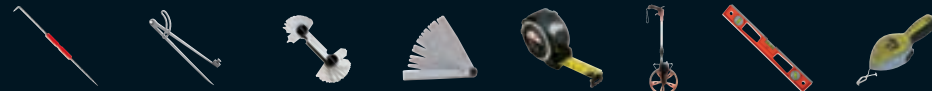

**008** Métrologie,  
P.224 mesure, traçage



**009** Découpe-joints  
P.248



**010** Marteaux  
P.254 et outils forgés



**011** Accès en hauteur,  
P.300 tréteaux



**012** Plomberie, étaux,  
P.316 maintenance, éclairage



**013** Gros  
P.340 œuvre



**014** Second  
P.390 œuvre



**015** Truelles, platoirs,  
P.462 couteaux



**016** Outils universels  
P.488 bâtiment



# LES RACINES HISTORIQUES

## MAÎTRE DE FORGE DEPUIS 1743



C'est en 1743 que la forge voit le jour puis en 1920 que la société **mob** prend sa forme moderne au Chambon-Feugerolles, près de Saint Etienne (dans la Loire, 42).

Le groupe **mob** a poursuivi une expansion fulgurante, notamment par croissance externe, y compris en Europe avec plusieurs sites de fabrication, pour rivaliser avec les plus grands fabricants d'outils à main.

La dernière étape est la fusion avec la société Mondelin, à la fois marque réputée et fabricant notoire.

1743

Création  
des Forges  
de Milour.

1920

Création  
des Forges  
de la Loire  
Moulin Blanc.

1952

Achat  
Ets Peyron.  
Fabricant  
de ciseaux  
à bois.

1956

Fusion Forge  
de la Loire et  
de Millour.

1969

Distribution  
Vallorbe.  
Limes de  
précision.

1982

Achat  
Talabot.  
Fabricant n°1  
de limes de  
mécanique.

1983

Achat  
Brunon.  
Fabricant de  
broches et  
burins.

1986

Achat  
Cassi.  
Fabricant  
de truelles.

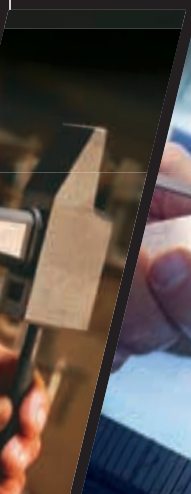
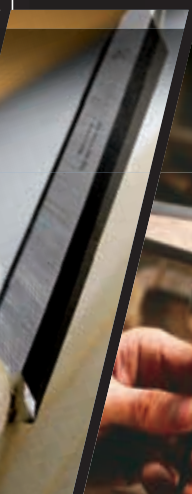



ATELIER DE FORGE



OPÉRATION DE TREMPE

## LES DATES CLÉS

1991

Achat Peddinghaus, fabricant n°1 de marteaux en Allemagne.

1995

Achat Mekanix, fabricant de découpe-joints.

1998

Achat IUS, fabricant de clés et pinces.

1999

Achat Dynachoc, fabricant de maillets.

2005

Nouvelle usine limes.

2008

Construction nouvelle usine IUS.

2012

Reprise de l'activité outillage Schröder, fabricant Allemand d'embouts de vissage.

2016

Fusion avec Mondelin.





NOUVEL ATELIER DE PEINTURE EPOXY GRANDES DIMENSIONS



1/



2/

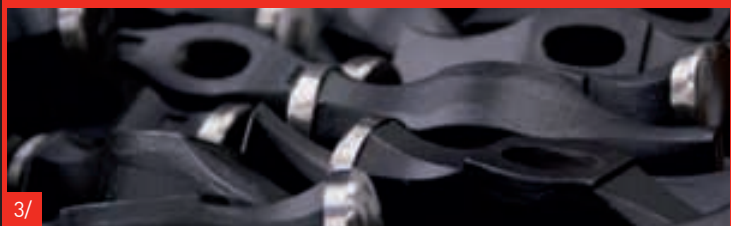

3/

1/ INJECTION DE RÉSINE POLYURÉTHANE  
2/ EMMANAGEMENT  
3/ TÊTES DE MARTEAUX À GARNIR APRÈS FINITION

## INVESTISSEMENTS RÉCENTS

**mob** a investi dans une nouvelle chaîne de peinture poudre époxy, très qualitative et écologique, pour les produits longs comme les barre à mine ou les pinces à décoffrer. MOB utilise les procédés les plus modernes comme le centre d'usinage des têtes de marteaux.

Les forgerons français exercent leur talent au **Chambon-Feugerolles**, en combinant techniques ancestrales et technologie.

La forge à chaud est physiquement exigeante, tout comme les nombreuses opérations de façonnage du métal : décalaminage, ébavurage, usinage, trempe, peinture, polissage.

Manier des morceaux d'acier exige puissance, précision et maîtrise des températures.

# UN FABRICANT FRANÇAIS ET EUROPÉEN



USINE DE SERRAGE IUS À BRASOV

## LE CHOIX DE L'EUROPE

En dehors de la France, **mob** possède plusieurs unités de production en Europe : à Schwelm, en Allemagne, suite à l'acquisition de Schröder, marque réputée en petit outillage à main Made in Germany ; à Brasov en Roumanie, site sur lequel sont réalisés les outils pour métiers techniques (clés, pinces, etc.).

La fabrication européenne permet à la fois de maîtriser la qualité et de contenir les coûts. Les filiales sur place sont également tournées vers l'export, et diffusent les produits **mob** partout dans le monde.



USINE SCHWELM EN ALLEMAGNE

# GARANTIE & QUALITÉ

LA QUALITÉ, C'EST AVANT TOUT UN  
ÉTAT D'ESPRIT, UNE VIGILANCE DE  
CHAQUE INSTANT DEVENUE  
NATURELLE, À TOUS LES NIVEAUX.



Les professionnels n'ont pas de temps à perdre avec la qualité médiocre. Pourtant, ce n'est pas une raison pour leur vendre la qualité au prix fort. Et si **mob** réinventait le rapport qualité/prix ?

La qualité produits **mob** surpasse de 30% jusqu'à 450% les exigences des normes NF EN ISO et DIN. La certification ISO 9001-2008 est le reflet de la démarche de management par la qualité.

**Les outils forgés sont garantis sans limite de durée contre les défauts de fabrication.** La garantie s'applique par simple échange ou réparation. La garantie totale, c'est l'assurance de votre sérénité.

Pourtant, le souci de l'optimisation des coûts est omniprésent : les dépenses publicitaires sont écartées au profit de la communication par bouche à oreille. Le premier média de **mob**, c'est le produit.

Le résultat : un rapport qualité/prix inégalé, pour la plus grande satisfaction des décideurs.



LA GARANTIE DE NOS OUTILS  
ET LA CERTIFICATION ISO 9001  
SIGNENT NOTRE  
ENGAGEMENT QUALITÉ.



AUTO-CONTRÔLE

STATION QUALITÉ





# INNOVATION

DANS UN MARCHÉ DOMINÉ PAR LES HABITUDES, LORSQUE L'USAGE LE JUSTIFIE, L'UTILISATEUR SE RANGE DU CÔTÉ DU DESIGNER.

FUSION BOX  
SYSTÈME BREVETÉ



MARTEAU PROTECT



CLÉS STILLSON MONO-RESSORT



TÊTE DE SÉCURITÉ

**Comment améliorer l'efficacité du geste ?  
Comment sécuriser l'utilisateur ?  
Comment lui procurer un confort maximum ?**

Autant de questions qui trouvent leurs réponses au cœur des équipes de développement. De nombreux brevets et modèles déposés sont le gage de cette volonté et du dynamisme de **mob**. Avec des siècles de mise au point par l'usage, les outils à main semblent dénués de potentiel d'innovation.

Pourtant, en permanence, il est possible d'apporter plus de sécurité, plus d'ergonomie et plus de productivité.

La démarche de **mob** consiste d'abord à observer les utilisateurs professionnels, inspireurs de progrès.



NOUVELLE  
SERVANTE PROLINER



Roger

**MONDELIN**

# NOUVEL ATELIER SERRURERIE



L'UN DES DEUX LASERS DE DÉCOUPE



Roger  
**MONDELIN**

C'est en 1952 que naît la société Roger Mondelin à Ambierle près de Roanne.

## LA MAÎTRISE DE LA TÔLE ET DU FEUILLARD

Excellente maîtrise du travail de la tôle et du feuillard avec ses nouveaux postes de découpe laser et de presse plieuse permettant la réalisation des lames de platoirs, couteaux, ERGOLAME® ainsi que tous les composants des produits fabriqués à Ambierle et nécessitant du pliage.





DÉCOUPE LASER PLATINES LUPANO



DRESSAGE DES DENTS DE TALOCHES-GRATTONS



PLIAGE : TRUELLE D'ANGLE, ERGOLAME®...



RÈGLE À NIVEAUX

## LA MAÎTRISE DU TUBE

Une ligne complète automatisée de façonnage des tubes et profilés intègre la découpe laser, le dégraisage et le cintrage. Cet flôt permet de réaliser des sous-ensembles aussi bien en acier, inox, qu'en aluminium. Très récemment, l'usine a investi dans un centre d'usinage pour profil aluminium qui permet de fabriquer par exemple des règles à niveaux.



MONTAGE UNITAIRE DES LEVPANO

## LA MÉCANO-SOUDURE

Une structure mécanosoudée est un assemblage de pièces métalliques en acier ou en aluminium obtenu par soudage, et ayant une fonction mécanique.

**LA PREMIÈRE OPÉRATION** est la découpe laser des tubes acier et aluminium. Par exemple, la découpe des structures des **LEVPANO®**, tréteaux, pose-bordures, chariots...

**LA DEUXIÈME OPÉRATION** sensible est la mécano-soudure. **MONDELIN** a choisi de s'équiper en robots de soudure pour offrir toutes les garanties de qualité et de robustesse aux produits tels que les pose-bordures, les tréteaux, les **LEVPANO®** et **LESCABO®**, qui sont autant de produits phares de la gamme **MONDELIN**.

Les robots apportent en effet répétabilité et précision aux assemblages. L'homme apporte ensuite toute sa valeur ajoutée dans les opérations de vérification et de montage. Ainsi chaque **LEVPANO®** est monté et testé unitairement.

L'opération de mise en peinture est également importante. **MONDELIN** réalise cette opération dans ses locaux et a choisi la peinture époxy pour ses qualités distinctives de résistance et de durabilité.



MISE EN PEINTURE EPOXY

## LE BOIS : UN MÉTIER EN SOI

Le bois est un matériau bien à part. Ce n'est pas une matière dont on prévoit à l'avance le rendement. Tout l'art des menuisiers est d'écarter les nœuds et fils de travers pour ne garder que le bois qui fera un manche ou une taloche parfaite.

Matériau à la fois léger et naturellement anti-vibration, il regagne aujourd'hui ses lettres de noblesse par sa dimension environnementale.

La menuiserie d'Ambierle est complète et intégrée : le bois arrive en grumes ou formats. Une fois délignés et débités, les plateaux bois sont usinés pour obtenir des poignées, des taloches, des poutres de tréteaux, des plateformes **LESCABO®** ou **LEVPANO®**...

Un système de ventilation centralisée permet d'aspirer chutes et copeaux. Ces déchets sont ensuite valorisés en combustibles de chauffage dans notre chaudière BIOMASSE.



DÉLIGNAGE

# LA MAÎTRISE DE LA MÉCANO-SOUDURE ET DU BOIS



Roger

MONDELIN



ATELIER BOIS



SOUDURES MARCHES ESCABEAUX



Roger

**MONDELIN**

# NOUVEL ATELIER

# INJECTION PLASTIQUE



PRESSE D'INJECTION PLASTIQUE

## LES PRESSES À INJECTER

L'atelier a été intégralement repensé en 2017-2018 pour intégrer de nouvelles presses à injecter pour les manches d'outils notamment. Le parc de presses permet la production de pièces de petite taille (ex : composants LESCABO®, LEVPANO®), de taille moyenne (ex : rabot-râpes, manches de couteaux et platoirs, manches de marteaux), et de taille plus importantes (ex : seaux, auges, ta-loches, PROJJOINT®).



INJECTION DE SEAUX DE MAÇON

## LES MOULES

L'injection plastique permet de réaliser des produits par moulage. Intégré à l'unité plasturgie un atelier conçoit et entretient les moules. Ceux-ci sont maintenant réalisés par usinage dans l'autre usine française du groupe, au Chambon-Feugerolles (42).



INJECTION DES TALOCHES ABS



INJECTION MANCHE CARBON QUADRI-MATIÈRE

## CONTRÔLE DE LA **MATIÈRE**

L'injection est réalisée à partir de granulés de matières plastiques. Le choix de matières de haute qualité et surtout adaptées à la technicité du produit est capitale pour obtenir un produit de qualité. L'usine d'Ambierle (42) injecte ainsi une large variété de plastiques (Polystyrène, PS choc, ABS, polyuréthane, polyéthylène, polypropylène, élastomère, thermoplastique caoutchouté...)



## MAÎTRISE DES TECHNIQUES D'**INJECTION**

L'usine d'Ambierle (42) maîtrise l'injection bi et tri-matière. Ce procédé permet d'optimiser les performances de chaque matière pour créer des manches composites extrêmement performants. La technologie d'injection assistée par gaz (IAG) est un procédé technique au cours duquel l'âme plastique d'une pièce moulée volumineuse est repoussée à l'aide d'azote de sorte qu'un canal en forme de tube se forme. L'usine d'Ambierle (42) maîtrise également parfaitement ce procédé récent.



# LE SERVICE CLIENT



## UNE LOGISTIQUE RIGoureuse

La réactivité est un challenge permanent. La proximité est l'une des clés de la réussite sur nos marchés. La productivité de préparation des commandes en est une autre.

Le site logistique du Chambon-Feugerolles situé en France est entièrement dédié à la préparation des commandes des produits **MOB** et **MONDELIN**.

Les automates de stockage (5 Tours MODULA SYSTEM de 13 m de haut) totalement reliés au système d'information du groupe, permettent de condenser les articles et d'en faciliter le picking, augmentant de façon considérable la productivité de préparation des commandes.

## UN SERVICE COMMERCIAL À VOTRE ÉCOUTE

Nos équipes à dimension humaine sont notre force. Nos chargés de clientèle répondent à vos interrogations sur vos commandes (lancement de produits, suivi des délais de production, suivi des stocks, des expéditions...).

Nos commerciaux vous accompagnent sur le terrain, notamment pour vos choix produits, vos implantations.

### LES TOURS EN CHIFFRES

- 13 mètres de haut.
- 100 plateaux pouvant supporter 750 kg chacun, soit 75 tonnes par tour.

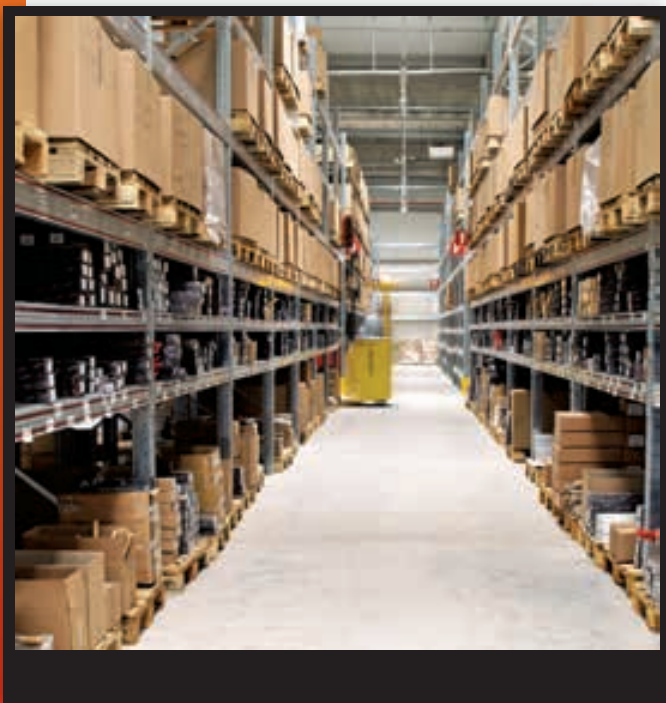



# LA BASE DE DONNÉES



À l'ère du digital, venez découvrir notre site internet [www.mob-mondelin.fr](http://www.mob-mondelin.fr) et retrouvez nos actus, nos nouveautés ou encore nos vidéos. Notre site est responsive, c'est-à-dire que vous pouvez le consulter aussi bien sur ordinateur que sur tablette ou smartphone.

Les ventes via internet deviennent un enjeu d'avenir pour nos distributeurs.

Aussi, en tant que fabricants, notre devoir est de mettre à disposition toutes les données nécessaires pour accompagner nos clients dans cette mutation. Nous avons ainsi structuré et enrichi nos données au sein d'une base de données P.I.M. (informations produits), et créé des liens url de nos photos, vidéos et toutes nos fiches produits. Nous sommes ainsi en mesure d'exporter et communiquer ces données à nos clients.





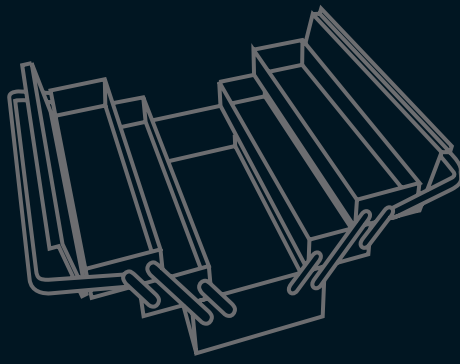

# 001

## RANGEMENT ET COMPOSITIONS

**P.19**

| SERVANTES



**P.31**

| SERVANTES GARNIES



**P.41**

| PORTE-OUTILS



**P.25**

| MODULES DE  
RANGEMENT



**P.34**

| BOÎTES  
À OUTILS



**P.43**

| VALISES ET  
MALLETES



**P.27**

| MODULES DE  
RANGEMENT MOUSSE



**P.37**

| BOÎTES À OUTILS  
TEXTILE



**P.44**

| FUSION BOX



**P.30**

| ACCESSOIRES



**P.54**

| CONTENANTS  
GARNIS



# SERVANTE XLINER

XLINER

## ROBUSTESSE ET DESIGN

**Une gamme de servantes  
qui allie robustesse  
et design**

- Plateau en acier inoxydable
- Construction robuste
- Charge statique : 1 000kg
- Tiroirs : charge 40kg
- Marquage de l'arrière  
avec une technologie innovante :  
le Water-transfert

**Une gamme de servantes  
déclinée en plusieurs versions :**

- 4 ou 5 modules
- avec ou sans système anti-basculement

**Des servantes plus maniables  
Une poignée étudiée et dessinée  
par notre bureau d'étude pour  
une bonne ergonomie :**

- en poussée à 2 mains
- en traction à 1 main





## SERVANTE XLINER, 4 MODULES

### PLATEAU INOX

- Ultra-résistant en acier inoxydable texturé et bords en plastique bi-matière.
- Charge statique de 1000 kg
- Poignée bi-matière intégrée à la construction du plateau
- Espace de rangement : le plateau est équipé de 2 vide-poches pour la visserie et de 8 emplacements pour tournevis

### NOUVELLES ROUES

- Nouvelles roues en polyuréthane, plus souples pour une meilleure mobilité Ø 125mm :
- Moins d'effort au démarrage
- Plus facile à déplacer même sur les sols accidentés

### SÉCURITÉ

- Version anti-basculement disponible : 1 seul tiroir ouvert en même temps
- Fermeture centralisée et simultanée de tous les tiroirs par clés

**XLINER**



### SERVANTE XLINER 4 MODULES, 6 TIROIRS

Plateau inox. Marquage water-transfert au dos. Chaque tiroir peut contenir 4 modules simples.

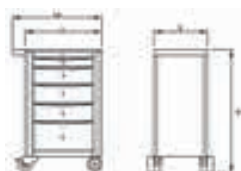

La mm	L mm	E mm	H mm	kg	Ref.	☐
885	805	465	975	81	9519000601	1

H mm Tiroir	H mm Tiroir	H mm Tiroir	H mm Tiroir	H mm Tiroir	H mm Tiroir	Lxl mm Tiroirs
60	60	60	60	100	240	670x398

### SERVANTE XLINER 4 MODULES, 6 TIROIRS, ANTI-BASCULEMENT

Système anti basculement. Plateau inox. Marquage water-transfert au dos. Chaque tiroir peut contenir 4 modules simples.



La mm	L mm	E mm	H mm	kg	Ref.	☐
885	805	465	975	81	9517000601	1

H mm Tiroir	H mm Tiroir	H mm Tiroir	H mm Tiroir	H mm Tiroir	H mm Tiroir	Lxl mm Tiroirs
60	60	60	60	100	240	670x398

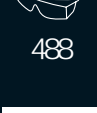



# SERVANTES



## SERVANTE XLINER 5 MODULES

### SERVANTE GRAND VOLUME

- Plan de travail extra-large de plus d'1 m en inox et bimatière
- 6 roues

### PLATEAU INOX

- Ultra-résistant en acier inoxydable texturé et bords en plastique bi-matière.
- Charge statique de 1000 kg
- Poignée bi-matière intégrée à la construction du plateau
- 2 vide-poches pour la visserie et de 8 emplacements pour tournevis.

### SÉCURITÉ

- Version anti-basculement :
- 1 seul tiroir ouvert en même temps
- Fermeture centralisée et simultanée de tous les tiroirs par clés

### ROUES MANIABLES

- Roues en polyuréthane, plus souples pour une meilleure mobilité Ø 125 mm :
- Moins d'effort au démarrage
- Plus facile à déplacer même sur les sols accidentés
- 6 roues pour encore plus de maniabilité (2 roues fixes + 4 roues orientables)
- Pivote à 360°
- Facile à manipuler et à positionner près d'un mur ou entre plusieurs obstacles

**XLINER**



### SERVANTE XLINER 5 MODULES, 7 TIROIRS, ANTI-BASQUEMENT

Système anti basculement. Plateau inox. Marquage water-transfert au dos. Chaque tiroir peut contenir 5 modules simples.



**XLINER**



La mm	L mm	E mm	H mm	kg	Ref.	📦	
1065	980	465	970	97	9518000701	1	
H mm Tiroir	H mm Tiroir	H mm Tiroir	H mm Tiroir	H mm Tiroir	H mm Tiroir	H mm Tiroir	Lxl mm Tiroirs
60	60	60	60	60	120	140	830x398



## SERVANTE XLINER AVEC ARMOIRE

### SERVANTE GRAND VOLUME

- Armoire avec porte latérale, équipée de 2 tablettes intérieures modulables en hauteur. La fermeture de la porte se fait par une clé séparée.
- Plan de travail extra-large de plus d'1 m en inox et bimatière
- 6 roues
- 6 tiroirs + armoire.

### PLATEAU INOX

- Charge statique de 1000 kg
- Ultra-résistant en acier inoxydable texturé et bords en plastique bi-matière.
- Poignée bi-matière intégrée à la construction du plateau
- Espace de rangement : le plateau est équipé de 2 vide-poches pour la visserie et de 8 emplacements pour tournevis.

### FINITION

- Côtés perforés pour accueillir des accessoires : poubelle, porte-flacons, porte-rouleau
- Bumpers latéraux plus souples
- Peinture époxy
- Dos avec technologie innovante : le WATER TRANSFERT



**XLINER**



### SERVANTE XLINER AVEC ARMOIRE ET 6 TIROIRS

Armoire latérale. Plateau inox. Marquage water-transfert au dos. Chaque tiroir peut contenir 3 modules simples.



**XLINER**



La mm	L mm	E mm	H mm	kg	Ref.	☐
1065	980	465	970	85	9522000601	1

H mm Tiroir	H mm Tiroir	H mm Tiroir	H mm Tiroir	H mm Tiroir	H mm Tiroir	Lxl mm Tiroirs
60	60	60	60	100	240	670x398

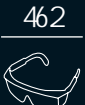



# SERVANTES



## SERVANTE PROLINER

### RÉSISTANCE

- Construction résistante à 850 kg de charge statique.
- Tiroirs résistants à 25 kg.

### SÉCURITÉ

- Verrouillage des tiroirs pour éviter toute ouverture intempesive lors des déplacements - déverrouillage par simple action de la poignée.
- Condamnation centralisée des tiroirs - 2 clés.

### MOBILITÉ

- 2 roues orientables dont 1 à frein et 2 roues fixes.

### PLATEAU

- Injecté en polypropylène, avec rebords anti-chute.
- Poignée bimatière intégrée au plateau
- Prévu pour recevoir un étau de 100 mm avec base tournante
- Emplacements tournevis
- Alvéoles pour visserie

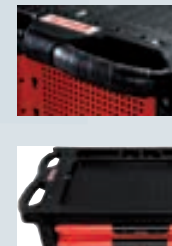

### SERVANTE PROLINER 3 MODULES, 5 TIROIRS



Déverrouillage par poignée basculante. Plateau injecté. Chaque tiroir peut contenir 3 modules simples + 1 module de calage.



La mm	L mm	E mm	H mm	kg	Ref.	📦
770	690	465	970	65	9516000501	1

H mm Tiroir	H mm Tiroir	H mm Tiroir	H mm Tiroir	H mm Tiroir	Lxl mm Tiroirs
60	60	100	140	240	546x398

### SERVANTE PROLINER 3 MODULES, 7 TIROIRS



Déverrouillage par poignée basculante. Plateau injecté. Chaque tiroir peut contenir 3 modules simples + 1 module de calage.



La mm	L mm	E mm	H mm	kg	Ref.	📦
770	690	465	970	61	9516000701	1

H mm Tiroir	H mm Tiroir	H mm Tiroir	H mm Tiroir	H mm Tiroir	H mm Tiroir	H mm Tiroir	H mm Tiroir	Lxl mm Tiroirs
60	60	60	60	60	120	140	546x398	

### SERVANTE PROLINER 3 MODULES, 6 TIROIRS



Déverrouillage par poignée basculante. Plateau injecté. Chaque tiroir peut contenir 3 modules simples + 1 module de calage.



La mm	L mm	E mm	H mm	kg	Ref.	📦
770	690	465	970	66	9516000601	1

H mm Tiroir	H mm Tiroir	H mm Tiroir	H mm Tiroir	H mm Tiroir	H mm Tiroir	Lxl mm Tiroirs
60	60	60	60	100	240	546x398

### SERVANTE PROLINER 7 TIROIRS ETAU ET ACCESSOIRES



Avec étau de 100 mm sur base tournante, 1 poubelle, 1 porte-flacon, 1 porte-document. Déverrouillage par poignée basculante. Plateau injecté. Chaque tiroir peut contenir 3 modules simples + 1 module de calage.



La mm	L mm	E mm	H mm	kg	Ref.	📦
770	690	465	970	72	9516001701	1

H mm Tiroir	H mm Tiroir	H mm Tiroir	H mm Tiroir	H mm Tiroir	H mm Tiroir	H mm Tiroir	H mm Tiroir	Lxl mm Tiroirs
60	60	60	60	60	120	140	546x398	





## SERVANTE BASELINER

### ➤ RÉSISTANCE

Construction résistante à 850 kg de charge statique.  
Tiroirs résistants à 25 kg.

### ➤ SÉCURITÉ

- Condamnation centralisée des tiroirs - 2 clés.

### ➤ MOBILITÉ

- 2 roues orientables dont 1 à frein et 2 roues fixes.

### ➤ FINITION

- Plateau métal
- Peinture époxy
- Poignée acier
- Côtés perforés pour accueillir des accessoires
- Poignées de tiroir en aluminium brossé, équipées de porte-étiquette plastique
- Livrée avec un jeu de stickers (pictos, couleurs, initiales et chiffres)
- Tapis de fond dans chaque tiroir
- Chaque tiroir peut contenir 3 modules simples (ajouter le jeu de calage adapté)

**BASELINER**



### SERVANTE BASELINER 3 MODULES, 6 TIROIRS

Plateau métal.  
Chaque tiroir peut contenir 3 modules simples + 1 module de calage.



**BASELINER**

La mm	L mm	E mm	H mm	kg	Ref.	📦
770	690	465	970	56	9515000601	1

H mm Tiroir	H mm Tiroir	H mm Tiroir	H mm Tiroir	H mm Tiroir	H mm Tiroir	Lxl mm Tiroirs
60	60	60	60	100	240	546x398



16



62



96



120



126



156



188



224



248



254



300



316



340



390



462



488

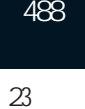

23



# SERVANTES



## SERVANTE CLASSIC

### ■ SIMPLE ET ROBUSTE

Construction résistante à 850 kg de charge statique.  
Tiroirs résistants à 25 kg.

### ■ SÉCURITÉ

- Condamnation centralisée des tiroirs par clés.

### ■ MOBILITÉ

- 2 roues orientables dont 1 à frein et 2 roues fixes (roues livrées non montées)

### ■ FINITION

- Plateau métal + mousse
- Peinture époxy
- Poignée acier (livrée non montée)
- Tapis de fond dans chaque tiroir
- Chaque tiroir peut contenir 3 modules simples (ajouter le jeu de calage adapté)



### ■ SERVANTE CLASSIC 3 MODULES, 6 TIROIRS

Plateau métal.  
Chaque tiroir peut contenir 3 modules simples + 1 module de calage.

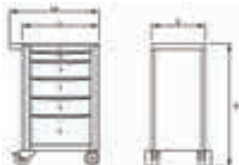

La mm	L mm	E mm	H mm	kg	Ref.	📦
766	677	460	993	47,5	9523000601	1
H mm Tiroir	H mm Tiroir	H mm Tiroir	H mm Tiroir	H mm Tiroir	H mm Tiroir	Lxl mm Tiroirs
60	60	60	60	140	215	546x398



## MODULES THERMO-FORMÉS

### MODULE DE 12 CLÉS MIXTES

8 à 22 mm.

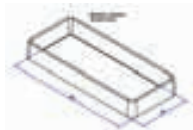

Contenu	▲ g	Ref.	☐
8-9-10-11-12-13-14-16-17-18-19-22 mm	1300	9547012001	1
Vide	150	9547000001	1

### MODULE DE 16 CLÉS MIXTES

6 à 24 mm.



Contenu	▲ g	Ref.	☐
6-7-8-9-10-11-12-13-14-15-16-17-18-19-22-24 mm	1470	9547016001	1
Vide	145	9547000001	1

### MODULE DE 5 CLÉS MIXTES

22 à 32 mm.



Contenu	▲ g	Ref.	☐
22-24-27-30-32 mm	2350	9544005001	1
Vide	130	9544000001	1

### MODULE DE 12 CLÉS MIXTES À CLIQUET

8 à 19 mm.



Contenu	▲ g	Ref.	☐
8-9-10-11-12-13-14-15-16-17-18-19 mm	1625	9548012001	1
Vide	145	9564000001	1

### MODULE DE 9 CLÉS A FOURCHES

6 à 24 mm.



Contenu	▲ g	Ref.	☐
6x7-8x9-10x11-12x13-14x15-16x18-17x19-20x22-22x24 mm	1220	9545009001	1
Vide	140	9545000001	1

### MODULE DE 10 CLÉS À PIPE

8 à 19 mm.



Contenu	▲ g	Ref.	☐
6x6 : 8-10-11-12-13-14-16-17-18-19 mm	2350	9565010001	1
6x12 : 8-10-11-12-13-14-16-17-18-19 mm	2300	9565010101	1
Vide	130	9565000001	1

### MODULE DE 4 CLÉS 4X4

8 à 24 mm.



Contenu	▲ g	Ref.	☐
8-10-12-13 + 9-11-14-15 + 16-17-18-19 + 20-21-22-24 mm	900	9566004001	1
Vide	130	9566000001	1

### MODULE DOUILLES ET CLIQUETS 1/4" 38 PIÈCES

- 10 douilles de 5.5 à 14 mm
- 1 cliquet
- 2 rallonges : 50 mm + 125 mm
- 1 poignée coulissante - 1 cardan
- 9 clés mâles
- 13 douilles tournevis + 1 poignée emmanchée



Contenu	▲ g	Ref.	☐
Ref. 9210 : 5.5-6-7-8-9-10-11-12-13-14 mm / Ref. 9200 / Ref. 9270 / Ref. 9250 / Ref. 9260 : 50-125 mm / Ref. 9283 / Ref. 929 : PH1-PH2-H4-H5-H6-PZ1-PZ2-0.6x4-1x5.5-T10-T15-T20-T25 / Ref. 9062	1135	9541038001	1
Vide	145	9541000001	1

### MODULE DOUILLES ET CLIQUETS 1/4" 61 PIÈCES

- 13 douilles de 3,2 à 14 mm
- 1 cliquet
- 2 rallonges : 50 mm + 125 mm
- 1 poignée coulissante
- 1 cardan
- 30 embouts
- 1 porte-embout
- 1 douille porte-embout
- 1 douille tournevis
- 1 poignée emmanchée
- 9 clés mâles



Contenu	▲ g	Ref.	☐
Ref. 9210 : 3,2-4-5-5.5-6-7-8-9-10-11-12-13-14 mm / Ref. 9200 / ef. 9270 / Ref. 9250 / Ref. 9260 : 50 mm + 125 mm / Ref. 9283 / Ref. 9460 / Ref. 919Z / Ref. 929 A / Ref. 9062	1200	9561061001	1
Vide	130	9561000001	1

### MODULE DE DOUILLES ET CLIQUETS 1/2" 23 PIÈCES

- 17 douilles de 10 à 32 mm
- 1 cliquet
- 2 rallonges : 125 mm + 250 mm
- 1 poignée coulissante
- 1 cardan
- 1 adaptateur



Contenu	▲ g	Ref.	☐
Ref. 9212 : 10-11-12-13-14-15-16-17-18-19-20-21-22-24-27-30-32 mm / Ref. 9272 / Ref. 9202 / Ref. 9252 / Ref. 9262 : 125 mm + 250 mm / Ref. 9292	3125	9562023001	1
Vide	130	9562000001	1

### MODULE DE DOUILLES ET CLIQUETS 1/2" 24 PIÈCES

- 18 douilles : 8 à 32 mm
- 1 douille à bougie : 21 mm
- 1 cliquet
- 2 rallonges : 125 mm + 250 mm
- 1 poignée coulissante
- 1 cardan



Contenu	▲ g	Ref.	☐
Ref. 9212 : 8-9-10-11-12-13-14-15-16-17-18-19-21-22-24-27-30-32 mm / Ref. 9272 / Ref. 9202 / Ref. 9252 / Ref. 9281 : 21 mm / Ref. 9262 : 125 mm + 250 mm	3290	9542024001	1
Vide	130	9542000001	1



16



62



96



120



126



156



188



224



248



254



300



316



340



390



462



488



# MODULES DE RANGEMENT

## MODULE DOUBLE DOUILLES ET CLIQUETS MIXTE 1/4" ET 1/2" 52 PIÈCES

Prend la place de 2 modules simples 1/4" : 12 douilles de 4 à 13 mm // 1 cliquet // 1 poignée // 1 cardan // 2 rallonges : 50-125 mm // 1 poignée tournevis // 1 douille porte-embout // 10 embouts 1/2" : 16 douilles de 10 à 32 mm // 1 cliquet // 1 poignée // 1 cardan // 2 rallonges : 125-250 mm // 2 douilles bougies : 16-21 mm.



Contenu	g	Ref.	
1/4" : Ref. 9200 / Ref. 9250 / Ref. 9260 : 50-125 mm / Ref. 9270 / Ref. 9283 / Ref. 9210 : 4-4,5-5-5,5-6-7-8-9-10-11-12-13 mm / Ref. 919 x10 (2 fentes+2 PZ+2 Torx+ 4 Hexa)	3985	9543052001	1
1/2" : Ref. 9202 / Ref. 9252 / Ref. 9262 : 125-250 mm / Ref. 9272 / Ref. 9282 : 16-21 mm / Ref. 9215 : 10-11-12-13-14-15-16-17-19-21-22-23-24-27-30-32 mm / Ref. 929A	270	9543000001	1
<b>Vide</b>			

## MODULES DE 7 TOURNEVIS



Contenu	g	Ref.	
3,5x100-4x100 5,5x125-6,5x150 - 8x150 - PH1 PH2	705	9549007001	1
3,5x100-4x100 5,5x125-6,5x150 - 8x150 - PZ1 PZ2	705	9549007101	1
2,5x75-3,5x100-4x100-4x150-5,5x150-5,5x125-6,5x150	570	9549007401	1
PH0-PH1-PH2 - PZ0-PZ1-PZ2 - 8x150	665	9549007501	1
T8-T10-T15-T20-T25-T30-T40	660	9549007201	1
<b>Vide</b>	135	9549000001	1

## MODULE DE 7 TOURNEVIS ISOLES 1000V



1000 V AC



Contenu	g	Ref.	
3,5x75-4x100-5,5x125-6,5x150 - PH1 - PZ1-PZ2	645	9549007301	1

## MODULE DE 4 PINCES CIRCLIPS

1 intérieur droit 19-60 // 1 intérieur 90° 19-60 // 1 extérieur droit 19-60 // 1 extérieur 90° 19-60.



Contenu	g	Ref.	
19-60 mm	915	9551004201	1
<b>Vide</b>	145	9551000001	1

## MODULE DE 7 TOURNEVIS DE PRECISION ET ISOLES



Contenu	g	Ref.	
2-2,5-3-PH1-PH2-4x100 VDE-testeur	315	9549007601	1

## MODULES DE 4 PINCES

1 pince universelle 180 mm // 1 pince coupante diagonale 180 mm // 1 pince becs plats 170 mm // 1 pince becs demi-ronds 170 mm.



	Contenu	g	Ref.	
<b>PVC</b>	9304-9305-9300-9301	995	9551004001	1
<b>Bimatière</b>	9304-9305-9300-9301	995	9551004101	1
<b>Vide</b>		145	9551000001	1

## MODULE DE 4 PINCES ISOLES 1000V

1 pince universelle 180 mm // 1 pince coupante diagonale 180 mm // 1 pince à becs demi-ronds 200 mm // 1 pince à dénuder 160 mm OU 1 pince à becs plats 160 mm



1000 V AC



Contenu	g	Ref.	
Ref. 9304-9305-9301-9300	995	9551004301	1
Ref. 9304-9305-9301-9303	1130	9551004401	1

## MODULE PINCE MULTIPRISE - CLÉ À MOLETTE COUPLE

Clé à molette couple 250 mm // Pince multiprise 240 mm.



Contenu	g	Ref.	
Ref. 9045 + 6480	925	9550002001	1
<b>Vide</b>	140	9550000001	1

## MODULE PINCE MULTIPRISE 240 - CLÉ À MOLETTE 200

Clé à molette 250 mm // Pince multiprise 240 mm.



Contenu	g	Ref.	
Ref. 9044- 6480	730	9550002301	1

## MODULE 2 PINCES

Pince étaux becs longs // Pince multiprise becs effilés bimatière 240 mm.



Contenu	g	Ref.	
Ref. 9306 + 6482	1300	9550002201	1
<b>Vide</b>	140	9550000001	1

## MODULE PINCE À SERTIR BOITE COSSES - COUPE-TOUT



Contenu	g	Ref.	
Ref. 9330- 0361- 9603	620	9550003001	1



## MODULE PINCE COUPANTE + UNIVERSELLE

Pince diagonale de 160mm // universelle de 180mm



Contenu	g	Ref.	☐
Ref. 9305-9304	645	9550002401	1

## MODULE 9 OUTILS DE FRAPPE

1 rivoir de 32 hickory // 1 maillet à embouts plastique de 32 // 1 burin de mécanicien 200 // 1 pointeau corps moleté // 3 chasse goupilles de 4, 5 et 6 // 1 réglét inox de 20 cm // 1 tracette



Contenu	g	Ref.	☐
Ref.0001+0369+7240+7253+7260+6285+7257	1755	9552009001	1
Vide	145	9552000001	1

## MODULE DE 5 LIMES

200 mm batarde : 1 plate à main // 200 mm mi-doux : 1 mi-ronde - 1 carrée - 1 triangulaire - 1 ronde



Contenu	g	Ref.	☐
Ref.0900+0910+0913+0914+0912	1070	9553005001	1
Vide	140	9553000001	1

## MODULE DOUBLE 18 OUTILS DE COUPE

Prend la place de 2 modules - 1 scie métaux METALCUT // 5 lames de scies HSS000 // 1 cutter 18 mm // 10 lames de rechange cutter // 1 mesure 3 m



Contenu	g	Ref.	☐
Ref. 6309+6312+6247+6270+6248	1500	9558018001	1
Vide	160	9558000001	1

## MODULE VIDE POCHE



g	Ref.	☐
145	9540000001	1

## MODULE DE CALAGE THERMOFORMÉ POUR BASELINER ET PROLINER

1 module de calage par tiroir.



Dimensions mm	g	Ref.	☐
380x55x50	50	9554000201	1



## MODULES MOUSSE

### RÉSISTANT

Mousse bi-couleur haute densité, ne casse pas, ne retient pas l'humidité et résiste aux produits de l'atelier.

### POSTE DE TRAVAIL ORDONNÉ

Chaque outil a une place propre. Inventaire des outils manquants en quelques secondes.

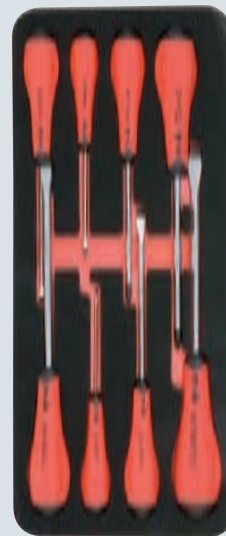

Dim L 385 x l 165 x H 30 mm

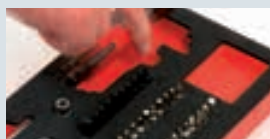

## MODULE MOUSSE 12 CLÉS MIXTES



Contenu	g	Ref.	☐
6-7-8-9-10-11-13-14 -17-18-19-21 mm	1135	9819012001	1
8-9-10-11-13-14-17-18-19-21-22-24 mm	1660	9819012101	1
Vide	80	9819000001	1

## MODULE MOUSSE 17 CLÉS MIXTES

6 à 24 mm.



Contenu	g	Ref.	☐
6-7-8-9-10-11-12-13-14-15-16-17-18-19-21-22-24 mm	1960	9800017001	1
Vide	60	9800000001	1

## MODULE MOUSSE 5 CLÉS MIXTES

27 à 32 mm.



Contenu	g	Ref.	☐
27-28-29-30-32 mm	2650	9801005001	1
Vide	60	9801000001	1



16



62



96



120



126



156



188



224



248



254



300



316



340



390



462



488



# MODULES DE RANGEMENT

## MODULE MOUSSE 10 CLÉS MIXTES À CLIQUET

8 à 19 mm.



Contenu	▲ g	Ref.	☐
8-10-11-12-13-14-16-17-18-19 mm	1330	9811010001	1
Vide	60	9811000001	1

## MODULE MOUSSE 13 CLÉS À PIPE 6X6

7 à 19 mm.



Contenu	▲ g	Ref.	☐
7-8-9-10-11-12-13-14-15-16-17-18-19 mm	2560	9802013001	1
Vide	60	9802000001	1

## MODULE MOUSSE DOUILLES 1/4" 59 PIÈCES

13 douilles 6 pans : 3,2-4-5-5,5-6-7-8-9-10-11-12-13-14 mm / 1 poignée coulissante 115 mm / 1 cliquet / 1 cardan / 2 rallonges 50 et 125 / 1 étui de 9 clés mâles / 30 embouts de vissage sur rack / 1 poignée emmanchée / 1 douille porte embouts.



Contenu	▲ g	Ref.	☐
59 pcs	1080	9803059001	1
Vide	60	9803000001	1

## MODULE MOUSSE DOUILLES 1/2" 23 PIÈCES

18 douilles 6 pans : 8-9-10-11-12-13-14-15-16-17-18-19-21-22-24-27-30-32 mm / 1 poignée coulissante 255 mm / 1 cliquet / 1 cardan / 2 rallonges 125 et 250 mm.



Contenu	▲ g	Ref.	☐
23 pcs	3065	9804023001	1
Vide	60	9804000001	1

## MODULE MOUSSE 3 ELEC+3 MECA+2 PH

Électriciens 2.5x75 - 3.5x100 - 4x100 // mécaniciens 5.5x125 - 6.5x150 - 8x150 avec écrou // PH1 - PH2.



Contenu	▲ g	Ref.	☐
8 pcs	610	9805008001	1
Vide	60	9805000001	1

## MODULE MOUSSE 3 ELEC+3 MECA+2 PZ

Électriciens 2.5x75 - 3.5x100 - 4x100 // mécaniciens 5.5x125 - 6.5x150 - 8x150 avec écrou // PZ1 - PZ2.



Contenu	▲ g	Ref.	☐
8 pcs	615	9805008101	1
Vide	60	9805000001	1

## MODULE MOUSSE 7 TOURNEVIS TORX

T10 à T40.



Contenu	▲ g	Ref.	☐
T10 - T15 - T20 - T25 - T27 - T30 - T40	635	9806007101	1
Vide	60	9806000001	1

## MODULE MOUSSE 7 TOURNEVIS TAMPER TORX

TT10 à TT40.



Contenu	▲ g	Ref.	☐
TT10 - TT15 - TT20 - TT25 - TT27 - TT30 - TT40	620	9806007001	1
Vide	60	9806000001	1

## MODULE MOUSSE 7 CLÉS MÂLES EN T HEXAGONALES

Sphériques de 4 à 10 mm - non sphériques jusqu'à 3 mm - Acier Chrome Vanadium - Tige forgée 1 pièce, sans soudure.



Contenu	▲ g	Ref.	☐
2,5-3-4-5-6-8-10 mm	1580	9820007001	1

## MODULE MOUSSE 7 CLÉS MÂLES EN T TORX

T9/T10/T15/T20/T25/T30/T40 - Acier Chrome Vanadium - Tige forgée 1 pièce, sans soudure.

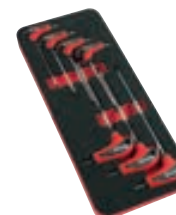

Contenu	▲ g	Ref.	☐
T9/T10/T15/T20/T25/T30/T40	1580	9821007001	1



## MODULE MOUSSE DE 8 CLÉS EMMANCHÉES EN T

Prend la place de 2 modules.  
Clés douillées en T  
6/7/8/10/11/12/13/14 mm.



Contenu	▲ g	Ref.	☐
6-7-8-10-11-12-13-14	1680	9822008001	1

## MODULE MOUSSE PINCE ÉTAU + MULTIPRISE

1 pince étaux becs longs //  
1 pince multiprise becs effilés  
240 mm manche bimatière.



Contenu	▲ g	Ref.	☐
Ref. 9306- 6482	1145	9807002001	1
Vide	60	9807000001	1

## MODULE MOUSSE 3 PINCES

1 universelle 180 mm //  
1 coupante diagonale 160 mm //  
1 becs demi-ronds 200 mm.



Contenu	▲ g	Ref.	☐
Ref. 9304- 9301- 9305	755	9808003001	1
Vide	60	9808000001	1

## MODULE MOUSSE 4 PINCES CIRCLIPS

1 intérieur droit 19-60 //  
1 intérieur 90° 19-60 //  
1 extérieur droit 19-60 //  
1 extérieur 90° 19-60.



Contenu	▲ g	Ref.	☐
19-60	680	9809004001	1
Vide	60	9809000001	1

## MODULE MOUSSE COUPE 25 OUTILS

Prend la place de 3 modules.  
1 scie métaux METALCUT / 5 lames de scies HSS000 / 1 cutter 18mm / 10 lames de rechange cutter / 1 mesure 3 m / 1 tracette carbure avec clip / 1 réglét inox 200mm / 1 lime plate à main 200mm bâtarde / 1 lime mironde 200mm mi-doux / 1 lime triangulaire 200mm mi-doux / 1 lime carrée 200mm mi-doux / 1 lime ronde 200mm mi-doux.



Contenu	▲ g	Ref.	☐
25 pcs	2460	9810025001	1
Vide	60	9810000001	1

## MODULE MOUSSE FRAPPE 7 OUTILS

1 rivoir de 32 hickory / 1 maillet à embouts plastique 32 / 1 burin de mécanicien 200 / 1 pointeau corps moleté 6 / 3 chasse goupilles de 4, 5 et 6.



Contenu	▲ g	Ref.	☐
7 pcs	1570	9812007001	1
Vide	60	9812000001	1

## MODULE MOUSSE FRAPPE 7 OUTILS - CARBON

1 rivoir de 40 Carbon / 1 maillet à embouts plastique 32 / 1 burin de mécanicien 200 / 1 pointeau corps moleté 6 / 3 chasse goupilles de 4,5 et 6.



Carbon

Contenu	▲ g	Ref.	☐
7 pcs	1950	9813007001	1
Vide	60	9813000001	1

## MODULE MOUSSE JEU DE 2 EXTRACTEURS INTEX

1 extracteur 2 tonnes //  
1 extracteur 5 tonnes.



Contenu	▲ g	Ref.	☐
2T + 5T	1900	0770000101	1

## MODULE MOUSSE VIDE POCHE



▲ g	Ref.	☐
60	9814000001	1

## MODULE DE CALAGE MOUSSE POUR BASELINER ET PROLINER



▲ g	Ref.	☐
20	9554000301	1



16



62



96



120



126



156



188



224



248



254



300



316



340



390



462



488



29



# ACCESSOIRES SERVANTE



## ACCESSOIRES POUR GAMME LINER

### QUALITE

- En tôle épaisseur 0,8 mm, pliés et soudés.
- Peinture époxy noire.
- Fixation sur les côtés des servantes par crochets.

### GAMME

- Poubelle
- Porte-documents
- Porte-rouleau
- Porte-flacons
- Jeu 10 diviseurs de tiroirs
- Jeu 3 diviseurs

Toutes les servantes de la gamme Liner sont livrées avec un jeu de stickers (pictos, couleurs, initiales et chiffres)



### PORTE-FLACONS



Dimensions mm	g	Ref.	
110x250x69.5	490	9513070601	1

### PORTE-DOCUMENT



Dimensions mm	g	Ref.	
250x250x69.5	930	9513071001	1

### POUBELLE



Dimensions mm	g	Ref.	
300x300x182	1755	9513070701	1

### PORTE-ROULEAU



H mm	g	Ref.	
20	1040	9513071101	1

### DIVISEUR DE TIROIR



H mm	L mm	g	Ref.	
60 mm - Jeu de 10	396	1580	9513070801	1
120 mm - Jeu de 3	396	1050	9513070901	1

### CADENAS



Ø mm	g	Ref.	
2,5	90	9605000001	1

### PLANCHE STICKERS

Pour servantes et Fusion Box.



Dim. cm	g	Ref.	
21x29,7	10	9000000001	1





## COMPOSITION DE 109 PIÈCES POUR SERVANTES

- Réf 9542** - 24 douilles et accessoires 1/2 :
- douilles 6 pans (8-9-10-11-12-13-14-15-16-17-18-19-21-22-24-27-30-32 mm)
  - 1 poignée coulissante de 250 mm
  - 1 cliquet / 1 cardan
  - 1 douille à bougie 6 pans
  - 2 rallonges 125 et 250 mm
- Réf 9541** - 38 douilles et accessoires 1/4 :
- douilles 6 pans (5,5-6-7-8-9-10-11-12-13-14 mm)
  - poignée coulissante de 115 mm
  - 1 cliquet 1/4 / 1 cardan
  - 2 rallonges 50 et 125 mm
  - 13 douilles tournevis (PH1-PH2-PH3-H3-H4-H5-H6-PZ1-PZ2-0,6x4-1x5,5-1,2x7-1,6x8)
  - 1 jeu de 9 clés mâles
- Réf 9549** - 7 tournevis (5F+2PZ)
- Réf 9552** - 9 outils de frappe :
- 1 rivoir de 32 hickory
  - 1 maillet à embouts plastique de 32
  - 1 burin de mécanicien 200
  - 1 pointeau corps moleté
  - 3 chasse goupilles de 4, 5 et 6
  - 1 réglé inox de 20 cm
  - 1 tracette carbure
- Réf 9547** - 16 clés mixtes (6-7-8-9-10-11-12-13-14-15-16-17-18-19-22-24 mm)
- Réf 9544** - 5 clés mixtes (22-24-27-30-32 mm)
- Réf 9550** - 1 pince étaux + 1 multiprise
- Réf 9551** - 4 pinces bi-matière :
- 1 pince universelle de 180 mm
  - 1 pince coupante diagonale de 180 mm
  - 1 pince à becs plats de 170 mm
  - 1 pince à becs demi-ronds de 170 mm
- Réf 9551** - 4 pinces circlips



### SERVANTES GARNIES 109 PIÈCES

9 modules thermoformés.  
3 tiroirs garnis.



	kg	Ref.	☐
1 - Baseliner	69	9515109601	1
2 - Proliner	74	9516109701	1



## COMPOSITION 141 PIÈCES POUR SERVANTES

- Réf 9547** - 12 clés mixtes (8-9-10-11-12-13-14-16-17-18-19-22 mm)
- Réf 9565** - 10 clés à pipe 6x6 (8-10-11-12-13-14-16-17-18-19 mm)
- Réf 9550** - 1 pince multiprise + 1 clé à molette de 200 mm
- Réf 9551** - 4 pinces bimatériau
- 1 pince universelle de 180 mm
  - 1 pince coupante diagonale de 180 mm
  - 1 pince à becs plats de 170 mm
  - 1 pince à becs demi-ronds de 170 mm
- Réf 9550** - 1 pince à sertir + 1 coupe-tout + 1 boîte de 30 cosses
- Réf 9549** - 7 tournevis (5 fentes+ 2 PZ)
- Réf 9549** - 1 tournevis fente isolé 1000V + 1 testeur + 5 tournevis micro (3 fentes+2PH)
- Réf 9561** - 61 douilles et accessoires 1/4
- douilles 6 pans de 3.2 à 14 mm
  - 1 poignée coulissante
  - 1 cliquet
  - 1 cardan
  - 2 rallonges 50 et 125 mm
  - 1 étui de 9 clés mâles
  - 30 embouts
  - 1 tournevis porte-embouts
  - 1 douille porte-embouts
  - 1 embout porte-douilles
- Réf 9562** - 23 douilles et accessoires 1/2
- douilles 6 pans : 10-11-12-13-14-15-16-17-18-19-20-21-22-24-27-30-32 mm
  - 1 poignée coulissante
  - 1 cliquet
  - 1 cardan
  - 2 rallonges 125 et 250 mm
  - 1 adaptateur 1/2" => 3/8"
- Réf 6247** - 1 cutter
- Réf 6251** - 1 niveau rectangulaire
- Réf 6270** - 1 mesure de 3m

- Réf 9552** - 9 outils de frappe
- 1 rivoir de 32 hickory
  - 1 maillet à embouts plastique de 32
  - 1 burin de mécanicien 200 mm
  - 1 pointeau corps moleté
  - 3 chasse goupilles de 4, 5 et 6
  - 1 réglé inox de 20 cm
  - 1 tracette carbure



### SERVANTES GARNIES 141 PIÈCES

12 modules thermoformés.  
4 tiroirs garnis.



	kg	Ref.	☐
1 - Baseliner	81	9515141601	1
2 - Proliner 5T	85	9516141501	1
3 - Proliner 7T	86	9516141701	1

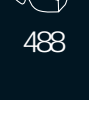



# SERVANTES GARNIES

## COMPOSITION DE 156 PIÈCES POUR SERVANTES - 14 MODULES

- Ref 9547 - 16 clés mixtes (6-7-8-9-10-11-12-13-14-15-16-17-18-19-22-24 mm)
- Ref 9544 - 5 clés mixtes (22-24-27-30-32 mm)
- Ref 9565 - 10 clés à pipe 6x6 (8-10-11-12-13-14-16-17-18-19 mm)
- Ref 9551 - 4 pinces bi-matière :
  - 1 pince universelle de 180 mm
  - 1 pince coupante diagonale de 180 mm
  - 1 pince à becs plats de 170 mm
  - 1 pince à becs demi-ronds de 170 mm
- Ref 9551 - 4 pinces circlips
- Ref 9550 - 1 pince étaux + 1 multiprise
- Ref 9549 - 7 tournevis (élec + méca)
- Ref 9549 - 7 tournevis (PH + PZ + méca avec écrou)
- Ref 9549 - 7 tournevis Torx
- Ref 9542 - 24 douilles et accessoires 1/2 :

- douilles 6 pans (8-9-10-11-12-13-14-15-16-17-18-19-21-22-24-27-30-32 mm)
- 1 poignée coulissante de 250 mm
- 1 cliquet / 1 cardan / 1 douille à bougie 6 pans
- 2 rallonges 125 et 250 mm
- Ref 9541 - 38 douilles et accessoires 1/4
- douilles 6 pans (5,5-6-7-8-9-10-11-12-13-14)
- poignée coulissante de 115 mm
- 1 cliquet 1/4 cardan / 2 rallonges 50 et 125 mm
- 13 douilles tournevis (PH1-PH2-PH3-H3-H4-H5-H6-PZ1-PZ2-0,6x4-1x5,5-1,2x7-1,6x8)
- 1 jeu de 9 clés mâles
- Ref 9552 - 9 outils de frappe :
  - 1 rivoir de 32 hickory
  - 1 maillet à embouts plastique de 32
  - 1 burin de mécanicien 200

- 1 pointeau corps moleté
- 3 chasse goupilles de 4, 5 et 6
- 1 réglé inox de 20 cm / 1 tracette carbure
- Ref 9558 - Outils de coupe :
  - 1 scie métaux METALCUT
  - 5 lames de scies HSS000
  - 1 cutter 18 mm
  - 10 lames de rechange cutter
  - 1 mesure 3 m
- Ref 9553 - 5 limes bi-matière :
  - 1 lime plate à main 200 mm batarde
  - 1 lime mi-ronde 200 mm mi-doux
  - 1 lime carrée 200 mm mi-doux
  - 1 lime triangulaire 200 mm mi-doux
  - 1 lime ronde 200 mm mi-doux



## COMPOSITION DE 126 PIÈCES MOUSSE POUR SERVANTES - 8 MODULES

- Ref 9800 - 17 clés mixtes : 6-7-8-9-10-11-12-13-14-15-16-17-18-19-21-22-24 mm
- Ref 9801 - 5 clés mixtes (27-28-29-30-32 mm)
- Ref 9808 - 3 pinces bimatière :
  - 1 pince universelle de 180 mm
  - 1 pince coupante diagonale de 160 mm
  - 1 pince à becs demi-ronds de 200 mm
- Ref 9807 - 1 pince étaux + 1 multiprise
- Ref 9805 - 8 tournevis : 6 fentes 2.5 / 3.5 / 4 / 5.5 / 6.5 / 8 mm + 2 Phillips PH1 PH2

- Ref 9804 - 23 douilles et accessoires 1/4
- 18 douilles 6 pans 8-9-10-11-12-13-14-15-16-17-18-19-21-22-24-27-30-32 mm
- 1 poignée coulissante de 250 mm
- 1 cliquet / 1 cardan
- 2 rallonges 125 et 250 mm
- Ref 9803 - 59 douilles et accessoires 1/4
- 13 douilles 6 pans : 3,2-4-5-5,5-6-7-8-9-10-11-12-13-14 mm
- 1 poignée coulissante de 115 mm
- 1 cliquet - 1 cardan

- 2 rallonges 50 et 125 mm
- 1 jeu de 9 clés mâles / 30 embouts de vissage
- 1 poignée emmanchée / 1 douille porte-embouts
- Ref 9812 - 7 outils de frappe :
  - 1 rivoir de 32 hickory
  - 1 maillet à embouts plastique de 32
  - 1 burin de mécanicien 200 mm
  - 1 pointeau corps moleté 6 mm
  - 3 chasse goupilles de 4, 5 et 6
  - + 1 cutter - 1 mesure



## COMPOSITION DE 173 PIÈCES MOUSSE POUR SERVANTES - 13 MODULES

- Ref 9800 - 17 clés mixtes (6-7-8-9-10-11-12-13-14-15-16-17-18-19-21-22-24 mm)
- Ref 9801 - 5 clés mixtes (27-28-29-30-32 mm)
- Ref 9802 - 13 clés à pipe 6x6 (7-8-9-10-11-12-13-14-15-16-17-18-19 mm)
- Ref 9808 - 3 pinces bimatière :
  - 1 pince universelle de 180 mm
  - 1 pince coupante diagonale de 160 mm
  - 1 pince à becs demi-ronds de 200 mm
- Ref 9809 - 4 pinces circlips
- Ref 9807 - 1 pince étaux + 1 multiprise
- Ref 9805 - 8 tournevis (6 fentes + 2 Phillips)
- Ref 9806 - 7 tournevis Tamper Torx
- Ref 9804 - 23 douilles et accessoires 1/4
- douilles 6 pans (8-9-10-11-12-13-14-15-

- 16-17-18-19-21-22-24-27-30-32 mm)
- 1 poignée coulissante de 250 mm
- 1 cliquet / 1 cardan
- 2 rallonges 125 et 250 mm
- Ref 9803 - 59 douilles et accessoires 1/4
- douilles 6 pans (3,2-4-5-5,5-6-7-8-9-10-11-12-13-14)
- poignée coulissante de 115 mm
- 1 cliquet / 1 cardan
- 2 rallonges 50 et 125 mm
- 1 jeu de 9 clés mâles / 30 embouts de vissage
- 1 poignée emmanchée / 1 douille porte-embouts
- Ref 9812 - 7 outils de frappe :
  - 1 rivoir de 32 hickory
  - 1 maillet à embouts plastique de 32
  - 1 burin de mécanicien 200 mm

- 1 pointeau corps moleté
- 3 chasse goupilles de 4, 5 et 6
- Ref 9810 - Outils de coupe :
  - 1 scie métaux METALCUT
  - 5 lames de scies HSS000
  - 1 cutter 18 mm
  - 10 lames de rechange cutter
  - 1 mesure 3m / 1 tracette carbure avec clip
  - 1 réglé inox 200 mm
  - 1 lime plate à main 200 mm batarde
  - 1 lime mi-ronde de 200 mm mi-doux
  - 1 lime triangulaire de 200 mm mi-doux
  - 1 lime carrée 200 mm mi-doux
  - 1 lime ronde de 200 mm mi-doux





16

## SERVANTES GARNIES - 156 PIÈCES

14 modules thermoformés.  
5 tiroirs garnis.



	kg	Ref.	📦
1 - Baseliner	81	9515156601	1
2 - Proliner 6T	85	9516156601	1
3 - Proliner 7T	86	9516156701	1



62



96



120



126



156

## SERVANTES GARNIES - 126 PIÈCES

8 modules mousse.



	kg	Ref.	📦
1 - Proliner 6T	75	9516126601	1
2 - XLiner 7T	116	9519126601	1



188



224



248



254



300

## SERVANTES GARNIES - 173 PIÈCES

13 modules mousse.



	kg	Ref.	📦
1 - Baseliner	81	9515173601	1
2 - Proliner 6T	8	9516173601	1
3 - Proliner 7T	86	9516173701	1
4 - XLiner 7T XLarge	116	9518173701	1
5 - XLiner 6T Armoire		9522173601	1



316

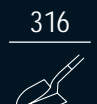

340



390



462



488

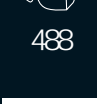

33



# COFFRES DE CHANTIER



## COFFRES DE CHANTIER

### QUALITE

Tôle épaisse pour une grande rigidité  
 550mm : fond = 0.90mm, couvercle = 1.10mm  
 670mm : fond = 1mm, couvercle = 1.20mm  
 850mm : fond = 1.10mm, couvercle = 1.30mm

- Ouverture du couvercle à 90°

- Plateau amovible coulissant  
 380 x 300 x 80 mm

3 dimensions - 3 volumes  
 550x300x300 mm - 50 L  
 670x350x350 mm - 80 L  
 850x350x350 mm - 105 L



1 fermail  
 Cadenassable  
 (Ø 10mm)

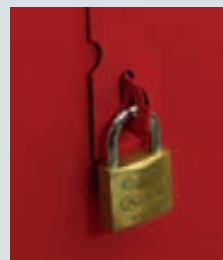

2 poignées

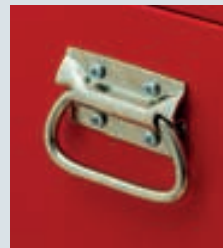

### COFFRE DE CHANTIER 550 mm

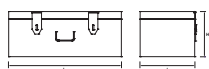

L mm	H mm	l mm	Vol. litre	kg	Ref.	☐
550	300	300	50 L	8	9589010001	1

### COFFRE DE CHANTIER 670 mm

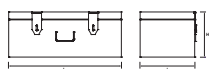

L mm	H mm	l mm	Vol. litre	kg	Ref.	☐
670	350	350	80 L	12,50	9589020001	1

### COFFRE DE CHANTIER 850 mm

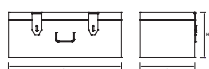

L mm	H mm	l mm	Vol. litre	kg	Ref.	☐
850	350	350	105 L	15,30	9589030001	1





## BOÎTES À OUTILS BICOLORES

### RÉSISTANCE

- Rivets renforcés
- Poignée tubulaire
- Caisson rigide
- Peinture epoxy
- Épaisseur de tôle 0,8 mm

### PRATIQUE

- Fermeture par cadenas possible
- Grande ouverture
- Ouverte ne bascule pas
- Tapis de protection

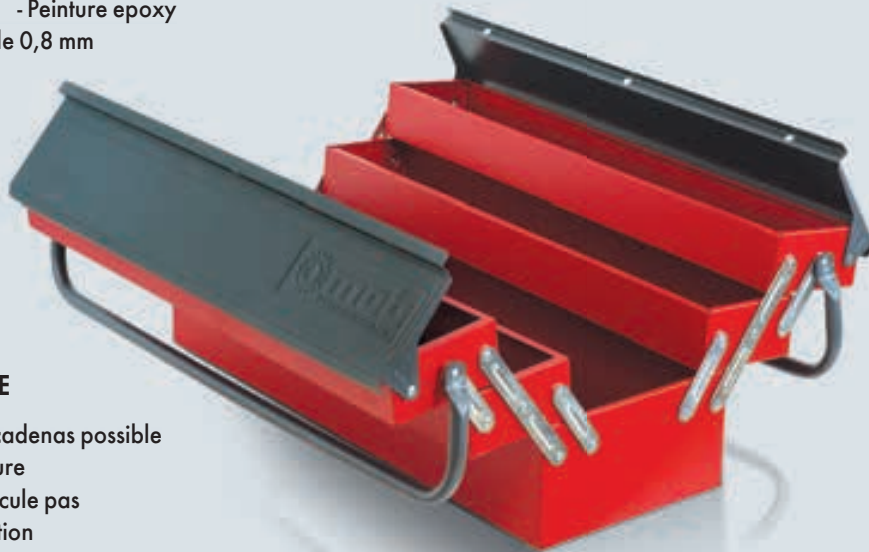

**ROBUSTESSE**  
rivets renforcés



Tapis dans chaque compartiment



### EN OPTION :

Ranger vos douilles et accessoires grâce à nos modules thermoformés spécial boîte à outils



Réf du kit des 2 modules pleins  
9557022001

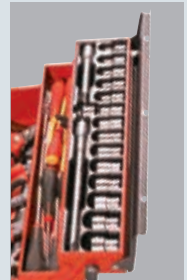

### BOÎTE À OUTILS 5 COMPARTIMENTS BICOLORE

- Marquage MOB embouti - peinture texturée bicolore
- tapis dans chaque compartiment.

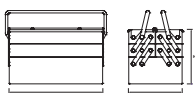

L mm	l mm	H mm	kg	Ref.	cube
450	200	200	4	9501000001	1
530	200	200	5,6	9501000101	1

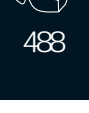



# BOÎTES À OUTILS

## BOÎTE À OUTILS 1 COMPARTIMENT BICOLORE

Marquage MOB embouti - peinture texturée bicolore - tapis.



L mm	l mm	H mm	▲ g	Ref.	☐
450	200	100	3070	9505000001	1

## BOÎTE À OUTILS 3 COMPARTIMENTS BICOLORE

Marquage MOB embouti - peinture texturée bicolore - tapis dans chaque compartiment.

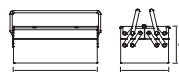
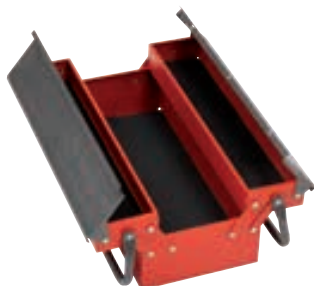

L mm	l mm	H mm	▲ g	Ref.	☐
450	200	155	3800	9500000001	1
530	200	255	4815	9500000101	1

## 2 MODULES POUR BOITE A OUTILS 450 MM

Douilles, cliquets et accessoires, 22 pièces - pour boîtes à outils 9501.



Exemple d'aménagement

	L mm	▲ kg	Ref.	☐
22 pcs	450 mm	3	9557022001	1
Vide pour cliquet et acc.		105	9555000001	1
Vide pour douilles		105	9556000001	1

## BOÎTE À OUTILS 5 COMPARTIMENTS "BASIC"

Epaisseur de tôle 0,5 mm. Poignées demi-tube.



L mm	l mm	H mm	▲ kg	Ref.	☐
430	200	200	4	9504000010	1
530	200	200	4,5	9501000110	1



## BOÎTES À OUTILS PLASTIQUE

2 FERMETURES MÉTALLIQUES

RANGEMENT

3 compartiments pour le rangement de petites pièces



3 compartiments

Plateau amovible  
Poignée escamotable  
Cadenassable



2 compartiments amovibles



1 compartiment pour les embouts



## BOITE À OUTILS PLASTIQUE BASIC

2 fermetures métalliques.

Plateau amovible à l'intérieur.

3 compartiments pour le rangement de petites pièces : 2 amovibles + 1 compartiment pour les embouts. Poignée escamotable. Cadenassable.



L mm	l mm	H mm	Charge maximum kg	▲ g	Ref.	☐
335	185	130	6	625	9506000101	1
415	210	190	12	1115	9506000201	1
480	250	230	15	1590	9506000301	1



## BOITE À OUTILS FLEX

### COMPACTE

Boîte à outils textile compacte  
 Pliable  
 Nombreuses poches  
 Bandoulière amovible  
 Patins de protection  
 Textile indéchirable 600 Deniers  
 Dimensions intérieures :  
 L38,5 x l19 x H17,5 cm  
 Volume : 13 L  
 Poignée en tube métallique avec  
 grip en mousse dense bicolore.



### BOÎTE À OUTILS FLEX

Pliable. Compact.



L mm	l mm	H mm	g	Ref.	📦
415	210	290	1600	9578000001	1



## EASY BAG S

### PRATIQUE

Soute de rangement petites pièces et quincaillerie

### TRANSPORT

Poignée mousse confortable.  
 Bandoulière réglable  
 avec fourreau antidérapant.

### RÉSISTANT ET LÉGER

Rabat de protection.  
 Côtés renforcés.  
 Volume: 12 L (9 L sans la soute)  
 Dimensions intérieures: L36x19xH19 cm

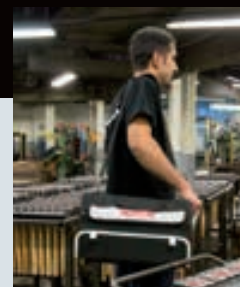

### EASY BAG S

Avec soute.  
 Volume : 12 L.  
 Capacité de charge : 11 kg.



L mm	l mm	H mm	g	Ref.	📦
420	190	240	2340	9570000001	1



16



62



96



120



126



156



188



224



248



254



300



316



340



390



462



488



37



# RANGEMENT TEXTILE



## EASY BAG MEDIUM

### PRATIQUE

Multiples poches intérieures et latérales.  
Nouvelles poches intérieures élastiques pour un rangement facilité

### TRANSPORT FACILITÉ

Poignée mousse confortable.  
Bandoulière réglable avec fourreau antidérapant.

### RÉSISTANT ET LÉGER

Base en polypropylène à patins 1,7 cm  
Poignée : barre métal surmoulée  
Toile 600 Deniers résistante à l'usure et aux accros  
Rabat de protection. Côtés renforcés.

### IMPERMÉABILITÉ

Fond étanche grâce à sa base en polyéthylène de 4,7 cm.  
Volume : 22 L  
Dimensions intérieures : L44xI20.5xH24 cm



## EASY BAG MEDIUM FRESH LINE

Fond étanche.  
Volume : 22 L.  
Capacité de charge : 15 kg.



L mm	I mm	H mm	g	Ref.	📦
510	260	370	2000	9772000001	1



## CLOSED BAG

### PRATIQUE

- Grand volume intérieur : 37,5 L /  
Dimensions : L44xI25xH36 cm  
- Nombreuses poches de rangement :  
16 intérieures et 11 extérieures.  
- 2 «tapeholders» (boucle métal pour mesure).  
- Forme pratique pour les articles encombrants  
ou volumineux.  
- Poignée souple + bandoulière réglable  
- Base en polyéthylène étanche sur 4,7 cm

### TEXTILE RÉSISTANT

- Toile 600 deniers, résistante à l'usure et aux accros.

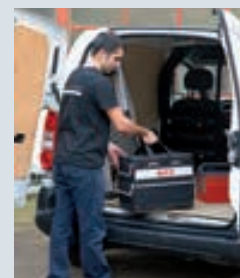

## CLOSED BAG FRESH LINE

Grand volume.  
Volume : 37,5 L.  
Capacité de charge : 35 kg.



L mm	I mm	H mm	g	Ref.	📦
440	250	360	2805	9576000001	1





## DUOBAG

### 2 ZONES DE RANGEMENT

- 1 côté qui accueille les outils, chaque outil est à sa place, à la verticale.
- 1 côté type « soute » qui peut accueillir une perceuse et son chargeur ou un PC portable 15" et des documents.

### NOMBREUX RANGEMENTS

- Facing : 1 poche fermée avec zip pour le rangement des clés, téléphones portables...
- Intérieur : 13 poches + 12 sangles élastiques pour clés, pinces, tournevis, embouts, mesures... + 1 grand vide poche pour électroportatif ou PC portable
- Extérieur : 2 poches latérales ouvertes. L'ouverture large par zips permet un bon dégagement et une bonne accessibilité des outils (même d'une scie).

### GRANDE RÉSISTANCE

- Textile 1200 deniers encore plus résistant à l'usure et aux accrocs
- Zips résistants YKK - Fond étanche

### TRANSPORT FACILITÉ

- À la main avec la poignée métal surmoulée
- Ou à l'épaule grâce à la bandoulière réglable.

Dimensions : 450 x 200 x 365 mm

DUOBAG



## DUOBAG

DUOBAG

Boîte à outils avec deux zones de rangement.

L mm	l mm	H mm	g	Ref.	📦
450	200	365	2640	9591000001	1



## SAC ÉTANCHE SLIM'BAG

### MATIÈRE PVC

- Sac conçu en matière PVC, ce qui le rend plus résistant dans les espaces humides ou s'il y a un risque de projections d'eau et dans les espaces poussiéreux ou sales : plus facile à laver.

### RANGEMENT

- Le format du sac permet de ranger des outils longs ou encombrants comme une scie, une clé stillson, un niveau... (longueur maxi 50 cm)
- 1 poche fermée par zip dans le couvercle pour accueillir documents, clés, stylos, téléphones
- 4 poches intérieures pour le rangement du petit outillage : pinces, clés, tournevis, clés mâles..., et 1 boucle pour mesure.

### TRANSPORT

- Transport par sangle bandoulière réglable.
- Fermeture par 2 clips plastiques réglables.

SlimBag

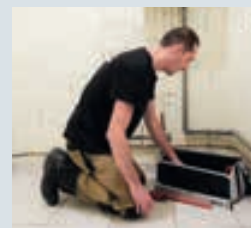

## SAC ÉTANCHE SLIM'BAG

SlimBag

Boîte à outils textile en PVC.  
Volume 10 L.  
Capacité de charge : 19 kg.

L mm	l mm	H mm	g	Ref.	📦
540	170	225	1715	9592000001	1



16



62



96



120



126



156



188



224



248



254



300



316



340



390



462



488



39



# RANGEMENT TEXTILE



## SAC À DOS

### RANGEMENT

- Nombreuses poches de rangement.
- Housse pour téléphone.

### TRIPTYQUE PORTE-OUTILS

Composé de 3 panneaux porte-outils, avec chacun 8 poches et 10 élastiques.

Amovible: détachable par scratch.

Volume : 21 L

Charge maximum: 30 kg

Dimensions : 350 x 200 x 450



## SAC À DOS FRESH LINE

Avec porte-outils amovible.

Volume : 21 L.

Capacité de charge : 15 kg.



L mm	l mm	H mm	g	Ref.	📦
350	200	450	1925	9575000001	1



## TROLLEY BAG - BOÎTE À OUTILS SUR ROULETTES

### GRANDE MANIABILITÉ

- Système trolley hauteur 1010 mm.
- Roues robustes et extra larges Ø 40 mm = Stabilité améliorée.
- Poignée à main en relais.

### PRATIQUE

- Ouverture à soufflet à 100 %.
- Nombreuses poches de rangement : 15 poches intérieures et 10 poches extérieures.
- 2 "tapeholders" (boucle métal pour mesure).
- Fermeture à glissière de protection.

### RÉSISTANT

- Base synthétique dure + 4 patins élastomère.
- Textile à 1200 deniers, encore plus résistant à l'usure et aux accrocs.
- Capacité de chargement élevé : 68 kg - Volume : 44 L
- Dimensions intérieures : L45 x l25 x H39 cm.



## TROLLEY BAG

Volume 44 L.

Capacité de charge : 68 kg.



L mm	l mm	H mm	g	Ref.	📦
480	245	395	3500	9574000001	1



## TROUSSE ZIPPÉE

12 emplacements.



Lxl mm	g	Ref.	📦
195x320	375	958000001	1



## EASY JACKET

### PRATIQUE

- Nombreuses poches et attaches astucieuses
- Léger : 590 g
- Taille ajustable : 4 possibilités de réglage
- Fermeture à glissière

### SOLIDE

- Tissu polyester 600D indéchirable
- Idéal pour travailler à l'extérieur

### POCHES

- Poche transparente pour carte de visite
- Poches ouvertes : tournevis, clés, crayons
- Boucle mousqueton pour clés
- Poches fermées : carnet de chantier, mesure, vis, clous, pointes...



## EASY JACKET

Taille : universelle.



L mm	H mm	g	Ref.	📦
480	660	590	9587000001	1

## CEINTURE PORTE-OUTILS

Composée d'une ceinture sangle et cuir, d'un soutien lombaire, d'une poche porte-outils et d'un porte marteau.



g	Ref.	📦
870	6441000101	1

## PORTE-OUTILS ÉLECTROPORTATIF



g	Ref.	📦
160	6444000001	1

## PORTE-OUTILS TEXTILE

2 poches principales.  
2 porte-couteaux latéraux.



Dimensions mm	g	Ref.	📦
300x250x125	525	6446000001	1

## CEINTURE CUIR GRAS

Tanné avec huiles apportant imperméabilité, facilité d'entretien et durabilité, sans toucher gras - épaisseur 3 mm - color brun foncé.



g	Ref.	📦
305	00004100LB	1

## CEINTURE POUR POUCHES

Pour réf. 805010 - 805020 - 805030 - 805210. Sangle tressée synthétique.



Ref.	📦
805150	1

## PORTE MARTEAU EASY FIX

Boucle métallique traitée anti-corrosion - grand passant ceinture - textile 600 Deniers - idéal pour les marteaux de 250 à 500 g.



L mm	l mm	g	Ref.	📦
190	120	70	9588000001	1

## PORTE-MARTEAU

En cuir rigide. Boucle métallique.



Ref.	📦
805100	1



16



62



96



120



126



156



188



224



248



254



300



316



340



390



462



488



41



# PORTE-OUTILS



## POCHE CUIR TANNÉ

### LES PLUS

- Cuir velours de très belle qualité
- Rivetage très résistant



### CARACTÉRISTIQUES

- 11 poches pour outils
- 1 porte mesure
- 2 porte-marteaux
- 1 support équerre.



## POCHE DOUBLE EN CUIR TANNÉ AVEC CEINTURE

Cuir velours, belle qualité.  
Rivetage très résistant.  
11 poches pour outils.  
1 porte mesure.  
2 porte-marteaux et  
1 support équerre.



Ref.	
805200	1

## POCHE SIMPLE EN CUIR TANNÉ

Cuir velours. Rivetage très résistant.  
6 poches pour outils. 1 porte  
marteau et 1 support équerre.



Ref.	
805210	1



## POCHE DOUBLE AVEC CEINTURE

### QUALITÉ

- En cuir souple, riveté
- Une boucle porte-marteau en cuir rigide, une boucle métal porte-outils
- 11 poches dont une centrale en cuir rigide pour mesure et un support équerre.



## POCHE DOUBLE AVEC CEINTURE

En cuir souple, riveté.  
3 boucles, 11 poches.



Ref.	
805000	1

## POCHE À OUTILS GRAND MODÈLE

En cuir souple, riveté.  
8 poches et 2 porte-  
marteaux.



Ref.	
805010	1

## POCHE À OUTILS PETIT MODÈLE

En cuir souple, riveté.  
2 poches.



Ref.	
805020	1

## POCHE DE COUVREUR

En cuir souple, riveté.  
2 poches.



Ref.	
805030	1

## POCHE À CLOUS AVEC CEINTURE

En cuir souple. 2 poches.



Ref.	
805080	1



## VALISE ALUMINIUM

Coins de renforts arrondis.

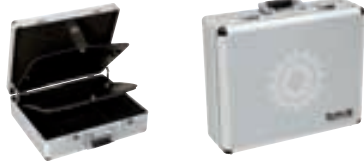

L mm	l mm	H mm	▲ g	Ref.	☐
490	400	155	5185	9534000001	1

## VALISE TROLLEY ALUMINIUM VIDE

Avec système trolley.  
Coins de renforts arrondis.  
2 panneaux porte-outils pré-équipés fixes.  
Soute avec séparateur amovible.



L mm	l mm	H mm	▲ kg	Ref.	☐
490	400	155	5,2	9535000001	1



16



62



96



120



126



156



188



224



248



254



300



316



340



390



462



488



43



## VALISE ABS TROLLEY

### INTÉGRÉ

Système trolley intégré : non-dépassant, il se glisse partout sans s'accrocher (soute d'avion, entre 2 sièges...) et reste à l'abri des chocs.

### QUALITÉ

- Volume en ABS : plastique léger et ultra-résistant aux chocs.
- Poignée bi-matière.
- Structure en aluminium.

### PRATIQUE

- 2 panneaux porte-outils pré-équipés.
- Soute avec séparateurs amovibles.
- Fermeture par clés

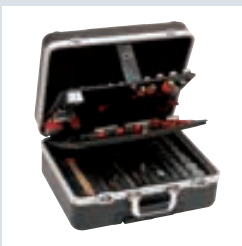

Exemple de composition



## VALISE TROLLEY ABS VIDE

Système trolley intégré.  
ABS plastique léger ultra-résistant.



L mm	l mm	H mm	▲ kg	Ref.	☐
465	420	230	6	9538000001	1

# FUSION BOX



Fusion Box, c'est un grand coffret appelé Cargo, équipé de rails, qui accueille par glissement d'autres coffrets de tailles différentes ou une trousse textile.



Coffret en PEHD (polyéthylène Haute Densité) très résistant.

## BREVETÉ



## COMMENT ASSEMBLER ?

1 CARGO



à choisir parmi les 3 modèles suivants :

CARGO  
VIDE



Réf. 9476000001

CARGO  
MULTI



Réf. 9476031001

CARGO  
DOUILLES



Réf. 9476070001



1 TROUSSE TEXTILE



1 COFFRET N°1 ET 1 COFFRET N°3



1 COFFRET N°2 ET 2 COFFRETS N°1  
OU 2 COFFRETS N°2



1 COFFRET N°3

## TEXTILE



Ref. 9477000001  
p. 48



Ref. 9477030001  
p. 49



Ref. 9477038001  
p. 49



Ref. 9477046001  
p. 49



Ref. 9435071001  
p. 49

## BOX N°3



Ref. 9435021001  
p. 84



Ref. 9435021101  
p. 84



Ref. 9435021201  
p. 84



Ref. 9435021301  
p. 84



Ref. 9436028001  
p. 85



Ref. 9436044001  
p. 110



Ref. 9436033001  
p. 76



Ref. 9436008001  
p. 165



Ref. 9436033101  
p. 76



Ref. 9436000001  
p. 46



Ref. 9350005001  
p. 182



Ref. 9420010001  
p. 77



Ref. 9436016001  
p. 161



Ref. 9436019001  
p. 337



Ref. 9436033201  
p. 86



Ref. 9420020001  
p. 215

## BOX N°2



Ref. 9002000101  
p. 161



Ref. 9002000201  
p. 105



Ref. 9003000101  
p. 109



Ref. 9028000000  
p. 86



Ref. 9426100001  
p. 72

## BOX N°1



Ref. 9415016001  
p. 74



Ref. 9415016101  
p. 74



Ref. 9415016201  
p. 74



Ref. 9415016301  
p. 74



Ref. 9416046101  
p. 75



Ref. 9416046001  
p. 73



Ref. 9416009001  
p. 337



Ref. 9416033001  
p. 155



Ref. 9416107001  
p. 155



Ref. 9416042001  
p. 124



Ref. 9050010001  
p. 125



Ref. 9416000101  
p. 46



# FUSION BOX



## COFFRETS FUSION BOX

### COFFRETS EN PEHD

- Les coffrets en Polyéthylène Haute Densité (PEHD) ont détrôné aujourd'hui le métal, car ils ne s'abîment pas aux chocs comme des coffrets métalliques, qu'il est nécessaire de débosser.
- Le dos des coffrets BOX est de plus traité avec des nervures de protection évoquant des dessins de pneus. ❶
- Des fermoirs métalliques résistants



### AMÉNAGEMENTS INTÉRIEURS

- 2 types : thermoformés, plus économiques, ou mousse haute densité bicolore, plus actuelle et pratique :
  - Idéal pour repérer les manquants
  - Un marquage blanc visible
  - Haute Densité résistante
  - Bonne tenue



### LE CARGO

- Le Cargo présente des rails injectés sur lesquels les autres coffrets viennent glisser. ❷
- Des butées permettent de verrouiller l'ensemble pendant le transport. Ses charnières triples sont renforcées par un jonc métal traversant.



### FUSION BOX N°3 VIDE



L mm	H mm	E mm	kg	Ref.	📦
405	225	60	1,045	9436000001	1

### FUSION BOX N°1 POUR VISSERIE

5 compartiments.



L mm	H mm	E mm	g	Ref.	📦
135	215	60	345	9416000101	1



# CARGO FUSION BOX



## FUSION BOX CARGO VIDE



L mm	H mm	E mm	kg	Ref.	☐
600	330	90	2,2	9476000001	1

## COFFRET FUSION BOX CARGO - MULTI' 31 PIECES



<ul style="list-style-type: none"> <li>9000 7-8-10-11-12-13-14-15-16-17-18-19-22-24 mm</li> <li>6482 240mm</li> </ul>	<ul style="list-style-type: none"> <li>9804 160mm</li> <li>9062 1,5-2-2,5-3-4-5-6-8-10 mm</li> </ul>	<ul style="list-style-type: none"> <li>9100 3,5x75-5,5x125 mm</li> <li>9101 6,5x150mm</li> </ul>	<ul style="list-style-type: none"> <li>9102 PH1-PH2</li> <li>0001 30mm Carbon</li> </ul>
---	--	--	--

31 pcs	Dimensions mm	kg	Ref.	☐
	600x330x90	5,55	9476031001	1

## FUSION BOX CARGO - 1/4"-1/2" 70 PIECES



<ul style="list-style-type: none"> <li>9200 Cliquet Premium rond</li> </ul>	<ul style="list-style-type: none"> <li>9265 Click'n hold 140mm</li> </ul>	<ul style="list-style-type: none"> <li>9272</li> </ul>	<ul style="list-style-type: none"> <li>919B PH0PH1-PH2-PH3</li> </ul>
<ul style="list-style-type: none"> <li>9210 4-5-6-7-8-9-10-11-12-13 mm</li> </ul>	<ul style="list-style-type: none"> <li>9202 Cliquet Premium rond</li> </ul>	<ul style="list-style-type: none"> <li>9262 125mm</li> </ul>	<ul style="list-style-type: none"> <li>919C PZ0PZ1-PZ2-PZ3</li> </ul>
<ul style="list-style-type: none"> <li>9250</li> </ul>	<ul style="list-style-type: none"> <li>9212 10-11-12-13-14-15-16-17-18-19-21-22-24-27-30-32 mm</li> </ul>	<ul style="list-style-type: none"> <li>9267 Click'n hold 280mm</li> </ul>	<ul style="list-style-type: none"> <li>919D T10-T15-T20-T25-T27-T30-T40</li> </ul>
<ul style="list-style-type: none"> <li>9270</li> </ul>	<ul style="list-style-type: none"> <li>9281 16-21 mm</li> </ul>	<ul style="list-style-type: none"> <li>9283</li> </ul>	<ul style="list-style-type: none"> <li>919E H1,5-H2-H2,5-H3-H4-H5-H6-H8</li> </ul>
<ul style="list-style-type: none"> <li>9260 75mm</li> </ul>	<ul style="list-style-type: none"> <li>9252</li> </ul>	<ul style="list-style-type: none"> <li>929A</li> </ul>	<ul style="list-style-type: none"> <li>919A 4-4,5-5-6,5-8mm</li> </ul>

70 pcs	Dimensions mm	kg	Ref.	☐
	600x330x90	6,3	9476070001	1



16



62



96



120



126



156



188



224



248



254



300



316



340



390



462



488



47



# TEXTILE FUSION BOX



## TEXTILE FUSION BOX

### AMÉNAGEMENTS

Face avant : 26 élastiques pour clés et tournevis  
Face arrière : 6 poches élastiquées pour pinces, cutters, lampes...

### CARACTÉRISTIQUES

- Textile 1200 D anti-déchirure
- Poignée élastomère
- 2 zips
- Plaque et rails en plastique injecté
- Poche extérieure
- Verrouillage par sangle



### TEXTILE FUSION BOX VIDE

32 emplacements dont  
26 élastiques et 6 poches  
élastiquées.



Lxl mm  
500x330

g  
2255

Ref.  
947700001

1

# TEXTILE FUSION BOX



## FUSION BOX TEXTILE LES ESSENTIELS 30 PIÈCES

Peut se glisser dans les rails d'un Cargo Fusion Box.



9000 8-10-11-12-13-16-17-18-19mm	9105 160mm	9108 PZ1 - PZ2	6247 18mm
9044 200mm	9062 1,5-2-2,5-3-4-5-6-8-10mm	0001 30mm	6270 3 m
6480 240mm	9100 3,5x75-4x100-5,5x125	6309	

30 pcs	Dimensions mm	kg	Ref.	1
	500x330x120	6,07	9477030001	

## FUSION BOX TEXTILE GARNI PLOMBERIE

Peut se glisser dans les rails d'un Cargo Fusion Box.



9005 6x7-8x9-10x11-12x13-14x15-16x17-18x19-21x23-22x24 mm	9101 6,5x150-8x150mm	9805 160mm	6493 3-42mm
9044 250mm	9102 PH1 - PH2	6480 240mm	6496 30mm
9100 3,5x75-5,5x125 mm	9103 PZ1 - PZ2	6270 3 m	6495 3-42mm
	9100 4x100mm	6247 18mm	0000 28mm
	9062 1,5-2-2,5-3-4-5-8-10 mm	9021 2'-450mm	0910 200mm mi-douce

38 pcs	Dimensions mm	kg	Ref.	1
	500x330x120	8.82	9477038001	

## FUSION BOX TEXTILE GARNI MAINTENANCE

Peut se glisser dans les rails d'un Cargo Fusion Box.



9000 7-8-9-10-11-12-13-14-16-17-19 mm	9108 PZ1 - PZ2	9062 1,5-2-2,5-3-4-5-6-8-10mm	6270 3 m
9100 4x100mm	9100 VDE 4x100x08 mm	9805 160mm	6285 200mm
9101 6,5x150-8x150mm	9100 3x55x08 mm	9804 180mm	7257
9102 PH1 - PH2	9160 2-2,5-3 mm	9801 200mm	0001 36 mm
	9162 PH0	6480 240mm	7253 6 mm
		6247 18mm	7258 23-4 mm

46 pcs	Dimensions mm	kg	Ref.	1
	500x330x120	6,07	9477046001	

## FUSION BOX TEXTILE GARNI ÉLECTRICITÉ

Peut se glisser dans les rails d'un Cargo Fusion Box.



9005 4x5-5x7-6x7-8x9-10x11-12x13-14x15-16x17-18x19 mm	9108 PZ1-PZ2	9805 160mm	9608 x30
9100 3,5x75x06-4x100x08-5,5x125x1-6,5x150x1,2 mm	9100	9804 180mm	6218
9102 PH1-PH2	9160 2-2,5-3 mm	9801 200mm	6217
	9162 PH0	6480 240mm	6270 3 m
	9062 1,5-2-2,5-3-4-5-6-8-10 mm	9871 160mm	0416 18mm
		9830	

71 pcs	Dimensions mm	kg	Ref.	1
	500x330x120	8,5	9477071001	



16



62



96



120



126



156



188



224



248



254



300



316



340



390



462



488



49



# COMPOSITION FUSION BOX

## COMPOSITION FUSION BOX 1/4 1/2 TEXTILE GARNI



### Composition :



 9200 Clicket Premium rond ∅1/4	 9265 Click'n hold 140mm ∅1/4	 9272 255mm ∅1/2	 919A 4-45-55 -6.5-8 mm
 9210 4-56-7-8-9- 10-11-12-13 mm	 9202 Clicket Premium rond ∅1/2	 9262 125mm ∅1/2	 919B PH0 - PH1 - PH2 - PH3
 9250 ∅1/4	 9212 10-11-12- 13-14-15- 16-17-18- 19-21-22- 24-27-30-32 mm	 9267 Click'n hold 280mm ∅1/2	 919C PZ0 - PZ1 - PZ2 - PZ3
 9270 115mm ∅1/4	 9281 Douille bougie 16-19mm ∅1/2	 9288 ∅1/4	 919D T10-T15- T20-T25- T27- T30-T40
 9260 75mm ∅1/4	 9252 ∅1/2	 929A ∅1/4	 919G TT10-TT20



 9000 7-8-9-10- 11-12-13- 14-16-17-19 mm	 9108 PZ1 - PZ2	 9362 1,5-2-25- 3-4-5-6-8- 10mm	 6270 3 m
 9100 4x100mm	 9100 4x100mm	 9805 160mm	 6285 200mm
 9101 6,5x150- 8x150	 9100 3x55xQ8 mm	 9804 180mm	 7257
 9102 PH1 - PH2	 9160 2-2,5-3 mm	 9801 200mm	 0001 36 mm
	 9162 PH0	 6480 240mm	 7253 6 mm
		 6247 18mm	 7258 23-4mm

116 pcs

1 cargo douilles (9476070001) + 1 textile (9477046001)

kg  
12,4

Ref.  
9499116001

1

# COMPOSITION FUSION BOX



## FUSION BOX X3 MULTI + 1/2 + 1/4 - 105 PIECES



### Composition :

9000 7-8-10-11-12-13-14-15-16-17-18-19-22-24 mm 	9304 160mm 	9100 3.5x75-5.5x125 mm 	9102 PH1-PH2 
6482 240mm 	9062 1.5-2-2.5-3-4-5-6-8-10 mm 	9101 6.5x150mm 	0001 30mm Carbon 



9202 	9281 16-21 mm 	9272 	9267 Click'n hold 280mm 
9212 8-9-10-11-12-13-14-15-16-17-18-19-20-21-22-23-24-27-28-30-32 mm 	9252 	9262 125mm 	



9200 	9260 50mm 	929A 	919D T10-T15-T20-T25-T27-T30-T40 
9210 5-6-7-8-9-10-11-12-13-14mm 	9260 150mm 	919A 4.4-5-5.5-6.5-8mm 	919E H1,5-H2-H2.5-H3-H4-H5-H6-H8-H10 
9250 	9283 	919B PH0PH1-PH2PH3 	919C 2x PZ0PZ1-PZ2-PZ3 

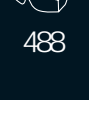

105 pcs	1 Cargo Multi 9176031001 + 1 Medium 1/2" 9436028001 + 1 Small 1/4" 9416046001	kg	Ref.	1
		11,03	9499105001	



# COMPOSITION FUSION BOX

FUSION BOX X3 MULTI + 1/2 + 1/4  
68 PIECES



## Composition :



9000 7-8-10-11- 12-13-14- 15-16-17- 18-19-22-24 mm	9100 3,5x75 - 5,5x125 mm	9102 PH1 - PH2	9804 160mm
	9101 6,5x150mm	9062 1,5-2-2,5- 3-4-5-6-8- 10mm	64E2 240mm
			0001 30mm



9202 Cliquet Paire	9212 8-10-11-12- 13-14-15- 16-17-18- 19-21-22- 24-27-30-32 mm	9252	9262 125 - 250 mm
--------------------------	---	------	-------------------------



9200 Cliquet Paire	9210 4-5-5,5-6-7- 8-9-10-11- 12-13-14 mm	9250	9260 50 - 125mm
--------------------------	--	------	--------------------

# COMPOSITION FUSION BOX



## FUSION BOX X3 MULTI + 1/2 + EMBOUTS 174 PIECES



### Composition :

9000 7-8-10-11-12-13-14-15-16-17-18-19-22-24 mm	9100 3,5x75 - 5,5x125 mm	9102 PH1 - PH2	9804 160mm
	9101 6,5x150mm	9062 1,5-2-2,5-3-4-5-6-8-10mm	6482 240mm
		0001 30mm	



9202 Cliquet Premium rond	9212 8-9-10-11-12-13-14-15-16-17-18-19-20-21-22-23-24-27-28-30-32 mm	9252	9267 Click'n Hold en 280mm
9281 16-21 mm	9262 125mm	9272	



9460 partie embout magnetique autoblock	919A 3,5-4-4,5-5,5x26,5,8 mm	919D T6-T7-T8-T9-T10x2-T15x2-T20x8-T25x2-T27-T30x3-T40x2-T50	919F 0-1-2-3 mm
9283	919B PH0x2-PH1x5-PH2x10-PH3x2-PH4	919G TT10-TT15-TT20-TT30-TT40	919I 4-6-8-10 mm
929A	919C PZ0-PZ1x5-PZ2x11-PZ3x2-PZ4	919E H1,5x2-H2x2-H2,5x2-H3x2-H4x3-H5x3-H6x2-H7-H8x2-H10	919K 5-6-8-10 mm
		919J 2-3-4 mm	



16



62



96



120



126



156



188



224



248



254



300



316



340



390



462



488

174 pcs	1 Cargo Multi 9476031001 + 1 Medium 1/2" 9436028001 + 1 Small embouts 9416107001	11,5 kg	Ref. 9499174001	1
---------	--	---------	-----------------	---



# COMPOSITIONS

## BOÎTE À OUTILS 5 CASES 450MM GARNIE 40 PIÈCES



9000 8-10-11-12-13-16-17-18-19mm	9102 PH1 - PH2	9805 160mm	7258 46 mm
9100 4x100-5,5x100 mm	9103 PZ1 - PZ2	9806 250mm	6309
9101 6,5x150-8x150mm	6482 240mm	9061 1,5-2-2,5-3-4-5-6-8-10 mm	6312 5lames HSS
	9804 180mm	7253 4mm	0001 36 mm

	Dimensions mm	kg	Ref.	
40 pcs	450x200x200	10,54	9501040101	1

## BOÎTE À OUTILS MÉCANIQUE 50 PIÈCES



9000 8-10-11-12-13-14-16-17-19mm	9102 PH1-PH2	9801 200mm	6251 40cm
9044 250mm	9103 PZ1-PZ2	6480 240mm	0001 32mm
9100 4x100	9062 1,5-2-2,5-3-4-5-6-8-10 mm	6369	7253 6 mm
9101 5,5x100-6,5x150-8x150mm	9805 160mm	6312 x5 lames Carbone	7258 3-4-5mm
	9804 180mm	6313 x5 lames HSS	0910 200mm
		6270 3 m	

	Dimensions mm	kg	Ref.	
50 pcs	450X200X200	10,25	9501050101	1

## BOITE À OUTILS MAINTENANCE 70 PIÈCES



9000 6-7-8-10-11-12-13-14-16-17-18-19 mm	9252	9103 PZ1 - PZ2	6350 220mm
9202	9272 255mm	9100 VDE 1000V 4x100mm	0861 210mm
9212 8-9-10-11-12-13-14-15-16-17-19-21-22-24 mm	9262 125 - 250 mm	9102 VDE 1000V PH1-PH2	6247 18mm
9281 16 - 21 mm	9292 1/2 > 3/8	9100	6218
	9100 3,5x75mm	9062 1,5-2-2,5-3-4-5-6-8-10 mm	6270 3 m
	9101 5,5x100-6,5x150-8x150	9805 160mm	6285 200mm
		9801 200mm	0001 36 mm Carbon
		9808 160mm	7210 200mm
		6480 240mm	7258 23-4-5mm
			0910 200mm

	Dimensions mm	kg	Ref.	
70 pcs	450x200x200	15	9501070101	1







## BOÎTE À OUTILS MAINTENANCE 93 PIÈCES



9000 8-10-11-12-13-14-16-17-18-19 mm	9292 1/2 > 3/8	9062 1,5-2-253-456-8-10 mm	6313 x5HSS O
9005 8x9-10x11-12x13-14x15-16x17-18x19 mm	9100 3,5x75-5,5x125 mm	9805 160mm	6312 x5HSS 000
9202 72 dents	9101 6,5x150-8x150mm	9804 180mm	6270 3 m
9212 8-9-10-11-12-13-14-15-16-17-19-21-22-24 mm	9102 PH1 - PH2	9801 200mm	6285 200mm
9281 16 - 21 mm	9103 PZ1 - PZ2	9808 160mm	7257
9252	9100 4x100mm	6480 240mm	0001 36 mm Carbon
9272 255mm	9102 PH1 - PH2	9820 19-60mm	0869 32mm
9262 125 - 250 mm	9100 3x55xQ8 mm	9822 19-60mm	7210 200mm
	9102 PH1 - PH2	6350 220mm	7258 23-4-5mm
	9100 3x55xQ8 mm	0861 210mm	6410
		6247 18mm	0910 200mm
		6218	
		6369	

	Dimensions mm	kg	Ref.	
<b>93 pcs</b>	450x200x200	15,63	9501093001	1

## BOITE À OUTILS PLASTIQUE 450MM GARNIE 30 PIÈCES

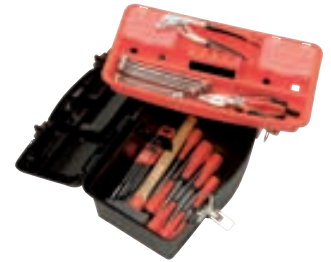

9000 8-10-11-12-13-16-17-18-19mm	9101 6,5x150-8x150mm	9103 PZ1 - PZ2	9804 180mm
9100 4x100-5,5x100 mm	9102 PH1 - PH2	9061 1,5 - 2 - 25 - 3 - 4 - 5 - 6 - 8 - 10mm	6482 240mm
		9805 160mm	0001 36 mm

	Dimensions mm	kg	Ref.	
<b>30 pcs</b>	450x260x220	4,965	9502030101	1

## BOITE À OUTILS PLASTIQUE GARNIE 25 PIÈCES



9000 8-10-12-13-16-17-19 mm	9101 6,5x150	6480 240mm	6270 3 m
9100 3,5x75 - 4x100	9102 PH1-PH2	9805 160mm	0001 32mm
		9062 1,5-2-253-456-8-10 mm	

	Dimensions mm	kg	Ref.	
<b>25 pcs</b>	480x250x230	6,7	9506025301	1

## TROUSSE TEXTILE ELECTRICIEN GARNIE 17 PIÈCES



9000 56-8-10-13-17 mm	9102 PH1-PH2	9808 160mm	6217
9044 200mm	9100 3x55xQ8 mm	6481 240mm	0416 18mm
9100 3,5x75-4x100mm		6218	

	Lxl mm	g	Ref.	
<b>17 pcs</b>	195x320	2020	9580016001	1



16



62



96



120



126



156



188



224



248



254



300



316



340



390



462



488



55



# COMPOSITIONS

## EASY BAG GARNI 24 PIÉCES

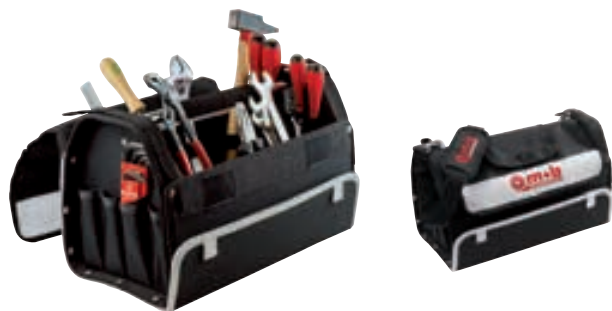

9000 8-10-13-17-19mm	9101 6,5x150mm	9062 1,5-2-2,5-3-4-5-6-8-10mm	6285 300mm
9044 250mm	9102 PH1 - PH2	9804 160mm	0001 30mm
9100 4x100mm		6480 240mm	0910 200mm

	Dimensions mm	kg	Ref.	
24 pcs	420x190x240	5	9570024001	1

## EASY BAG ÉLECTRICITÉ 47 PIÉCES



9005 4x5-5x7-6x7-8x9-10x11-12x13-14x15-16x17-18x19mm	9108 -VDE PZ1 - PZ2	9801 -VDE 200mm	0416 18mm
9044 250mm	9100 3x55xQ8mm	9808 -VDE 160mm	0136 1kg
9100 3,5x75xQ6mm	9062 1,5-2-2,5-3-4-5-6-8-10mm	6481 -VDE 240mm	7253 6mm
9100-VDE 3,5x75xQ6-4x100xQ8-5,5x125x1-6,5x150x1,2mm	9805 -VDE 160mm	6270 3m	7258 2-3-4mm
9102 -VDE PH1 - PH2	9804 -VDE 160mm	6218	7210 200mm
		6217	7170 300x16mm
		0001 32mm	6220 3cm

	Dimensions mm	kg	Ref.	
47 pcs	420x190x240	10	9570047001	1

## EASYBAG PLOMBERIE 53 PIÉCES



9005 6x7-8x9-10x11-12x13-14x15-16x17-18x19-21x23-22x24-26x28-27x29-30x32mm	9101 5,5x100-7x125-9x150mm	9806 250mm	9017 300mm
9044 250mm	9108 PZ1 - PZ2	6369	6493 3-42mm
9049 280mm	9061 1,5-2-2,5-3-4-5-6-8-10mm	6313 x5 -HSSO-300mm	6495 3-42mm
9100 3,5x75-4x100mm	9805 160mm	6312 x5 -HCS-300mm	6490 6-19mm
	6480 240mm	6275 3m	0200 30mm
		6251 40cm	0910 200mm
		9021 2'-18'/450mm	

	Dimensions mm	kg	Ref.	
53 pcs	510x260x370	15	9577053001	1

## SLIMBAG LES ESSENTIELS PLOMBERIE 25 PIÉCES



9008 8-10-13-17-19mm	9100 3,5x75mm	9108 PZ1-PZ2	6247
9048 Extra-large 34mm - L165mm	9101 5,5x100-6,5x150-8x150mm	9061 1,2-2-2,5-3-4-5-6-8-10mm	6270 3m
		6251 50cm	9805 160mm

	Dimensions mm	g	Ref.	
25 pcs	540 x 170 x 225	4,6	9592025001	1



## CLOSED BAG GARNI 40 PIÈCES



9000 8-10-11-12-13-16-17-18-19mm	9102 PH1 - PH2	9805 160mm	6312 x5HSS
9100 4x100-5,5x100mm	9108 PZ1 - PZ2	9804 180mm	7253 4mm
9101 6,5x150-8x150mm	9061 1,5-2,25-3-4-5-6-8-10mm	6482 240mm	7258 4 - 6 mm
		9806 250mm	0001 36 mm
		6309	

	Dimensions mm	kg	Ref.	
40 pcs	440x250x350	8	9576040001	1

## DUOBAG ÉLECTRICITÉ 53 PIÈCES



9000 5,5-7-8-10-11-12-13-14-16-17-18-19mm	9108 PZF1 - PZF2	9805 160mm	9608
9100 3,5x75-4x100-5,5x125-6,5x150mm	9100 3x55x08mm	9808 160mm	9871
9102 PH1 - PH2	9062 1,5-2-2,5-3-4-5-6-8-10mm	9802 200mm	6270 3 m
	9200	6480 240mm	6218
		9830	6217
			0416 18mm
			6247 18mm
			6248 10lames

	Dimensions mm	kg	Ref.	
53 pcs	450x200x365	7,23	9591053001	1

## TROLLEY BAG DÉPANNAGE 67 PIÈCES



9000 6-7-8-10-11-12-13-14-16-17-18-19mm	9102 PH1 - PH2	0861 210mm	7257
9100 3,5x75-5,5x125mm	9100 3,5mm	6247 18mm	6251 40cm
9101 6,5x150-8x150mm	9062 1,5-2-2,5-3-4-5-6-8-10mm	6218	0001 36 mm
9102 PH1 - PH2	9805 160mm	6369	0869 32mm
9108 PZ1 - PZ2	9804 180mm	6313 x5 - HSS O-300mm	7210 200mm
9100 4x100mm	9801 200mm	6312 x5300mm	7258 23-4-5mm
	6480 240mm	6270 3 m	6410
	9820 1960mm	6285 200mm	0900 200mm*8'
	9822 1960mm		0910 200mm*8'

	Dimensions mm	kg	Ref.	
67 pcs	450x250x390	11,63	9574067001	1

## DUOBAG MAINTENANCE 80 PIÈCES



9000 8-10-12-13-17-19mm	9062 1,5-2-2,5-3-4-5-6-8-10mm	9805 160mm	6270 3 m
9044 250mm	9288	0001 30mm	6369
9100 3,5x75-4x100-5,5x100-6,5x150mm	9460 30 embouts + 1 porte-embouts	6247 18mm	6312 x10
9102 PH1-PH2	6480 240mm	6248 x10	

	Dimensions mm	kg	Ref.	
80 pcs	450x200x365	7,060	9591080001	1



16



62



96



120



126



156



188



224



248



254



300



316



340



390



462



488



57



## MALLETTE ALUMINIUM 51 PIÈCES



9000 8-9-10-11-12-13-14-15-17-19 mm	9252 	9121 5,5x38x1	9102 PH1 - PH2	
9202 	9262 125 - 250 mm	9100 4x100x08 - 5,5x125x1 mm	9052 2-2,5-3-4-5-6-8mm	
9212 8-9-10-11-12-13-14-15-17-19-22-24 mm	9288 160mm	9101 6,5x150x1,2 mm	9804 180mm	
9281 16 - 21 mm	929D T10-T15-T20-T25	9122 PH2	6480 240mm	
			0001 30mm	
<b>51 pcs</b>	<b>Dim. mm</b> 410x320x80	<b>kg</b> 6,53	<b>Ref.</b> 9530051001	<b>📦</b> 1

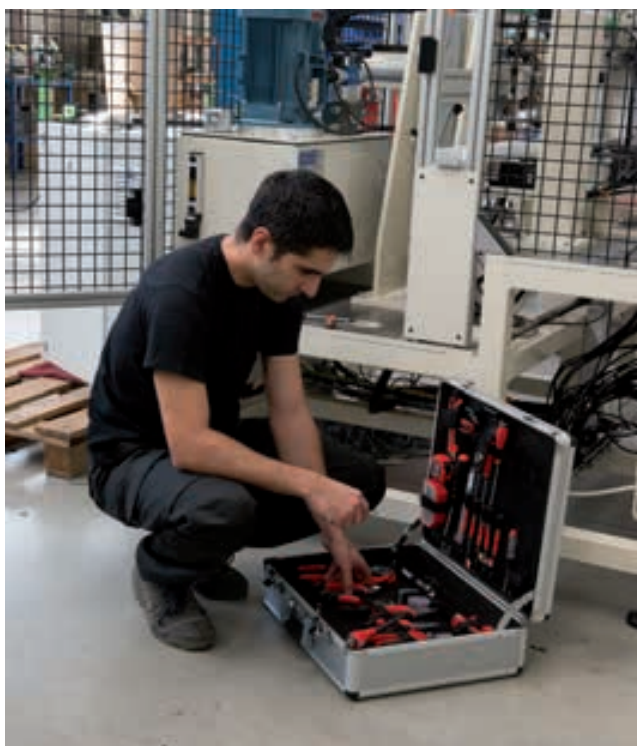

## VALISE ALUMINIUM 125 PIÈCES



9200 	9202 	9460 4x05-4,5x06-5,5x08-5,5x1,0-6,5x1,2mm	9062 1,5-2-2,5-3-4-5-6-8-10mm	
9210 4-5-5,5-6-7-8-9-10-11-12-13-14 mm	9215 10-11-12-13-14-15-16-17-18-19-20-21-22-24-27-30-32 mm	T7-T8-T9-T10-T15-T20-T25-T27-T30-T40	9804 180mm	
9216 3,2mm	9252 	H2-H2,5-H3-H4-H5-H5,5-H6	6480 240mm	
9250 	9272 255mm	PH0-PH1-PH2-PH3	0861 190mm	
9270 115mm	9262 125-250mm	PZ0-PZ1-PZ2-PZ3	6247 18mm	
9260 50-125 mm	9292 1/2" 8	9000 6-8-9-10-11-12-13-14-17-19-22 mm	6314	
929A porte embouts	9288 	9044 200mm	6312 x5 HSSCOO	
919Z 	9102 PH1 - PH2	9100 3,5x75 - 4x100mm	6270 2m	
	9160 23 mm	9101 5,5x100 - 6,5x150 - 8x150mm	6285 150mm	
	9162 PH00-PH0	9102 PH1 - PH2	6251 30cm	
		9160 23 mm	0001 30mm	
		9162 PH00-PH0	7258 4 - 5mm	
			7253 6 mm	
			7251 4mm	
<b>125 pcs</b>	<b>Dimensions mm</b> 490x400x155	<b>kg</b> 17	<b>Ref.</b> 9534125001	<b>📦</b> 1



## VALISE ALUMINIUM 128 PIÈCES



9200  1/4	9460 4xQ5- 4,5xQ6- 5,5xQ8- 5,5x1,0- 6,5x1,2mm	9000 8-9-10-11- 12-13-14- 16-17-19-22 mm	6480 240mm
9210 3,2-4-5-5,5- 6-7-8-9-10- 11-12-13-14 mm	PH0PH1- PH2-PH3	9044 200mm	9830
9250  1/4	PZ0-PZ1- PZ2-PZ3	9100 3,5x75- 4x100mm	6350 200mm
9270 115mm	T7-T8-T9- T10-T15- T20-T25- T27-T30-T40	9101 5,5x100 -6,5x150 mm	0861 190mm
9260 50-125mm	H2H2,5- H3-H4H5- H5,5H6	9102 PH1 - PH2	6247 18mm
9288  1/4	9202  1/2	9160 2 - 2,5 - 3 mm	9608 x30
929A  1/4	9212 10-11-12-13- 14-15-16- 17-18-19- 20-21-22- 24-27-30-32 mm	9162 PH0-PH0	6270 3 m
919Z  1/4	9252  1/2	9100 	6285 150mm
	9272 255mm	9062 1,5-2-2,5- 3-4-5-6-8- 10mm	6251 30cm
	9262 125-250mm	9805 160mm	9604 5LEDS
	9292 1/2->3/8	9804 180mm	0001 30mm
		9801 170mm	7258 45mm
		9808 160mm	7253 6mm
			7251 4mm
			0910 200mm



16



62



96



120



126



156



188



224



248



254



300



316



340



390



462



488

128 pcs	Dimensions mm	kg	Ref.	
	490x400x155	13,5	9534128001	1



# COMPOSITIONS

## VALISE TROLLEY ALUMINIUM 128 PIÈCES



## VALISE TROLLEY ABS 128 PIÈCES



9200  1/4	9252  1/2	9044 200 mm	6312 x5 HSS 000
9210 3,2-4-5-5,5-6-7-8-9-10-11-12-13-14 mm  1/4	9272 255 mm  1/2	9100 3,5x75 - 4x100 mm 	6270 3 m 
9250  1/4	9262 125-250 mm  1/2	9101 5,5x100 - 6,5x150 - 8x150 mm 	6285 150 mm 
9270 115 mm  1/4	9292 1/2->3/8  1/2	9102 PH1 - PH2 	7257 
9260 50-125 mm  1/4	9283  1/4	9160 2-3 mm 	6251 300 mm 
929A  1/4	9460 4x0,5-4,5x0,6-5,5x0,8-5,5x1,0-6,5x1,2 mm  1/4	9162 PH00 - PH0 	0001 30 mm 
919Z  1/4	PH0-PH1-PH2-PH3 PZ0-PZ1-PZ2-PZ3 T7-T8-T9-T10-T15-T20-T25-T27-T30-T40 H2-H2,5-H3-H4-H5-H5,5-H6	9100 	7258 4-5 mm 
9202  1/2	9215 10-11-12-13-14-15-16-17-18-19-20-21-22-24-27-30-32 mm  1/2	9062 1,5-2-2,5-3-4-5-6-8-10mm 	7253 6 mm 
	9000 6-8-9-10-11-12-13-14-17-19-22 mm 	9304 180 mm 	7251 4 mm 
		6480 240 mm 	0910 200 mm 
		0361 190 mm 	
		6247 18 mm 	
		6314 	

9200  1/4	9460 4x0,5-4,5x0,6-5,5x0,8-5,5x1,0-6,5x1,2 mm  1/4	9000 8-9-10-11-12-13-14-16-17-19-22 mm 	6480 240mm 
9210 3,2-4-5-5,5-6-7-8-9-10-11-12-13-14 mm  1/4	PH0-PH1-PH2-PH3 PZ0-PZ1-PZ2-PZ3 T7-T8-T9-T10-T15-T20-T25-T27-T30-T40 H2-H2,5-H3-H4-H5-H5,5-H6	9044 200 mm 	9330 
9250  1/4		9100 3,5x75 - 4x100 mm 	6350 200mm 
9270 115 mm  1/4		9101 5,5x100 - 6,5x150 mm 	0361 190mm 
9260 50-125 mm  1/4		9102 PH1 - PH2 	6247 18mm 
929A  1/4	9212 10-11-12-13-14-15-16-17-18-19-20-21-22-24-27-30-32 mm  1/2	9160 2 - 2,5 - 3 mm 	9603 x30 
919Z  1/4	9252  1/2	9162 PH00-PH0 	6270 3 m 
9202  1/2	9292 1/2 -> 3/8  1/2	9202 	6285 150mm 
		9212 10-11-12-13-14-15-16-17-18-19-20-21-22-24-27-30-32 mm  1/2	6251 30 cm 
		9252  1/2	9604 5 LEDS 
		9100 	0001 30mm 
		9062 1,5-2-2,5-3-4-5-6-8-10mm 	7258 4-5 mm 
		9272 255 mm  1/2	7253 6mm 
		9262 125-250 mm  1/2	7251 4mm 
		9305 160mm 	0910 200 mm 
		9304 180mm 	
		9301 170mm 	
		9303 160mm 	

	Dimensions mm	kg	Ref.	
128 pcs	490 x 400 x 155	12,7	9535128001	1

	Dimensions mm	kg	Ref.	
128 pcs	465x420x230	10	9538128001	1



## VALISE TROLLEY ABS ELECTRICITE 128 PIECES



9200  1/4	9460 4xQ5- 4.5xQ6- 5.5xQ8 5.5x1.0 6.5x1.2mm  1/4	9000 8-9-10-11- 12-13-14- 16-17-19-22 mm  9044 8'-200mm	9803 160mm 
9210 3,2-4.5-5.5- 6-7-8-9-10- 11-12-13-14 mm  1/4	PH0-PH1- PH2-PH3  PZ0-PZ1- PZ2-PZ3  T7-T8-T9- T10-T15- T20-T25- T27-T30-T40  H2-H2.5- H3-H4-H5- H5.5-H6  9202  1/2	9100 3.5x75- 4x100mm  9101 5.5x100 -6.5x150 mm  9102 PH1 - PH2  9160 2 - 2.5 - 3 mm  9162 PH00-PH0  9100  9062 1.5-2-2.5- 3-4-5-6-8- 10mm  9805 160mm  9804 180mm  9801 170mm 	6481 240mm  9830  6350 200mm  0861 190mm  6247 18mm  9608 x30  6270 3 m  6285 150mm  6251 30cm  9604 5LEDS  0001 30mm  7258 4-5mm  7253 6mm  7251 4mm  0910 200mm 
9250  1/4	9260 50-125mm  1/4	9283  1/4	929A  1/4
919Z  1/4	9272 255mm  1/2	9262 125-250mm  1/2	9292 1/2->3/8  1/2



16



62



96



120



126



156



188



224



248



254



300



316



340



390



462



488

128 pcs	Dimensions mm	kg	Ref.	1
	465x420x230	10	953812800A	





# 002



## CLIQUETS ET DOUILLES

**P.64**

| CARRÉ 1/4"



**P.78**

| CARRÉ 1/2"



**P.90**

| CARRÉ 3/4" ET 1"



**P.76**

| CARRÉ 3/8"



**P.86**

| CARRÉ 1/4"-1/2"



**P.94**

| SÉRIE IMPACT



**P.88**

| CLIQUET,  
DOUILLES TRAVERSANTS





# CLIQUET 1/4"



## CLIQUET ROND 1/4"

### SÉCURITÉ DU TRAVAIL

Verrouillage et déverrouillage rapides des douilles par bouton poussoir. Les douilles ou les accessoires ne se désolidarisent pas du cliquet.



### ACCESSIBILITÉ

L'angle de rotation de 5° (cliquet à 72 dents) assure une reprise très performante dans des espaces réduits. Les têtes des cliquets ont un encombrement réduit pour offrir l'accessibilité maximale.

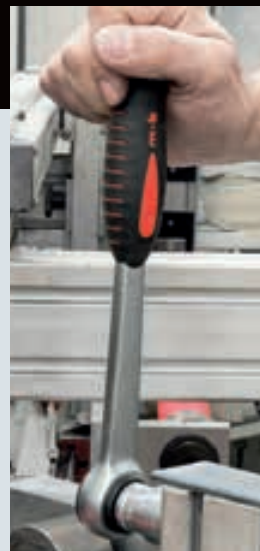
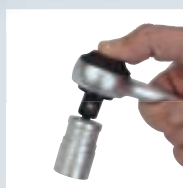
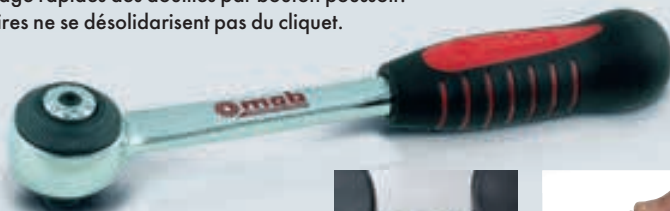

## CLIQUET MICRO 1/4"



NF ISO 3315/1174 - DIN 3122.



L mm	ØD mm	H mm	g	Ref.	☐
138	26	28	115	9200720001	1

## CLIQUET MICRO 1/4" SUR CARTE



72 dents.  
Inversion de sens.  
Bouton d'éjection.  
Manche bimatière.



L mm	ØD mm	H mm	g	Ref.	☐
138	26	28	115	9200721001	1



## CLIQUET POIRE 1/4"

### SÉCURITÉ

Lever de changement de sens intégré dans la tête = pas de risque d'inversion accidentelle. Déverrouillage des douilles par bouton poussoir.



- ERGONOMIE** : Changement de sens par le pouce.
- VISIBILITÉ** : Le sens est donné par la position du levier.
- ACCESSIBILITÉ** : Faible encombrement de la tête allongée.



## CLIQUET POIRE 1/4"



L mm	D mm	H mm	g	Ref.	☐
143	26	12,5	130	9200720101	1

## CLIQUET POIRE 1/4" SUR CARTE



72 dents.  
Lever d'inversion de sens.  
Bouton d'éjection.  
Manche bimatière.



L mm	ØD mm	H mm	g	Ref.	☐
143	26	12,5	130	9200721101	1



## CLIQUET TÊTE ROTATIVE 1/4"



### TÊTE ROTATIVE LIBREMENT ORIENTABLE :

- Utilisable comme un tournevis classique en position 0°.
- Utile lorsque la situation nécessite un dégagement.
- Utilisable en cliquet classique à 90°.



### ACCESSIBILITÉ

Cliquet de 100 dents.  
Angle de rotation de 3,6°.

### CARACTÉRISTIQUES

Inversion du sens de serrage sur toute la circonférence de la tête.  
Bouton éjection des douilles.  
Manche bimatière.

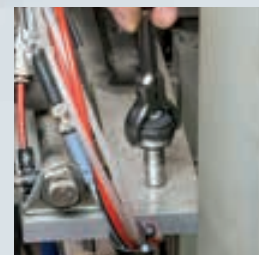
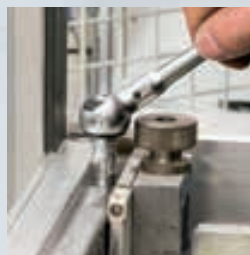

## CLIQUET TÊTE ROTATIVE 1/4"



L mm	D mm	H mm	g	Ref.	1
153	32	26	145	9200100001	1



## CLIQUET PORTE-DOUILLE / PORTE-EMBOUTS 1/4"

### 1 CLÉ 2 EN 1 :

- Un côté porte-embout
- Un côté cliquet 1/4", avec bouton éjecteur de douille et levier inverseur de sens



### FINESSE

- Passe partout en hauteur
- Bien moins encombrant que la combinaison cliquet + douille porte-embout

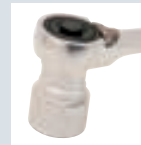
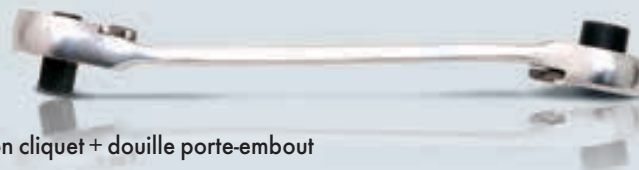

## CLIQUET PORTE-DOUILLE / PORTE-EMBOUTS 1/4"



L mm	A1 mm	A2 mm	B1 mm	B2 mm	g	Ref.	1
145	13	13	23	21	90	9205001001	1



16



62

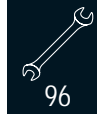

96



120

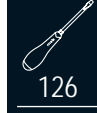

126



156



188

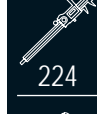

224

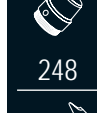

248



254



300



316



340



390

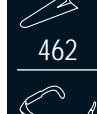

462

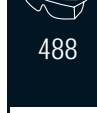

488



# DOUILLES 1/4"



## DOUILLES 1/4"

### RÉSISTANCE

La suppression des angles vifs des carrés augmente leur résistance.

### ERGONOMIE

Manipulation des douilles facile grâce à un épaulement extérieur prévu pour la prise. Pour trouver rapidement la douille souhaitée sa dimension est marquée sur tout le pourtour. Mob propose deux gammes de douilles :

- 6 pans pour serrages puissants.
- 12 pans pour la mise en place et la reprise facile dans les endroits encombrés.



### DOUILLE 6 PANS 1/4"

NF ISO 2725 - DIN 3124.

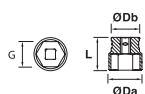

mm	ØDb mm	ØDa mm	L mm	g	Ref.	cube
3,2	11,85	6	25	9	9210C30001	5
4	11,85	6,8	25	9	9210040001	5
4,5	11,85	7,4	25	10	9210B40001	5
5	11,85	8	25	10	9210050001	5
5,5	11,85	8,7	25	10	9210A50001	5
6	11,85	9,3	25	11	9210060001	5
7	11,85	10,8	25	11	9210070001	5
8	11,85	11,5	25	11	9210080001	5
9	12	12,85	25	12	9210090001	5
10	12	14,35	25	17	9210100001	5
11	14	15,85	25	17	9210110001	5
12	14	16,85	25	18	9210120001	5
13	14	17,85	25	24	9210130001	5
14	14	19,7	25	28	9210140001	5

### DOUILLE 6 PANS 1/4" SUR CARTE

NF ISO 2725 - DIN 3124.



mm	ØDb mm	ØDa mm	L mm	g	Ref.	cube
7	10,8	11,85	25	11	9210071001	3
8	11,5	11,85	25	11	9210081001	3
10	14,35	12	25	17	9210101001	3
11	15,85	14	25	17	9210111001	3
12	16,85	14	25	18	9210121001	3
13	17,85	14	25	24	9210131001	3

### DOUILLE 6 PANS 1/4"

Pouces.

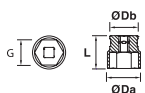

pouces	ØDb mm	ØDa mm	L mm	g	Ref.	cube
3/16	11,85	8	25	10	9210060101	5
7/32	11,85	8,7	25	10	9210070101	5
1/4	11,85	9,3	25	11	9210080101	5
9/32	11,85	10,8	25	11	9210090101	5
5/16	11,85	11,5	25	11	9210100101	5
11/32	12	12,85	25	12	9210110101	5
3/8	12	12,85	25	12	9210120101	5
7/16	14	15,85	25	15	9210140101	5
1/2	14	16,85	25	18	9210160101	5
9/16	14	19,7	25	28	9210180101	5

### RACKS DE DOUILLES 1/4" 12 PIÈCES

4 à 14 mm.



Contenu		L mm	g	Ref.	cube
4 - 5 - 5,5 - 6 - 7 - 8 - 9 - 10 - 11 - 12 - 13 - 14 mm	483	296	9481012001	1	

### DOUILLE 12 PANS 1/4"

NF ISO 2725 - DIN 3124.

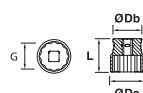

mm	ØDb mm	ØDa mm	L mm	g	Ref.	cube
3,2	11,85	6	25	9	9216C30001	5
4	11,85	6,8	25	9	9216040001	5
4,5	11,85	7,4	25	10	9216B40001	5
5,5	11,85	8,7	25	10	9216A50001	5
5	11,85	8	25	10	9216050001	5
6	11,85	9,3	25	11	9216060001	5
7	11,85	10,8	25	11	9216070001	5
8	11,85	11,5	25	11	9216080001	5
9	12	12,85	25	12	9216090001	5
10	12	14,35	25	17	9216100001	5
11	14	15,85	25	17	9216110001	5
12	14	16,85	25	18	9216120001	5
13	14	17,85	25	24	9216130001	5
14	14	19,7	25	28	9216140001	5

### DOUILLES 12 PANS 1/4"

Pouces.



pouces	ØDb mm	ØDa mm	L mm	g	Ref.	cube
7/32	11,85	8,7	25	10	9216070101	5
1/4	11,85	9,3	25	11	9216080101	5
9/32	11,85	10,8	25	11	9216090101	5
5/16	11,85	11,5	25	11	9216100101	5
3/8	12	12,85	25	12	9216120101	5
7/16	14	15,85	25	16	9216140101	5
1/2	14	16,85	25	18	9216160101	5
9/16	14	19,7	25	28	9216180101	5



## DOUILLE 6 PANS SÉRIE LONGUE 1/4"

NF ISO 2725 - DIN 3124.

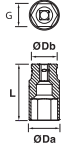

mm	ØDb mm	ØDa mm	L mm	g	Ref.	cube
3,2	11,85	6	50	15	9220C30001	5
4	11,85	6,8	50	16	9220040001	5
4,5	11,85	7,4	50	17	9220B40001	5
5	11,85	8	50	18	9220050001	5
5,5	11,85	8,7	50	18	9220A50001	5
6	11,85	9,3	50	18	9220060001	5
7	11,85	10,8	50	21	9220070001	5
8	11,85	11,5	50	21	9220080001	5
9	12	12,85	50	27	9220090001	5
10	12	14,35	50	33	9220100001	5
11	14	15,85	50	39	9220110001	5
12	14	16,85	50	43	9220120001	5
13	14	17,85	50	43	9220130001	5
14	14	19,7	50	54	9220140001	5

## RACKS DE DOUILLES LONGUES 1/4" 12 PIÈCES

4 à 14 mm.



Contenu	L mm	g	Ref.	cube
4 - 5 - 5,5 - 6 - 7 - 8 - 9 - 10 - 11 - 12 - 13 - 14 mm	483	470	9481012101	1

## AUGMENTATEUR CARRÉ 1/4" A 3/8"

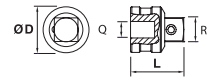

L mm	ØD mm	g	Ref.	cube
25	12	15	9290380001	1

## CARDAN UNIVERSEL 1/4"

NF ISO 3316 - DIN 3123.

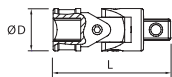

L mm	ØD mm	g	Ref.	cube
38	14	25	9250000001	1

## CARDAN UNIVERSEL 1/4" SUR CARTE

NF ISO 3316 - DIN 3123.

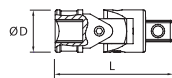

L mm	Ø mm	g	Ref.	cube
38	14	25	9250001001	1



## RALLONGE CLICK'N HOLD 1/4"



### SECURITE

La douille est verrouillée et ne se désolidarise pas de la rallonge.

### SIMPLICITE

Le déplacement de la bague déverrouille la douille, le geste est intuitif et simple.

## RALLONGE 1/4" CLICK'N HOLD



L mm	Ø1 mm	Ø2 mm	g	Ref.	cube
140	12	13	70	9265140001	1



16



62



96



120



126



156



188



224



248



254



300



316



340



390



462



488



# ACCESSOIRES 1/4"



## RALLONGE FLEXIBLE 1/4"

### ACCESSIBILITÉ

La rallonge flexible 1/4" est particulièrement indiquée dans les situations où l'accessibilité est réduite.



### RÉSISTANCE

Suffisamment rigide pour ne pas gêner et conçue pour un usage professionnel.

### RALLONGE FLEXIBLE 1/4"



L mm	ØD mm	g	Ref.	☐
150	12	64	9260000001	1

### RALLONGE 1/4"



NF ISO 3316 - DIN 3123.

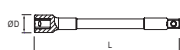

L mm	ØD mm	g	Ref.	☐
50	12	24	9260050001	1
75	12	35	9260070001	1
125	12	57	9260120001	1

### RALLONGE 1/4" SUR CARTE



NF ISO 3316 - DIN 3123.



L mm	Ø mm	g	Ref.	☐
50	12	24	9260051001	1
125	12	57	9260121001	1

### POIGNÉE COULISSANTE 1/4"



NF ISO 3315 - DIN 3122.

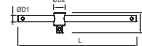

L mm	ØD1 mm	ØD2 mm	H mm	g	Ref.	☐
115	6,3	13,3	24	50	9270110001	1

### POIGNÉE COULISSANTE 1/4" SUR CARTE



NF ISO 3315 - DIN 3122.



L mm	H mm	g	Ref.	☐
115	24	50	9270111001	1



## SPIN POWER 1/4"

### ULTRA-RAPIDE

En phase de serrage/desserrage rapide : la clé en T tourne extrêmement vite, sans friction. La poignée aluminium rouge reste dans la main pendant que l'axe tourne.

### FINITION

Tige en Chrome Vanadium finition Nickel-Chrome. Poignée rotative en aluminium anodisé moleté. Bague de déverrouillage pour ajustage en 3 positions.



### SPIN POWER 1/4"



L mm	l mm	L1 mm	Ø1 mm	Ø2 mm	g	Ref.	☐
325	142	102	9	19	330	9278141001	1



## POIGNÉE ARTICULÉE MANCHÉ ACIER 1/4"



L mm	A	H mm	Ø1	g	Ref.	☐
150	13,8	20,5	14	115	9284150101	1

## POIGNÉE TOURNEVIS 1/4"



L mm	ØDb mm	ØDa mm	L1 mm	g	Ref.	☐
160	33	8	51	80	9283160001	1

## DOUILLE PORTE-EMBOUS 6 PANS 1/4"



S mm	L mm	g	Ref.	☐
1/4	25	12	929A000101	5

## DOUILLE PORTE-EMBOUS S 6 PANS 1/4" SUR CARTE



S mm	L mm	g	Ref.	☐
1/4	25	12	929A001101	3

## DOUILLE TOURNEVIS A FENTE 1/4"



ExD	L mm	g	Ref.	☐
0.6X4	32	10	929A060401	5

## DOUILLE TOURNEVIS DE TYPE PHILLIPS 1/4"



	L mm	g	Ref.	☐
PH1	32	10	929B010401	5
PH2	32	10	929B020401	5
PH3	32	10	929B030401	5

## DOUILLE TOURNEVIS DE TYPE POZIDRIV 1/4"



	L mm	g	Ref.	☐
PZ1	32	10	929C010401	5
PZ2	32	10	929C020401	5
PZ3	32	10	929C030401	5

## DOUILLE TOURNEVIS DE TYPE HEXAGONAL 1/4"

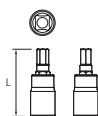

	L mm	g	Ref.	☐
H2.5	32	9	929E020401	5
H3	32	9	929E030401	5
H4	32	10	929E040401	5
H5	32	10	929E050401	5
H6	32	15	929E060401	5
H8	32	15	929E080401	5

## DOUILLE TOURNEVIS DE TYPE TORX 1/4"

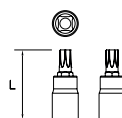

	L mm	g	Ref.	☐
T10	32	9	929D100401	5
T15	32	9	929D150401	5
T20	32	10	929D200401	5
T25	32	10	929D250401	5
T27	32	15	929D270401	5
T30	32	15	929D300401	5
T40	32	15	929D400401	5

## DOUILLE TOURNEVIS DE TYPE TAMPER TORX 1/4"

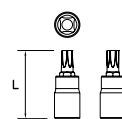

	L mm	g	Ref.	☐
TT10	32	15	929G100401	5
TT15	32	15	929G150401	5
TT20	32	20	929G200401	5
TT25	32	20	929G250401	5
TT30	32	15	929G300401	5

## MODULE DE DOUILLES ET CLIQUETS 1/4" 38 PIÈCES



- 10 douilles de 5.5 à 14 mm.
- 1 cliquet.
- 2 rallonges : 50 mm + 125 mm.
- 1 poignée coulissante.
- 1 cardan.
- 1 poignée emmanchée.
- 13 douilles tournevis.
- 9 clés mâles.



	Contenu	g	Ref.	☐
38 pcs	Ref. 9210 : 5.5-6-7-8-9-10-11-12-13-14 mm / Ref. 9200 / Ref. 9270 / Ref. 9250 / Ref. 9260 : 50-125 mm / Ref. 9283 / Ref. 929 : PH1-PH2-H4-H5-H6-PZ1-PZ2-0.6x4-1x5.5-T10-T15-T20-T25 / Ref. 9052	1135	9541038001	1





# COMPOSITIONS 1/4"

## MODULE DOUILLES ET CLIQUETS 1/4" 61 PIÈCES

- 13 douilles de 3,2 à 14 mm.
- 1 cliquet.
- 2 rallonges : 50 mm + 125 mm.
- 1 poignée coulissante.
- 1 cardan.
- Boîte de 30 embouts + 1 porte-embout
- 9 clés mâles.
- 1 tournevis porte-embouts.
- 1 douille porte-embouts.
- 1 embout porte-douille.



	Contenu	▲ g	Ref.	📦
61 pcs	Ref. 9210 : 3,2-4-5-5,5-6-7-8-9-10-11-12-13-14 mm / Ref. 9200 / Ref. 9270 / Ref. 9250 / Ref. 9260 : 50 mm + 125 mm / Ref. 9283 / Ref. 9460 / Ref. 919Z / Ref. 929 A / Ref. 9062	1200	9561061001	1

## MODULE MOUSSE DOUILLES 1/4" 59 PIÈCES

- 13 douilles : 3,2-4-5-5,5-6-7-8-9-10-11-12-13-14 mm.
- 1 poignée coulissante.
- 1 cliquet.
- 1 cardan.
- 2 rallonges 50 et 125.
- 9 clés mâles.
- 30 embouts de vissage sur rack.
- 1 poignée emmanchée.
- 1 douille porte embouts.



	Contenu	▲ g	Ref.	📦
59 pcs	Ref. 9210 : 3,2-4-5-5,5-6-7-8-9-10-11-12-13-14 mm / Ref. 9200 / Ref. 9270 / Ref. 9250 / Ref. 9260 : 50 mm + 125 mm / Ref. 9283 / Ref. 929 A / Ref. 9062 / Ref. 919x30	1080	9803059001	1



## BOX 31 - COFFRET VISSAGE 1/4 - 31 PIÈCES

### EXTRA-COMPACTÉ

- Les douilles et cliquets sont extra-courts afin d'obtenir une hauteur finale avec la clé extrêmement faible.

Douilles : hauteur 18 mm



Embouts : hauteur 18 mm



### COMPOSITION

- 1 clé 2 en 1 : cliquet et porte-embout,
- 23 embouts de vissage extra-courts,
- 7 douilles 1/4" extra-courtes.

### PRATIQUE

- Repérage facilité des outils grâce à la mousse de calage bicolore imprimée.
- Le coffret de petite taille se range d'autre part dans une caisse à outils.



## BOX 31 - COFFRET VISSAGE 1/4 31 PIÈCES

- 1 clé 2 en 1 : cliquet et porte-embout.
- 23 embouts de vissage extra-courts :
  - 2 Fentes : 4/5,5 - 5 Pozidriv : PZ0/PZ1/PZ2x2/PZ3.
  - 5 Phillips : PH0/PH1/PH2x2/PH3.
  - 7 Torx : T10/T15/T20/T25/T27/T30/T40.
  - 4 Hexagonaux : H3/H4/H5/H6.
- 7 douilles 1/4" extra-courtes : 5/7/8/10/12/13/14 mm.



Contenu	Dimensions mm	▲ g	Ref.	📦
31 pcs	125x90x30	285	9460031001	1





## XS BOX 1/4"

### COMPACTITÉ

- Idéal pour les espaces restreints
- Se range dans une caisse à outils
- 1 clé 2 en 1 : cliquet et porte-embout à cliquet.

### COFFRET 39 PIÈCES

- Coffret complet avec douilles 1/4" réf. 9210
- 30 embouts de vissage d'acier supérieur S2



### QUALITÉ DU COFFRET

- Charnière renforcée par une tige métallique.
- Facilité d'extraction des embouts.
- Repérage facilité des outils grâce à la mousse de calage imprimée bicolore : pour un repérage facilité des outils manquants.
- Fermeture à verrouillage latéral. En cas de chute, le coffret ne s'ouvre pas.

Embouts : hauteur 28 mm  
(au lieu de 58 mm  
avec un porte-embout et un cliquet classique)



Douilles : hauteur 35 mm  
(au lieu de 44 mm  
avec un cliquet classique)

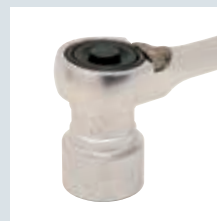

### COFFRET XS BOX 39 PIÈCES 1/4"

- 1 clé 2 en 1 : cliquet et porte-embout.
- 30 embouts de vissage :
  - 5 Fentes : 4/4,5/5,5/6,5/8
  - 6 Pozidriv : PZ0/PZ1x2/PZ2x2/PZ3
  - 4 Phillips : PH0/PH1/PH2/PH3
  - 7 Torx : T10/T15/T20/T25/T27/T30/T40
  - 8 Hexagonaux : H1,5/H2/H2,5/H3/H4/H5/H6/H8
- 1 rallonge 125 mm.
- 7 douilles 1/4" : 4/7/8/10/12/13/14 mm.



16



62



96



120

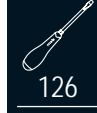

126



156



188

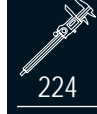

224



248

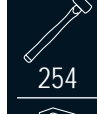

254



300



316

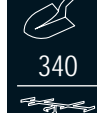

340



390

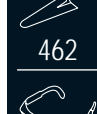

462

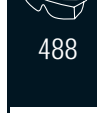

488

	Dimensions mm	g	Ref.	
39 pcs	175x110x40	560	9410390001	1



# COMPOSITIONS 1/4"



## COFFRET MAINTENANCE 11 EN 1

IDÉAL MAINTENANCE ITINÉRANTE

**1 SEULE CLÉ COUVRE 11 DIMENSIONS**

Mise en place rapide des bagues par simple clipsage.

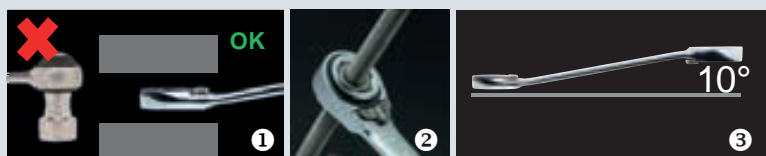

- ❶ **Tête plate** : Accessibilité favorisée grâce à la tête plate (là où un système cliquet/douilles ne passerait pas).
- ❷ **Fonction cliquet traversant** : la clé accède à des espaces réduits grâce à sa fonction traversante.
- ❸ **Inclinaison de la clé de 10°** : dégage la main de la zone de travail et favorise l'accès. Angle de reprise de 5° pour une reprise très performante dans les espaces restreints. Réversibilité pour changement rapide de sens. L'inverseur est intégré dans la clé : pas de risque d'inversion accidentelle.

### FINITION

Acier Chrome Vanadium forgé et trempé.  
Chromée et polie satinée.



### COFFRET MAINTENANCE 11 EN 1

- 1 clé polygonale à cliquet 14 et 19 mm.
- 9 bagues : 8-9-10-11-12-13-15-16-17 mm.



10 pcs	Dimensions mm 270x215x60	g 900	Ref. 9426100001	1
--------	-----------------------------	----------	--------------------	---



## COFFRET BOX 46 PIÈCES 1/4"

### COFFRET 46 PIÈCES

Coffret complet douilles 1/4" et vissage. Cliquet Premium 72 dents, 10 douilles, une poignée tournevis et 30 embouts de vissage. Rallonges dont une flexible exclusive.

### AMÉNAGEMENTS INTÉRIEURS

Mousse bicolore pour un repérage facile des manquants.  
Mousse haute densité, à cellule fermée, qui ne prend pas l'humidité.  
Les outils sont calés en douceur.



### COFFRET COMPACT

Coffret en PEHD Polyéthylène haute densité, léger et résistant.  
Compacité : 135x215x60mm.



## COFFRET BOX 1/4" 46 PIÈCES 6 PANS CLIQUET ROND

- 10 douilles 6 pans : 5,5/6/7/8/9/10/11/12/13/14mm.
- 1 cliquet Premium rond.
- 1 cardan.
- 1 rallonge 150 mm flexible.
- 1 rallonge 50 mm.
- 1 poignée tournevis.
- 1 douille porte-embouts.
- 30 embouts variés :
  - 5 Fentes : 4/4,5/5,5/6,5/8 mm
  - 4 Phillips : PH0/PH1/PH2/PH3
  - 6 Pozidriv : PZ0/2xPZ1/2xPZ2/PZ3
  - 7 Torx : T10/T15/T20/T25/T27/T30/T40
  - 8 Hexagonaux : H1,5/H2/H2,5/H3/H4/H5/H6/H8.



	Dimensions mm	g	Ref.	
46 pcs	135x215x60	990	9416046001	1



# COMPOSITIONS 1/4"

## COFFRET BOX 1/4" 16 PIÈCES 6 PANS CLIQUET POIRE

- 12 douilles 6 pans : 4/5/5,5/6/7/8/9/10/11/12/13/14 mm.
- 1 cliquet poire.
- 1 cardan.
- 2 rallonges : 50 et 125 mm.



	Dimensions mm	g	Ref.	
16 pcs	135x215x60	740	9415016001	1

## COFFRET BOX 1/4" 16 PIÈCES 12 PANS CLIQUET POIRE

- 12 douilles 12 pans : 4/5/5,5/6/7/8/9/10/11/12/13/14 mm.
- 1 cliquet poire.
- 1 cardan.
- 2 rallonges : 50 et 125 mm.



	Dimensions mm	g	Ref.	
16 pcs	135x215x60	1000	9415016101	1

## COFFRET BOX 1/4" 16 PIÈCES 6 PANS CLIQUET ROND

- 12 douilles 6 pans : 4/5/5,5/6/7/8/9/10/11/12/13/14 mm.
- 1 cliquet Premium rond.
- 1 cardan.
- 2 rallonges : 50 et 125 mm.



	Dimensions mm	g	Ref.	
16 pcs	135x215x60	1200	9415016201	1

## COFFRET BOX 1/4" 16 PIÈCES 12 PANS CLIQUET ROND

- 12 douilles 12 pans : 4/5/5,5/6/7/8/9/10/11/12/13/14 mm.
- 1 cliquet Premium rond.
- 1 cardan.
- 2 rallonges : 50 et 125 mm.



	Dimensions mm	g	Ref.	
16 pcs	135x215x60	1000	9415016301	1

## COFFRET MÉTALLIQUE 1/4" 29 PIÈCES 6 PANS CLIQUET ROND

- 11 douilles : 4-4,5-5-5,5-6-7-8-9-10-11-13 mm.
- 1 cliquet.
- 1 cardan.
- 1 poignée coulissante.
- 1 rallonge de 75 mm.
- 1 poignée tournevis.
- 1 douille porte-embouts.
- 12 embouts de vissage :
  - 2 fentes : 4-5 mm
  - 2 Phillips PH1-PH2
  - 2 Pozidriv PZ1-PZ2
  - 4 Hexagonaux H3-H4-H5-H6
  - 2 Torx T30-T40.



	Dimensions mm	g	Ref.	
29 pcs	240x115x40	985	000983401	1

## COFFRET PLASTIQUE 1/4" 31 PIÈCES 6 PANS CLIQUET POIRE

- 10 douilles : 4-5-6-7-8-9-10-11-12-13 mm.
- 1 cliquet poire.
- 1 cardan.
- 1 poignée coulissante.
- 3 rallonge 75, 125 et flexible 150 mm.
- 1 poignée bimatère.
- 14 douilles tournevis :
  - 2 fentes : 4-5,5 mm
  - 2 Phillips PH1-PH2
  - 4 Hexagonaux H3-H4-H5-H6
  - 6 Torx T10-T15-T20-T25-T30-T45.



	Dimensions mm	g	Ref.	
31 pcs	260x175x60	1115	9410310101	1

## COFFRET PLASTIQUE 1/4" 41 PIÈCES 6 PANS CLIQUET ROND

- 12 douilles 6 pans : 4-5-5,5-6-7-8-9-10-11-12-13-14 mm.
- 1 cliquet Premium rond.
- 1 cardan.
- 2 rallonges : 50, 125 mm.
- 1 poignée tournevis.
- 1 douille porte-embouts.
- 23 embouts variés :
  - 5 Fentes : 4-4,5-5,5-6,5-8 mm
  - 3 Phillips : PH1-PH2-PH3
  - 3 Pozidriv : PZ1-PZ2-PZ3
  - 7 TamperTorx : TT10-TT15-TT20-TT25-TT27-TT30-TT40
  - 5 Hexagonaux : H3-H4-H5-H6-H7.



	Dimensions mm	g	Ref.	
41 pcs	260x175x60	1020	9411041001	1



## COFFRET BOX CLIQUET TÊTE ROTATIVE 1/4"

### CLIQUET TÊTE ROTATIVE

Tête rotative librement orientable :

- Utilisable comme un tournevis classique en position 0°.
- Utile lorsque la situation nécessite un dégagement.
- Utilisable en cliquet classique à 90°.

### QUALITÉ

Denture fine du cliquet 100 dents angle de reprise 3,6°.  
Inversion du sens de serrage sur toute la circonférence de la tête. Bouton éjection des douilles.  
Manche bimatière.



### COFFRET BOX 1/4" 46 PIÈCES 6 PANS CLIQUET TÊTE ROTATIVE

- 12 douilles 6 pans : 4/5/5,5/6/7/8/9/10/11/12/13/14 mm.
- 1 cliquet rond tête rotative.
- 2 rallonges : 50-125 mm.
- 1 douille porte-embouts.
- 30 embouts de vissage :
  - 4 fentes : 3/4,5/5,5/8
  - 5 Phillips : PH1/PH2x2/PH3x2
  - 5 Pozidriv : PZ1/PZ2x2/PZ3x2
  - 10 Torx : T7/T8/T9/T10/T15/T20/T25/T27/T30/T40
  - 6 Hexagonaux : H3/H4/H5/H6/H8/H10.



16



62

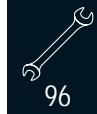

96



120

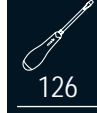

126



156



188

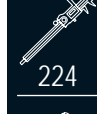

224

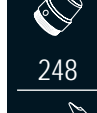

248



254



300



316



340



390

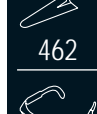

462

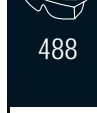

488

	Dimensions mm	g	Ref.	
46 pcs	135x215x60	900	9416046101	1



# CLIQUETS ET DOUILLES 3/8"



## BOX SPIN POWER 1/4"

### SPIN POWER

- Clé en T Spin Power ultra-rapide : la clé tourne extrêmement vite, sans friction et la poignée aluminium rouge reste dans la main pendant que l'axe tourne.



### FINITION

- Tige en Chrome Vanadium finition Nickel-Chrome.
- Poignée rotative en aluminium anodisé moleté.
- Bague de déverrouillage pour ajustage en 3 positions.



## BOX SPIN POWER 1/4" 33 PIÈCES 6 PANS CLIQUET ROND

- 11 douilles 6 pans : 4/5/6/7/8/9/10/11/12/13/14mm.
- 1 cliquet Premium rond.
- 1 cardan.
- 2 rallonges : 50 et 125 mm.
- 1 poignée spin power 310 mm.
- 1 poignée tournevis.
- 16 douilles tournevis :
  - 2 Fentes : 4/5,5
  - 2 Phillips : PH1/PH2
  - 2 Pozidriv : PZ1/PZ2
  - 6 Torx : T10/T15/T20/T25/T30/T40
  - 4 Hexagonaux : H3/H4/H5/H6



	Dimensions mm	g	Ref.	
33 pcs	405x225x60	1990	9436033101	1

## CLIQUETS ET DOUILLES 3/8"

### CLIQUET MEDIUM 3/8"



NF ISO 3315/1174 - DIN 3122.



L mm	ØD mm	H mm	g	Ref.	
192	31	34	218	9201720001	1

### DOUILLE 6 PANS 3/8"

NF ISO 2725 - DIN 3124.

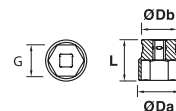

mm	ØDb mm	ØDa mm	L mm	g	Ref.	
7	16,9	10,7	30	24	9211070001	5
8	16,9	11,9	30	24	9211080001	5
9	16,9	13,2	30	25	9211090001	5
10	16,9	14,4	30	25	9211100001	5
11	16,9	15,7	30	25	9211110001	5
12	16,9	16,4	30	27	9211120001	5
13	17	17,8	30	28	9211130001	5
14	17,5	19,7	30	37	9211140001	5
15	18	21	30	42	9211150001	5
16	18	21,8	30	47	9211160001	5
17	19	23,8	30	57	9211170001	5
18	20	24,6	30	61	9211180001	5
19	20	25,7	30	62	9211190001	5
20	20	27,2	30	75	9211200001	5
21	22	28	30	78	9211210001	5
22	22	29,7	30	92	9211220001	5
23	22	31	30	93	9211230001	5
24	22	31,9	30	109	9211240001	5

### DOUILLE 12 PANS 3/8"

NF ISO 2725 - DIN 3124

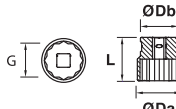

mm	ØDb mm	ØDa mm	L mm	g	Ref.	
7	16,9	10,7	30	24	9217070001	5
8	16,9	11,9	30	24	9217080001	5
9	16,9	13,2	30	25	9217090001	5
10	16,9	14,4	30	25	9217100001	5
11	16,9	15,7	30	25	9217110001	5
12	16,9	16,4	30	27	9217120001	5
13	17	17,8	30	28	9217130001	5
14	17,5	19,7	30	37	9217140001	5
15	18	21	30	42	9217150001	5
16	18	21,8	30	47	9217160001	5
17	19	23,8	30	57	9217170001	5
18	20	24,6	30	61	9217180001	5
19	20	25,7	30	62	9217190001	5
20	20	27,2	30	75	9217200001	5
21	22	28	30	78	9217210001	5
22	22	29,7	30	92	9217220001	5
23	22	31	30	93	9217230001	5
24	22	31,9	30	109	9217240001	5

# CLIQUETS ET DOUILLES 3/8"



## DOUILLE 12 PANS SÉRIE LONGUE 3/8"

NF ISO 2725 - DIN 3124.

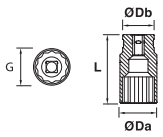

mm	ØDb mm	ØDa mm	L mm	g	Ref.	cube
7	16,9	10,7	63	48	9226070001	5
8	16,9	11,9	63	49	9226080001	5
9	16,9	13,2	63	52	9226090001	5
10	16,9	14,4	63	52	9226100001	5
11	16,9	15,7	63	60	9226110001	5
12	16,9	16,4	63	73	9226120001	5
13	17	17,8	63	74	9226130001	5
14	17,5	19,7	63	79	9226140001	5
15	18	21	63	84	9226150001	5
16	18	21,8	63	97	9226160001	5
17	19	23,8	63	123	9226170001	5
18	20	24,6	63	124	9226180001	5
19	20	25,7	63	138	9226190001	5
20	20	27,2	63	157	9226200001	5
21	22	28	63	164	9226210001	5
22	22	29,7	63	188	9226220001	5
23	22	31	63	194	9226230001	5
24	22	31,9	63	210	9226240001	5

## DOUILLE PORTE-EMBOUS 6 PANS 3/8"

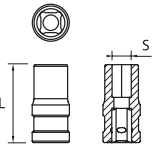

S mm	L mm	g	Ref.	cube
3/8	25	30	929A000201	5

## CARDAN UNIVERSEL 3/8"

NF ISO 3316 - DIN 3123.

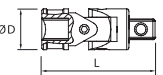

L mm	ØD mm	g	Ref.	cube
50	18	60	9251000001	1

## RÉDUCTEUR CARRÉ 3/8" A 1/4"

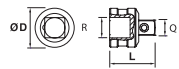

L mm	ØD mm	g	Ref.	cube
30	18	27	9291140001	1

## AUGMENTATEUR CARRÉ 3/8" A 1/2"

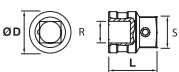

L mm	ØD mm	g	Ref.	cube
30	18	42	9291120001	1

## RALLONGE 3/8"

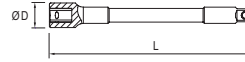

L mm	ØD mm	g	Ref.	cube
75	18	80	9261070001	1
125	18	115	9261120001	1
250	18	205	9261250001	1

## POIGNÉE ARTICULÉE 3/8"



L mm	H mm	g	Ref.	cube
250	28	330	9285250101	1

## POIGNÉE COULISSANTE 3/8"

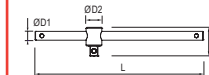

L mm	ØD1 mm	ØD2 mm	H mm	g	Ref.	cube
200	10,7	18,5	33	145	9271200001	1

## COFFRETS BOX 3/8" 23 PIÈCES CLIQUET ROND

- 18 douilles : 7-8-9-10-11-12-13-14-15-16-17-18-19-20-21-22-23-24 mm.
- 1 cliquet rond.
- 1 cardan.
- 1 poignée coulissante.
- 2 rallonges de 125 et 250 mm.



Pans	g	Ref.	cube
6	3200	9420010001	1
12	3200	9420020001	1



16



62



96



120



126



156



188



224



248

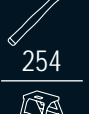

254



300



316



340



390



462



488



# CLIQUETS 1/2"



## CLIQUET ROND 1/2"

### ➤ SÉCURITÉ DU TRAVAIL

Verrouillage et déverrouillage rapides des douilles par bouton poussoir.

### ➤ ACCESSIBILITÉ

L'angle de rotation de 5° (cliquet à 72 dents).

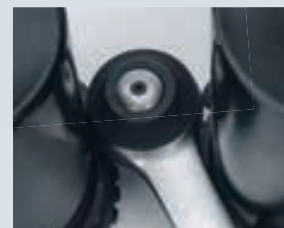

### ➤ MANCHE CONFORTABLE BIMATIÈRE

Étudié pour travailler dans toutes les positions.

- Le polypropylène pour plus de résistance.
- L'élastomère pour une bonne prise en main.

### ➤ LIAISON CORPS-MANCHE DU CLIQUET

Étudiée pour ne pas gêner la main lors de la prise.

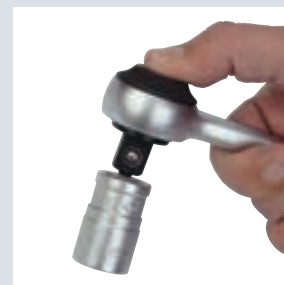
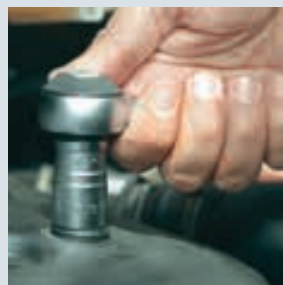

### CLIQUET ROND 1/2"

NF ISO 3315/1174 - DIN 3122.



L mm	ØD mm	H mm	g	Ref.	☐
243	38	45	490	9202720001	1

### CLIQUET POIRE 1/2"



L mm	D mm	H mm	g	Ref.	☐
263	40	20,5	595	9202720101	1

### CLIQUET 1/2" FEMELLE

Pour clé étagée.  
Carré d'entraînement 1/2" femelle.  
72 dents. Manche bimatière.



L mm	ØD mm	H mm	g	Ref.	☐
255	38	22	420	9027720001	1

### CLIQUET ROND 1/2" SUR CARTE

NF ISO 3315/1174 -  
DIN 3122.

L mm	ØD mm	H mm	g	Ref.	☐
243	38	45	490	9202721001	1

### CLIQUET POIRE 1/2" SUR CARTE

L mm	ØD mm	H mm	g	Ref.	☐
263	40	20,5	595	9202721101	1





# CLIQUETS ET DOUILLES 1/2"



## DOUILLES 1/2"



### RÉSISTANCE

La suppression des angles vifs des carrés augmente leur résistance.

### ERGONOMIE

La manipulation des douilles est rendue facile grâce à un épaulement extérieur prévu pour la prise. Pour trouver rapidement la douille souhaitée sa dimension est marquée sur tout le pourtour.

### 6 PANS - 12 PANS

2 gammes de douilles :  
 - 6 pans pour serrages puissants.  
 - 12 pans pour la mise en place et la reprise facile dans les endroits encombrés.



### DOUILLE 6 PANS 1/2"

NF ISO 2725 - DIN 3124.

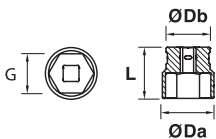

mm	ØDb mm	ØDa mm	L mm	g	Ref.	cube
8	22	12,8	38	44	9212080001	5
9	22	14,2	38	45	9212090001	5
10	22	15,3	38	49	9212100001	5
11	22	16,5	38	50	9212110001	5
12	22	17,8	38	51	9212120001	5
13	22	19	38	53	9212130001	5
14	22	20,3	38	55	9212140001	5
15	22	21,5	38	58	9212150001	5
16	22	23	38	62	9212160001	5
17	22	24	38	64	9212170001	5
18	22	25,3	38	68	9212180001	5
19	24	26,5	38	68	9212190001	5
20	24	28	38	78	9212200001	5
21	25	29	38	85	9212210001	5
22	25	30	40	90	9212220001	5
23	26	31	40	94	9212230001	5
24	26	33	40	102	9212240001	5
25	26	34	42	102	9212250001	5
26	28	35	45	110	9212260001	5
27	28	36	45	110	9212270001	5
28	28	38	45	112	9212280001	5
29	28	39	45	112	9212290001	5
30	28	40	45	116	9212300001	5
32	28	42	45	116	9212320001	5

### DOUILLE 6 PANS 1/2" SUR CARTE

NF ISO 2725 - DIN 3124.



mm	L mm	g	Ref.	cube
8	38	44	9212081001	3
9	38	45	9212091001	3
10	38	49	9212101001	3
11	38	50	9212111001	3
12	38	51	9212121001	3
13	38	53	9212131001	3
14	38	55	9212141001	3
15	38	58	9212151001	3
16	38	62	9212161001	3
17	38	64	9212171001	3
18	38	68	9212181001	3
19	38	68	9212191001	3
20	38	78	9212201001	3
21	38	85	9212211001	3
22	40	90	9212221001	3
23	40	94	9212231001	3
24	40	102	9212241001	3
26	45	110	9212261001	3
27	45	110	9212271001	3
30	45	116	9212301001	3
32	45	116	9212321001	3

### RACKS DE DOUILLES 1/2" 14 PIÈCES

8 à 24 mm.



mm	L mm	g	Ref.	cube
8-10-11-12-13-14-15-16-17-18-19-21-22-24	483	1200	9482014001	1



16



62



96



120



126



156



188



224



248



254



300



316



340



390



462



488



99



# DOUILLES 1/2"

## DOUILLE 6 PANS 1/2"

Pouces.

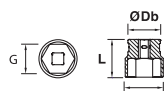

⌀ pouces	ØDb mm	ØDa mm	L mm	g	Ref.	⊠
3/8	22	14,2	38	45	9212120101	5
7/16	22	16,5	38	50	9212140101	5
1/2	22	19	38	53	9212160101	5
9/16	22	20,3	38	55	9212180101	5
5/8	22	23	38	62	9212200101	5
21/32	22	24	38	64	9212210101	5
11/16	22	25,3	38	68	9212220101	5
3/4	24	26,5	38	68	9212240101	5
13/16	24	28	38	78	9212260101	5
7/8	25	30	40	90	9212280101	5
15/16	26	33	40	102	9212300101	5
1	26	34	42	102	9212320101	5
1-1/16	28	36	45	110	9212020201	5
1-3/16	28	40	45	116	9212060201	5
1-1/4	28	42	45	116	9212080201	5

## DOUILLE 12 PANS 1/2"

NF ISO 2725 - DIN 3124.

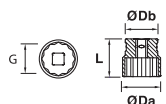

⌀ mm	ØDb mm	ØDa mm	L mm	g	Ref.	⊠
8	22	12,8	38	44	9215080001	5
9	22	14,2	38	45	9215090001	5
10	22	15,3	38	49	9215100001	5
11	22	16,5	38	50	9215110001	5
12	22	17,8	38	51	9215120001	5
13	22	19	38	53	9215130001	5
14	22	20,3	38	55	9215140001	5
15	22	21,5	38	58	9215150001	5
16	22	23	38	62	9215160001	5
17	22	24	38	64	9215170001	5
18	22	25,3	38	68	9215180001	5
19	24	26,5	38	68	9215190001	5
20	24	28	38	78	9215200001	5
21	25	29	38	85	9215210001	5
22	25	30	40	90	9215220001	5
23	26	31	40	94	9215230001	5
24	26	33	40	102	9215240001	5
25	26	34	42	102	9215250001	5
26	28	35	45	110	9215260001	5
27	28	36	45	110	9215270001	5
28	28	38	45	112	9215280001	5
29	28	39	45	112	9215290001	5
30	28	40	45	116	9215300001	5
32	28	42	45	116	9215320001	5

## DOUILLE 12 PANS 1/2" SUR CARTE

NF ISO 2725 - DIN 3124.



⌀ mm	L mm	g	Ref.	⊠
10	38	49	9215101001	3
13	38	53	9215131001	3
16	38	62	9215161001	3
17	38	64	9215171001	3
18	38	68	9215181001	3
19	38	68	9215191001	3
21	38	85	9215211001	3
24	40	102	9215241001	3
30	45	116	9215301001	3

## DOUILLE 12 PANS 1/2"

Pouces.

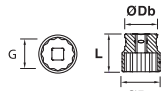

⌀ pouces	ØDb mm	ØDa mm	L mm	g	Ref.	⊠
3/4	24	26,5	38	68	9215240101	5

## DOUILLE 12 PANS SERIE LONGUE 1/2"

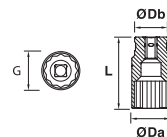

⌀ mm	ØDb mm	ØDa mm	L mm	g	Ref.	⊠
12	22	17,8	78	128	9227120001	5
13	22	19	78	130	9227130001	5
14	22	20,3	78	132	9227140001	5
15	22	21,5	78	132	9227150001	5
16	22	23	78	140	9227160001	5
17	22	24	78	150	9227170001	5
18	22	25,3	78	160	9227180001	5
19	24	26,5	78	160	9227190001	5
20	24	28	78	175	9227200001	5
21	25	29	78	180	9227210001	5
22	25	30	78	180	9227220001	5
23	26	31	78	190	9227230001	5
24	26	33	78	195	9227240001	5
25	26	34	78	195	9227250001	5
26	28	35	78	195	9227260001	5
27	28	36	78	200	9227270001	5
28	28	38	78	200	9227280001	5
29	28	39	78	200	9227290001	5
30	28	40	78	205	9227300001	5
32	28	42	78	205	9227320001	5

## RACK DE DOUILLES LONGUES 1/2" 14 PIECES

12 à 27 mm.



Contenu	l mm	g	Ref.	⊠
12-13-14-15-16-17-18-19-20-21-22-23-24-27 mm	445	2200	9430070001	1

## DOUILLE À BOUGIES 6 PANS 1/2"

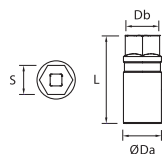

L mm	S mm	ØDb mm	ØDa mm	g	Ref.	⊠
67	16	19	22	110	9281160001	1
67	21	24	28	160	9281210001	1

## DOUILLE À BOUGIES 12 PANS 1/2"

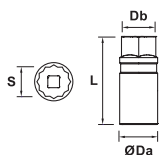

L mm	S mm	ØDb mm	ØDa mm	g	Ref.	⊠
67	16	19	22	110	9282160001	1
67	21	24	28	160	9282210001	1



## SPIN POWER 1/2"

### ULTRA-RAPIDE

En phase de serrage/desserrage rapide :  
 - la clé en T tourne extrêmement vite, sans friction.  
 - La poignée aluminium rouge reste dans la main pendant que l'axe tourne.

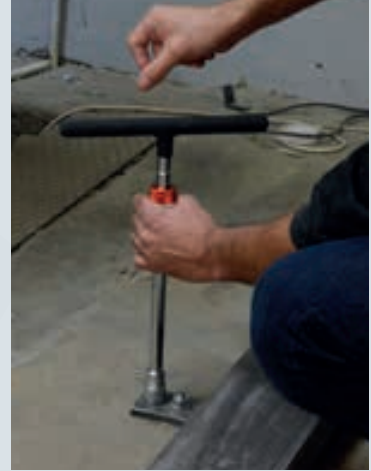

### ULTRA-PUISSANTE

En phase finale de serrage, la poignée permet de serrer avec puissance, à une ou même 2 mains.

## SPIN POWER 1/2"



L mm	l mm	L1 mm	Ø1 mm	Ø2 mm	Ø3 mm	g	Ref.	Q
330	243	102	16	31	12	1080	9278121001	1



## RALLONGE CLICK'N HOLD 1/2"

### SÉCURITÉ

La douille est verrouillée et ne se désolidarise pas de la rallonge.



### SIMPLICITÉ

Le déplacement de la bague déverrouille la douille, le geste est intuitif et simple.

## RALLONGE 1/2" CLICK'N HOLD



L mm	Ø1 mm	g	Ref.	Q
280	24	505	9267250001	1



16



62



96



120



126



156



188



224



248



254



300



316



340



390



462



488



# ACCESSOIRES 1/2"

## RALLONGE 1/2"



NF ISO 3316 - DIN 3123.



L mm	ØD mm	g	Ref.	☐
75	24	135	9262070001	1
125	24	225	9262120001	1
250	24	435	9262250001	1

## RALLONGE 1/2" SUR CARTE



NF ISO 3316 - DIN 3123.



L mm	Ø mm	g	Ref.	☐
125	24	225	9262121001	1
250	24	435	9262251001	1

## POIGNÉE COULISSANTE 1/2"



NF ISO 3316 - DIN 3123.



L mm	ØD1 mm	ØD2 mm	H mm	g	Ref.	☐
255	13,5	24	45	369	9272250001	1

## POIGNÉE COULISSANTE 1/2" SUR CARTE



NF ISO 3315 - DIN 3122.



L mm	H mm	g	Ref.	☐
255	45	369	9272251001	1

## POIGNÉE ARTICULÉE MANCHE ACIER 1/2"



L mm	A mm	Ø1 mm	g	Ref.	☐
250	37,5	20	525	9286250101	1
380	37,5	20	730	9286380101	1

## RÉDUCTEUR CARRÉ 1/2" À 3/8"



L mm	ØD mm	g	Ref.	☐
25	24	47	9292380001	1

## CARDAN UNIVERSEL 1/2"



NF ISO 3316 - DIN 3123.



L mm	ØD mm	g	Ref.	☐
70	25	139	9252000001	1

## CARDAN UNIVERSEL 1/2" SUR CARTE

NF ISO 3316 - DIN 3123.



L mm	ØD mm	g	Ref.	☐
70	25	139	9252001001	1

## DOUILLE TOURNEVIS A FENTE 1/2"

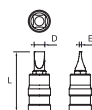

ExD	L mm	g	Ref.	☐
1,6x10	55	65	929A160201	5
2,0x12	55	75	929A200201	5
2,5x16	55	110	929A260201	5

## DOUILLE TOURNEVIS DE TYPE HEXAGONAL 1/2"

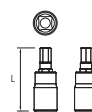

Type mm	L mm	g	Ref.	☐
H5	55	65	929E050201	5
H6	55	65	929E060201	5
H7	55	70	929E070201	5
H8	55	70	929E080201	5
H9	55	85	929E090201	5
H10	55	85	929E100201	5
H12	55	130	929E120201	5
H14	55	130	929E140201	5
H17	55	130	929E170201	5
H19	55	130	929E190201	5

## DOUILLE TOURNEVIS TYPE TORX 1/2"

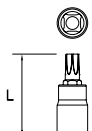

Type mm	L mm	g	Ref.	☐
T27	55	65	929D270201	5
T30	55	65	929D300201	5
T40	55	65	929D400201	5
T45	55	70	929D450201	5
T50	55	75	929D500201	5
T55	55	110	929D550201	5
T60	55	110	929D600201	5



## MODULE DE DOUILLES ET CLIQUETS 1/2" 23 PIÈCES

- 17 douilles de 10 à 32 mm.
- 1 cliquet.
- 2 rallonges : 125 mm + 250 mm.
- 1 poignée coulissante.
- 1 cardan.
- 1 adaptateur.



	Contenu	▲ g	Ref.	☐
23 pcs	Ref. 9212 : 10-11-12-13-14-15-16-17-18-19-20-21-22-24-27-30-32 mm / Ref. 9272 / Ref. 9202 / Ref. 9252 / Ref. 9262 : 125 mm + 250 mm / Ref. 9292	3125	9562023001	1

## MODULE DE DOUILLES ET CLIQUETS 1/2" 24 PIÈCES

- 18 douilles : 8 à 32 mm.
- 1 douille à bougie : 21 mm.
- 1 cliquet.
- 2 rallonges : 125 mm + 250 mm.
- 1 poignée coulissante.
- 1 cardan.



	Contenu	▲ g	Ref.	☐
24 pcs	Ref. 9212 : 8-9-10-11-12-13-14-15-16-17-18-19-21-22-24-27-30-32 mm / Ref. 9272 / Ref. 9202 / Ref. 9252 / Ref. 9281 : 21 mm / Ref. 9262 : 125 mm + 250 mm	3290	9542024001	1

## MODULE MOUSSE DOUILLES 1/2" 23 PIÈCES

- 18 douilles 6 pans : 8-9-10-11-12-13-14-15-16-17-18-19-21-22-24-27-30-32 mm.
- 1 poignée coulissante 255 mm.
- 1 cliquet.
- 1 cardan.
- 2 rallonges 125 et 250 mm.



	Contenu	▲ g	Ref.	☐
23 pcs	Ref. 9212 : 8-9-10-11-12-13-14-15-16-17-18-19-21-22-24-27-30-32 mm / Ref. 9272 / Ref. 9202 / Ref. 9252 / Ref. 9262 : 125 mm + 250 mm	3065	9804023001	1

## COFFRET MÉTALLIQUE 25 PIÈCES 6 PANS CLIQUET ROND

- 20 douilles 6 pans : 8-9-10-11-12-13-14-15-16-17-18-19-20-21-22-23-24-27-30-32 mm.
- 1 cliquet rond.
- 1 cardan.
- 2 rallonges 125-250 mm.
- 1 poignée coulissante.



	Dimensions mm	▲ g	Ref.	☐
25 pcs	450x180x50	4700	0000998001	1

## COFFRET PLASTIQUE 1/2" 27 PIÈCES, 6 PANS CLIQUET POIRE

- 17 douilles 6 pans : 8/9/10/11/12/13/14/16/17/18/19/21/22/24/27/30/32 mm.
- 3 douilles longues 13/17/19 mm.
- 1 cliquet poire.
- 1 cardan.
- 2 rallonges : 125 et 250 mm.
- 2 douilles bougies 16 et 21 mm.
- 1 poignée coulissante.



	Dimensions mm	▲ g	Ref.	☐
27 pcs	360x270x85	4420	9430270101	1

## COFFRET PLASTIQUE 1/2" 30 PIÈCES 6 PANS CLIQUET ROND - MOUSSE

- 22 douilles 6 pans : 8-9-10-11-12-13-14-15-16-17-18-19-21-22-23-24-26-27-28-29-30-32 mm.
- 3 douilles longues 13/17/19 mm.
- 1 cliquet rond.
- 1 cardan.
- 2 rallonges : 125 et 250 mm.
- 1 adaptateur 3/8.



	Dimensions mm	▲ g	Ref.	☐
30 pcs	360x270x85	4700	9431030001	1



16



62



96



120



126



156



188



224



248



254



300



316



340



390



462



488



# COMPOSITIONS 1/2"

## COFFRET BOX 1/2" 21 PIÈCES, 6 PANS, CLIQUET POIRE

- 17 douilles 6 pans : 8/10/11/12/13/14/15/16/17/18/19/21/22/24/27/30/32 mm.
- 1 cliquet poire.
- 1 cardan.
- 2 rallonges : 125 et 250 mm.



	Dimensions mm	g	Ref.	
21 pcs	405x225x60	3610	9435021001	1

## COFFRET BOX 1/2" 21 PIÈCES, 12 PANS, CLIQUET POIRE

- 17 douilles 12 pans : 8/10/11/12/13/14/15/16/17/18/19/21/22/24/27/30/32 mm.
- 1 cliquet poire.
- 1 cardan.
- 2 rallonges : 125 et 250 mm



	Dimensions mm	g	Ref.	
21 pcs	405x225x60	3720	9435021101	1

## COFFRET BOX 1/2" 21 PIÈCES, 6 PANS, CLIQUET ROND

- 17 douilles 6 pans : 8/10/11/12/13/14/15/16/17/18/19/21/22/24/27/30/32 mm.
- 1 cliquet rond.
- 1 cardan.
- 2 rallonges : 125 et 250 mm.



	Dimensions mm	g	Ref.	
21 pcs	405x225x60	3470	9435021201	1

## COFFRET BOX 1/2" 21 PIÈCES, 12 PANS, CLIQUET ROND

- 17 douilles 12 pans : 8/10/11/12/13/14/15/16/17/18/19/21/22/24/27/30/32 mm.
- 1 cliquet rond.
- 1 cardan.
- 2 rallonges : 125 et 250 mm.



	Dimensions mm	g	Ref.	
21 pcs	405x225x60	3580	9435021301	1



## COFFRET BOX 1/2" 28 PIÈCES, 6 PANS, CLIQUET ROND

### COFFRET 28 PIÈCES

21 douilles, un cliquet Premium 72 dents pour un serrage ultra-rapide, 1 poignée coulissante pour le serrage en force, 2 rallonges dont une click'n hold exclusive.

### AMÉNAGEMENTS INTÉRIEURS

Mousse bicolore pour un repérage facile des manquants. Mousse haute densité, à cellule fermée, qui ne prend pas l'humidité. Les outils sont calés en douceur.

### QUALITÉ

Coffret en PEHD Polyéthylène haute Densité, léger et résistant. Fermoirs métalliques très résistants.



## COFFRET BOX 1/2" 28 PIÈCES, 6 PANS, CLIQUET ROND, MOUSSE

- 21 douilles 6 pans : 8-9-10-11-12-13-14-15-16-17-18-19-20-21-22-23-24-27-28-30-32 mm.
- 1 cliquet rond.
- 1 cardan.
- 1 poignée coulissante.
- 1 rallonge 125 mm.
- 1 rallonge Click'hold 280 mm.
- 2 douilles bougies 16 et 21 mm.



- 16
- 62
- 96
- 120
- 126
- 156
- 188
- 224
- 248
- 254
- 300
- 316
- 340
- 390
- 462
- 488

28 pcs	Dimensions mm 405x225x60	g 4520	Ref. 9436028001	 1
--------	-----------------------------	-----------	--------------------	-------



# CLIQUETS ET DOUILLES 1/4" 1/2"

## CLIQUETS ET DOUILLES 1/4-1/2"

### MODULE DOUBLE DOUILLES ET CLIQUETS MIXTE 1/4" ET 1/2" 52 PIÈCES

Prend la place de

2 modules simples

- 1/4" : 12 douilles de 4 à 13 mm  
- cliquet - poignée - cardan - rallonges : 50-125 mm - poignée tournevis - 1 douille porte-embouts - 10 douilles tournevis
- 1/2" : 16 douilles de 10 à 32 mm - cliquet - poignée - cardan - rallonges : 125-250 mm - douilles bougies : 16-21 mm.



	Contenu	g	Ref.	
52 pcs	1/4" : Ref. 9200 / Ref. 9250 / Ref. 9260 : 50-125 mm / Ref. 9270 / Ref. 9283 / Ref. 9210 : 4-4,5-5-5,5-6-7-8-9-10-11-12-13 mm / Ref. 929A H3-H4-H5-H6-PZ1-PZ2-0,6x4-1x5,5-T30-T40 1/2" : Ref. 9202 / Ref. 9252 / Ref. 9262 : 125-250 mm / Ref. 9272 / Ref. 9282 : 16-21 mm / Ref. 9215 : 10-11-12-13-14-15-16-17-19-21-22-23-24-27-30-32 mm	3985	9543052001	1

### COFFRET PLASTIQUE TAMPER TORX 1/4"-1/2" 28 PIÈCES

1/4" :

- 7 douilles tournevis Tamper Torx : TT8, TT9, TT10, TT15, TT20, TT25, TT27.

- 7 douilles Torx femelle : E4, E5, E6, E7, E8, E10, E11

1/2" :

- 7 douilles tournevis Tamper Torx : TT30, TT40, TT45, TT50, TT55, TT60, TT70.

- 7 douilles Torx femelle : E11, E12, E14, E16, E18, E20, E24.



	Dimensions mm	g	Ref.	
28 pcs	260x175x60	1690	9028000000	1

### JEU DE DOUILLES TOURNEVIS TORX SUR RACK 1/4"-1/2" 13 PIÈCES

- 8 douilles tournevis Torx 1/4" : T8-T9-T10-T15-T20-T25-T27-T30.

- 5 douilles tournevis Torx 1/2" : T40-T45-T50-T55-T60.



Contenu	L mm	g	Ref.	
1/4 : T8-T9-T10-T15-T20-T25-T27-T30	445	700	9483013001	1
1/2 : T40-T45-T50-T55-T60				

### COFFRET MÉTALLIQUE MIXTE 1/4"-1/2" 52 PIÈCES CLIQUET ROND

- Carré 1/4" : 12 douilles 6 pans de 4 à 13 mm // 1 cliquet rond // 1 cardan // 1 poignée coulissante // 2 rallonges // 1 poignée emmanchée // 1 douilles porte-embouts // 10 embouts de vissage //

- Carré 1/2" : 16 douilles 12 pans de 10 à 32 mm // 2 douilles à bougie 16 et 21 mm // 1 cliquet // 1 cardan // 2 rallonges // 1 poignée coulissante



	g	Ref.	
52 pcs	6400	9413010001	1

### COFFRET BOX 1/4"-1/2" 33 PIÈCES 6 PANS CLIQUETS ROUNDS

- 1/4" : 10 douilles : 4/5/6/7/8/9/10/11/12/13 mm // 1 cliquet Premium rond // 1 cardan // 1 rallonge : 50 mm // 1 rallonge : 140 mm click'n hold.

- 1/2" : 15 douilles : 10/11/12/13/14/16/17/18/19/21/22/24/27/30/32 mm // 1 cliquet Premium rond // 1 cardan // 1 rallonge : 125 mm // 1 rallonge : 280 mm click'n hold.



	Dimensions mm	g	Ref.	
33 pcs	405x225x60	3910	9436033001	1

### COFFRET BOX 1/4"-1/2" 33 PIÈCES POUCE CLIQUETS POIRES

- 1/4" : 10 douilles : 3/16-7/32-1/4-9/32-5/16-11/32-3/8-7/16-1/2-9/16" // 1 cliquet poire // 1 cardan // 1 rallonge : 75 mm // 1 rallonge : 140 mm click'n hold

- 1/2" : 15 douilles : 3/8-7/16-1/2-9/16-5/8-21/32-11/16-3/4-13/16-7/8-15/16-1-1/16-1-3/16-1-1/4" // 1 cliquet poire // 1 cardan // 1 rallonge : 125 mm // 1 rallonge : 280 mm click'n hold.



	Dimensions mm	g	Ref.	
33 pcs	405x225x60	3900	9436033201	1



# CLIQUETS ET DOUILLES 1/4" 1/2"



## FUSION BOX CARGO DOUILLES 70 PIÈCES 1/4" 1/2"

### PRATIQUE

- Le coffret mixte 1/4"-1/2" Fusion Box est équipé de rails qui permettent d'accrocher un textile garni d'outils. Toutes les douilles sont bien rangées, complétées par la souplesse d'un sac textile détachable.
- Il permet aussi d'accrocher des Box complémentaires (vissage, clés, ...) afin de transporter plusieurs coffrets avec 1 seule main.



Exemple de composition avec textile

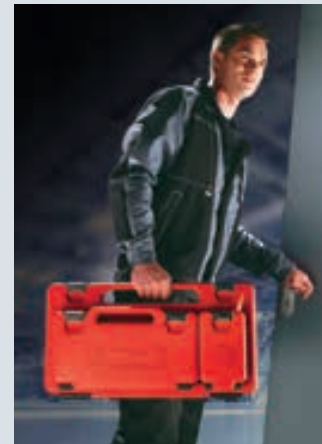

### QUALITÉ

- Coffret en PEHD Polyéthylène haute Densité, léger et résistant
- Fermoirs métalliques très résistants
- Mousse haute densité bicolore, idéale pour repérer les manquants
- Charnières triples renforcées par un jonc métal traversant.

## FUSION BOX CARGO DOUILLES - 1/4"-1/2" 70 PIÈCES 6 PANS CLIQUET ROND

- 1/4" : 10 douilles 6 pans : 4/5/6/7/8/9/10/11/12/13 mm // 1 cliquet rond // 1 cardan // 2 rallonges : 75 mm / 140 mm click'n hold // 1 poignée coulissante // 1 poignée tournevis // 1 douille porte-embouts // 30 embouts : 5 Fentes : 4/4,5/5,5/6,5/8 - 4 Phillips : PH0/PH1/PH2/PH3 - 4 Pozidriv : PZ0/PZ1/PZ2/PZ3 - 7 Torx : T10/T15/ T20/T25/T27/T30/T40 - 2 Tamper Torx TT10/TT20 - 8 Hexagonaux : H1,5/H2/H2,5/H3/H4/H5/H6/H8
- 1/2" : 16 douilles 6 pans : 10/11/12/13/14/15/16/17/18/19/21/22/24/27/30/32 mm // 1 cliquet rond // 1 cardan // 2 rallonges : 125 mm / 280 mm click'n hold // 1 poignée coulissante // 2 douilles à bougie : 16-21 mm



	Dim. mm	kg	Ref.	
70 pcs	600 x 330 x 90	6,2	9476070001	1



16



62



96



120



126



156



188



224



248



254



300



316



340

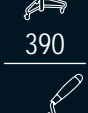

390



462

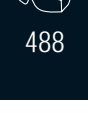

488



# CLIQUETS, DOUILLES TRAVERSANTES



## CLIQUET, DOUILLES TRAVERSANTES

### PRÉCISION - RAPIDITÉ - ERGONOMIE

Grâce à sa forme révolutionnaire, ce cliquet à tête traversante et les douilles associées permettent d'atteindre les endroits les plus inaccessibles : les tiges filetées traversent douilles et cliquet et ne gênent plus le serrage.

Plus rapide que des clés à pipe débouchées :

l'angle de reprise de 5° permet de serrer rapidement dans les espaces restreints.



### PRATIQUE

2 cliquets en 1.

Grâce à ses 2 adaptateurs, le cliquet s'adapte à toutes les douilles traditionnelles.



### CLIQUET À TÊTE TRAVERSANTE «MEDIUM»



L mm	ØD mm	H mm	g	Ref.	☐
205	32.5	11.5	250	9230010001	1

### DOUILLE TRAVERSANTE «MEDIUM»

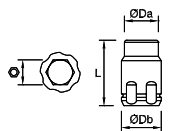

mm	L mm	ØDa mm	ØDb mm	g	Ref.	☐
10	32	15	19	30	9231100001	5
11	32	15	19	30	9231110001	5
12	32	16,5	19	30	9231120001	5
13	32	18	19	30	9231130001	5
14	32	19	19	30	9231140001	5
15	32	20	19	30	9231150001	5
16	32	21	19	30	9231160001	5
17	32	22,5	19	35	9231170001	5
18	32	24	19	35	9231180001	5
19	33	25	19	40	9231190001	5

### ADAPTATEUR DÉBOUCHANT «MEDIUM» VERS 1/4"

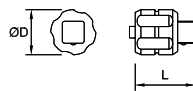

L mm	ØD mm	g	Ref.	☐
26	19	35	9233140001	1

### RALLONGE DÉBOUCHANTE «MEDIUM»

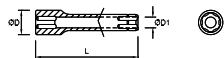

L mm	ØD mm	ØD1 mm	g	Ref.	☐
75	25	20	90	9232070001	1

### ADAPTATEUR DÉBOUCHANT «MEDIUM» VERS 3/8"

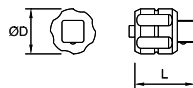

L mm	ØD mm	g	Ref.	☐
30	19	45	9233380001	1



## COFFRET DE DOUILLES TRAVERSANTES 14 PIÈCES «MEDIUM»

- 10 douilles : 10-11-12-13-14-15-16-17-18-19 mm.
- 1 cliquet traversant.
- 1 rallonge 75 mm.
- 2 adaptateurs.



	Dimensions mm	g	Ref.	
14 pcs	270x215x60	1150	9400010001	1

## COFFRET DE DOUILLES TRAVERSANTES 17 PIÈCES «MEDIUM»

- Coffret PEHD. Mousse bicolor.
- 13 douilles traversantes 10 à 22 mm.
- 1 cliquet traversant.
- 1 rallonge 75 mm.
- 2 adaptateurs.



	Dimensions mm	g	Ref.	
17 pcs	265x220x55	1350	9420017001	1

## COFFRET DE DOUILLES TRAVERSANTES «SMALL» 43 PIÈCES

- Coffret PEHD. Mousse bicolor.
- 13 douilles traversantes : 3.5 à 13 mm.
- 1 cliquet traversant.
- 1 rallonge 75 mm.
- 1 douille porte embout pour cliquet.
- 1 poignée tournevis.
- 1 douille porte embout.
- 24 embouts.
- 1 adaptateur.



	Dimensions mm	g	Ref.	
43 pcs	265x220x55	1050	9410043001	1

## COFFRET DE DOUILLES TRAVERSANTES 59 PIÈCES MIXTE «SMALL» ET «MEDIUM»

- Coffret PEHD. Mousse bicolor.
- Small :
- 13 douilles traversantes : 3.5 à 13 mm.
- 1 cliquet traversant.
- 1 rallonge 75 mm.
- 1 douille porte embout pour cliquet.
- 1 poignée tournevis.
- 1 douille porte embout.
- 24 embouts.
- Medium :
- 13 douilles traversantes 10 à 22 mm.
- 1 cliquet traversant.
- 1 rallonge 75 mm.
- 2 adaptateurs.



	Dimensions mm	g	Ref.	
59 pcs	350x265x75	2350	9470059001	1



16



62



96



120



126



156



188



224



248



254



300



316



340



390



462



488



# CLIQUETS ET DOUILLES 3/4"



## CLIQUETS ET DOUILLES 3/4"



### COMPACITÉ

- Accès aux environnements restreints facilité. : reprise de 9° (40 dents).
- Inverseur de sens encastré : changement contrôlé et d'une seule main.
- Manche démontable.

### DOUILLES

- Douilles montées avec un plongeur "lock pin" : permet de solidariser la douille de l'élément (rallonge, cliquet).

### RAYON DE PROTECTION DU CARRÉ

- Rayon de protection qui permet de répartir la charge et évite que la douille ne se casse.



### QUALITÉ

- Douilles 100% forgées tournées.
- Fabrication en acier chrome-vanadium, le meilleur matériau pour la fabrication de douilles.

### DURETÉS

- De 44 à 48 HRC
- Rapport dureté/longévité optimum.
- Couple 150% au dessus des normes. DIN 3120 et ISO 1174-1.

### FINITION

- 2 couches de nickel et 1 couche de chrome permet d'absorber les chocs et améliore la tenue de la finition.

### COFFRET

- Boîte métallique pour la robustesse.
- Une poignée frontale.
- Compartiments de rangement et une protection mousse à l'intérieur.



### CLIQUET POIRE 3/4"

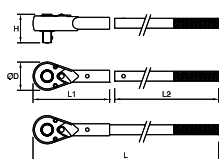

L mm	l1 mm	l2 mm	ØD mm	H mm	g	Ref.	☐
505	155	385	62,5	57	2800	9203400101	1

### DOUILLE 6 PANS 3/4"

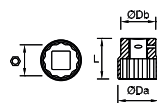

mm	L mm	ØDa mm	ØDb mm	g	Ref.	☐
22	50	32	36	215	9213220001	1
24	51	34	36	230	9213240001	1
27	52	38	36	250	9213270001	1
28	52	39	36	250	9213280001	1
29	52	40	36	275	9213290001	1
30	54	42	36	275	9213300001	1
32	56	44	36	295	9213320001	1
33	56	46	36	340	9213330001	1
36	58	50	38	410	9213360001	1
38	60	52	38	465	9213380001	1
41	64	56	40	545	9213410001	1
46	66	62	42	640	9213460001	1
50	70	68	42	770	9213500001	1
55	76	74	45	770	9213550001	1

# CLIQUETS ET DOUILLES 3/4"



## DOUILLE 6 PANS 3/4" SUR CARTE

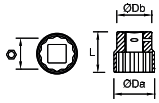

mm	L mm	ØDa mm	ØDb mm	g	Ref.	cube
22	50	32	36	215	9213221001	1
24	51	34	36	230	9213241001	1
27	52	38	36	250	9213271001	1
30	54	42	36	275	9213301001	1
32	56	44	36	295	9213321001	1
41	64	56	40	545	9213411001	1
46	66	62	42	640	9213461001	1
50	70	68	42	770	9213501001	1

## DOUILLE 12 PANS 3/4"

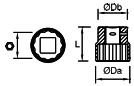

mm	L mm	ØDa mm	ØDb mm	g	Ref.	cube
22	51	33	36	215	9218220001	1
23	50	34	36	220	9218230001	1
24	52	34	36	230	9218240001	1
26	52	37	36	220	9218260001	1
27	52	38	36	250	9218270001	1
28	52	39	36	250	9218280001	1
29	53	42	38	275	9218290001	1
30	53	42	38	275	9218300001	1
32	56	44	38	295	9218320001	1
33	56	46	38	320	9218330001	1
35	58	48	42	380	9218350001	1
36	57	50	42	410	9218360001	1
38	60	53	45	465	9218380001	1
40	62	54	45	495	9218400001	1
41	64	56	45	545	9218410001	1
42	64	57	45	550	9218420001	1
46	68	62	47	640	9218460001	1
50	72	69	49	770	9218500001	1
55	72	69	49	770	9218550001	1

## CARDAN UNIVERSEL DOUILLE 3/4"

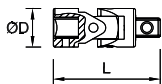

L mm	ØD mm	g	Ref.	cube
143	40	600	9253000001	1

## CARDAN UNIVERSEL DOUILLE 3/4" SUR CARTE

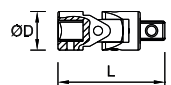

L mm	ØD mm	g	Ref.	cube
143	40	600	9253001001	1

## ADAPTATEURS 3/4" A 1/2"



3/4" => 1"	L mm	ØD mm	g	Ref.	cube
	54	34	175	9293100001	1

## ADAPTATEURS 3/4" A 1/2"



3/4" => 1/2"	L mm	ØD mm	g	Ref.	cube
	54	34	175	9293120001	1

## ADAPTATEURS 3/4" A 1/2"

3/4" => 1/2"

L mm	ØD mm	g	Ref.	cube
54	34	175	9293121001	1

## RALLONGE CARRÉ 3/4"



L mm	ØD mm	g	Ref.	cube
200	36	715	9263200001	1
400	36	1350	9263400001	1

## RALLONGE CARRÉ 3/4" SUR CARTE

L mm	ØD mm	g	Ref.	cube
200	36	715	9263201001	1
400	36	1350	9263401001	1

## POIGNÉE COULISSANTE 3/4"



L mm	ØD1 mm	ØD2 mm	H mm	g	Ref.	cube
455	20	37	60	1380	9273450001	1

## COFFRET MÉTALLIQUE 3/4" 16 PIÈCES

- 10 douilles : 22-24-27-30-32-36-38-41-46-50 mm.
- 1 cliquet 40 dents // 1 cardan.
- 1 poignée coulissante.
- 2 rallonges 200-400 mm.
- 1 adaptateur 3/4"-1/2".



	kg	Ref.	cube
6 pans	14	9440020001	1
12 pans	14	9440010001	1



16



62



96



120



126



156



188



224



248



254



300



316



340



390



462



488



91



# CLIQUETS ET DOUILLES 1''



## CLIQUETS ET DOUILLES 1''

### COMPACTITÉ

- Cliquet 36 dents soit une reprise de 10°, pour un accès aux environnements restreints facilité.
- Inverseur de sens encastré : changement contrôlé et d'une seule main.
- Manche démontable.

### DOUILLES

- Douilles montées avec un plongeur «lock pin» : permet de solidariser la douille de l'élément (rallonge, cliquet).

### RAYON DE PROTECTION DU CARRÉ

- Permet de répartir la charge et évite que la douille se casse.



### QUALITÉ

- Douilles 100% forgées tournées.
- Fabrication en acier chrome-vanadium, le meilleur matériau pour la fabrication de douilles.

### DURETÉS

- De 40 à 46 Hrc
- Rapport dureté/longévité optimum.
- Couple 150% au dessus des normes.
- DIN 3120 et ISO 1174-1.

### FINITION

- 2 couches de nickel et 1 couche de chrome permet d'absorber les chocs et améliore la tenue de la finition.

### COFFRET

- Boîte métallique pour la robustesse.
- Compartiments de rangement et une protection mousse à l'intérieur.



## CLIQUET POIRE 1''

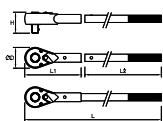

L mm	l 1 mm	l 2 mm	ØD mm	H mm	g	Ref.	1
675	205	538	70	67	5600	9204360101	1



## DOUILLE 6 PANS 1"

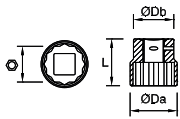

mm	L mm	ØDa mm	ØDb mm	g	Ref.	
36	65	53	45	480	9214360001	1
41	71	57	45	570	9214410001	1
46	76	65	50	805	9214460001	1
50	78	71	55	965	9214500001	1
55	81	77	57	1145	9214550001	1
60	84	82	57	1285	9214600001	1
65	89	89	57	1490	9214650001	1
70	94	94	68	1895	9214700001	1
75	98	100	68	2140	9214750001	1
80	104	105	68	2285	9214800001	1

## RALLONGE CARRÉ 1"



L mm	ØD mm	g	Ref.	
200	48	1300	9264200001	1
400	48	2300	9264400001	1

## DOUILLE 12 PANS 1"

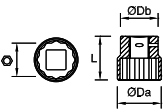

mm	L mm	ØDa mm	ØDb mm	g	Ref.	
36	65	53	45	480	9219360001	1
41	71	57	45	570	9219410001	1
46	76	65	50	805	9219460001	1
50	78	71	55	965	9219500001	1
55	81	77	57	1145	9219550001	1
60	84	82	57	1285	9219600001	1
65	89	89	57	1490	9219650001	1
70	94	94	68	1895	9219700001	1
75	98	100	68	2140	9219750001	1
80	104	105	68	2285	9219800001	1

## POIGNÉE COULISSANTE 1"

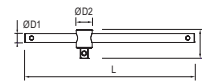

L mm	ØD1 mm	ØD2 mm	H mm	g	Ref.	
550	28	49	80	3300	9274550001	1

## CARDAN UNIVERSEL DOUILLE 1"

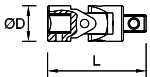

L mm	ØD mm	g	Ref.	
143	49	750	9254000001	1

## COFFRET MÉTALLIQUE 1" 17 PIÈCES, 6 PANS



- 10 douilles : 36-41-46-50-55-60-65-70-75-80 mm.
- 1 cliquet 36 dents.
- 1 cardan.
- 1 poignée coulissante.
- 2 rallonges 200-400 mm.
- 1 adaptateur 1"-3/4".



17 pcs	kg	Ref.	
	34	9450020001	1

## ADAPTATEUR 1" A 3/4"



L mm	ØD mm	g	Ref.	
68	48	425	9294340001	1

## COFFRET MÉTALLIQUE 1" 17 PIÈCES, 12 PANS



- 10 douilles : 36-41-46-50-55-60-65-70-75-80 mm.
- 1 cliquet 36 dents.
- 1 cardan.
- 1 poignée coulissante.
- 2 rallonges 200-400 mm.
- 1 adaptateur 1"-3/4".



17 pcs	kg	Ref.	
	34	9450010001	1

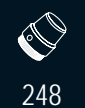



# SÉRIE IMPACT



## DOUILLES IMPACT



### QUALITÉ

Acier de qualité et traitement thermique garantissant une très grande résistance et une longue durée de vie.



Conçues pour résister aux contraintes des outils électroportatifs. Clés à chocs, visseuses...

Nota : la goupille et le joint ne sont pas livrés avec les produits.

### DOUILLES IMPACT 6 PANS 1/2"

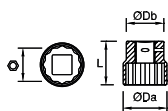

mm	ØDb mm	ØDa mm	L mm	g	Ref.	☐
8	25	15	38	65	9212080501	1
10	25	17	38	65	9212100501	1
11	25	18.5	38	70	9212110501	1
12	25	20	38	75	9212120501	1
13	25	21	38	75	9212130501	1
14	25	22.5	38	80	9212140501	1
15	30	23	38	110	9212150501	1
16	30	25	38	450	9212160501	1
17	30	26	38	120	9212170501	1
18	30	27.5	38	120	9212180501	1
19	30	28.5	38	120	9212190501	1
21	30	31	38	130	9212210501	1
22	30	32.5	38	140	9212220501	1
24	30	35	38	145	9212240501	1
27	30	38.5	45	200	9212270501	1
28	30	40	47	215	9212280501	1
30	30	42	50	255	9212300501	1
32	30	44	50	270	9212320501	1

### DOUILLES IMPACT LONGUES 6 PANS 1/2"



mm	ØDb mm	ØDa mm	L mm	g	Ref.	☐
10	25	17	80	135	9222100501	1
11	25	18.5	80	140	9222110501	1
13	25	21	80	160	9222130501	1
14	25	22.5	80	170	9222140501	1
16	30	25	80	230	9222160501	1
17	30	26	80	240	9222170501	1
18	30	27.5	80	255	9222180501	1
19	30	28.5	80	255	9222190501	1
21	30	31	80	285	9222210501	1
22	30	32.5	80	295	9222220501	1
24	30	35	80	360	9222240501	1
27	30	38.5	80	385	9222270501	1
28	30	40	80	420	9222280501	1
30	30	42	80	400	9222300501	1
32	30	44	80	470	9222320501	1

### CARDAN UNIVERSEL IMPACT 1/2"



L mm	ØD mm	g	Ref.	☐
58.5	30	170	9252000501	1

### ADAPTATEUR IMPACT 1/2" A 3/4"



ØF mm	ØM mm	L mm	ØD mm	g	Ref.	☐
1/2	3/4	45	25	115	9292340501	1

### RALLONGE IMPACT 1/2"



L mm	ØD mm	g	Ref.	☐
75	25	130	9262070501	1
125	25	195	9262120501	1
250	25	355	9262250501	1



## SPIN POWER IMPACT

### PRINCIPE

- La poignée équipée de roulement à billes reste dans la main pendant que la rallonge Impact tourne.
- En phase de serrage/desserrage rapide : la clé tourne extrêmement vite, sans friction.

### CARACTÉRISTIQUES

- Réglage 3 positions de la poignée
- Poignée rotative en aluminium anodisé moleté



Roulement à billes

### RALLONGE IMPACT SPIN POWER 1/2"



L mm	Ø1 mm	Ø2 mm	Ø3 mm	g	Ref.	☐
200	25	29	17	440	9262201501	1





## JONC+GOUPILLE DOUILLE 1/2" IMPACT

Pour verrouiller les douilles Impact en toute sécurité.



	g	Ref.	
8 -> 14 mm	5	9299140501	1
15 -> 32mm	5	9299990501	1

## COFFRET MÉTAL DE DOUILLES IMPACT 1/2" 10 PIÈCES

Joncs et goupilles fournis dans le coffret.



Contenu	g	Ref.	
10 pcs 10-11-12-13-14-17-19-21-22-24 mm	1290	9212010501	1

## COFFRET DE 3 DOUILLES IMPACT 1/2"

Douilles longues gainées



Contenu	g	Ref.	
3 pcs 17-19-21 mm	990	9430030501	1

## DOUILLES IMPACT 3/4"

### DOUILLES IMPACT 3/4"

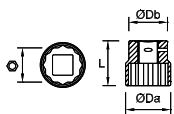

mm	ØDb mm	ØDa mm	L mm	g	Ref.	
19	44	32.5	51	335	9213190501	1
22	44	36	51	350	9213220501	1
23	44	37.5	51	355	9213230501	1
24	44	38.5	51	360	9213240501	1
27	44	42.5	53	375	9213270501	1
28	44	44	53	385	9213280501	1
29	44	45	53	390	9213290501	1
30	44	46	53	395	9213300501	1
32	44	48.5	57	445	9213320501	1
33	44	50	57	465	9213330501	1
34	44	51	57	465	9213340501	1
35	44	52.5	57	485	9213350501	1
36	44	53.5	57	490	9213360501	1
38	44	56	57	515	9213380501	1
41	44	60	58	565	9213410501	1
42	44	61	58	575	9213420501	1
46	44	66	62	665	9213460501	1

## DOUILLES IMPACT LONGUES 3/4"



mm	ØDb mm	ØDa mm	L mm	g	Ref.	
17	44	30	90	500	9223170501	1
19	44	32.5	90	515	9223190501	1
22	44	36	90	555	9223220501	1
24	44	38.5	90	570	9223240501	1
27	44	42.5	90	635	9223270501	1
30	44	46	90	685	9223300501	1
32	44	48.5	90	730	9223320501	1
36	44	53.5	90	840	9223360501	1
41	44	60	90	930	9223410501	1
46	44	66	90	1110	9223460501	1

## CARDAN UNIVERSEL IMPACT 3/4"



L mm	ØD mm	g	Ref.	
106	44	735	9253000501	1

## ADAPTATEUR IMPACT 3/4" A 1" / 3/4" A 1/2"



ØF->ØM mm	L mm	ØD mm	g	Ref.	
3/4" -> 1"	63	44	425	9293100501	1
3/4" -> 1/2"	58	44	335	9293120501	1

## ADAPTATEUR IMPACT 1" A 3/4"



ØF->ØM mm	L mm	ØD mm	g	Ref.	
1" -> 3/4"	66	54	630	9294340501	1

## RALLONGE IMPACT 3/4"



L mm	D mm	g	Ref.	
175	44	850	9263170501	1
250	44	1170	9263250501	1

## JONC+GOUPILLE DOUILLE 3/4" IMPACT

Pour verrouiller les douilles Impact en toute sécurité.



	g	Ref.	
19 -> 46 mm	5	9299460501	1



16



62



96



120



126



156



188



224



248



254



300



316



340



390



462



488





## CLÉS À OUVERTURE FIXE ET VARIABLE

**P.98**

| CLÉS MIXTES



**P.113**

| CLÉS À FRAPPER



**P.119**

| CLÉS DE MONTEUR



**P.114**

| CLÉS POLYGONALES



**P.119**

| CLÉS EN CROIX



**P.101**

| CLÉS À PIPE DÉBOUCHÉES



**P.115**

| CLÉS À TUYAUTER



**P.119**

| CLÉS À BÉQUILLE



**P.104**

| CLÉS À CLIQUET



**P.116**

| CLÉS À MOLETTE



**P.111**

| CLÉS À FOURCHES





# CLÉS MIXTES



## CLÉS MIXTES

### DURÉE DE VIE ❶

La longévité est obtenue par l'utilisation d'un acier forgé allié au chrome et vanadium. Son traitement thermique contrôlé lui confère la dureté pour résister aux sollicitations importantes. Les ouvertures des clés sont réalisées par brochage, technologie qui permet d'obtenir des cotes très précises avec un état de surface de qualité, ce qui évite d'abimer la clé ou l'écrou.

### PROFIL DE PROTECTION ❷

Le profil des têtes polygonales a été conçu spécialement pour ne pas mater les angles des écrous. Lors de l'effort, la pression ne s'exerce pas sur les angles mais sur les côtés de l'écrou.



Fabrication usine serrage Mob

### RÉSISTANCE ET PRÉCISION ❸

La résistance des clés Mob est largement supérieure aux spécifications des normes ISO. Résistance très supérieure à la norme.

### ERGONOMIE ❹

Confort d'utilisation : corps de la clé ergonomique non tranchant, permettant une bonne prise en main. Reliefs et marquages doux réalisés en forge à froid pour un confort tactile et un nettoyage facile.

### ACCESSIBILITÉ ❺

Angle de reprise de 30°. Inclinaison de 15° permettant une utilisation en milieux étroits.

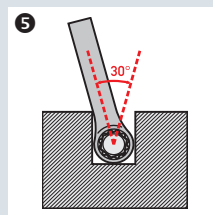
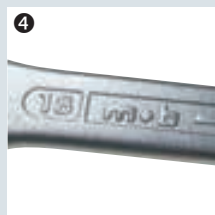
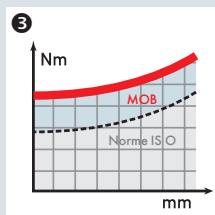



## CLÉS MIXTES

NF ISO 1711-3318-691 / DIN 899-3113.



mm	L mm	B1 mm	B2 mm	A1 mm	A2 mm	Lu mm	g	Ref.	📦
4	100	15	9,5	3,6	4,5	6,5	15	9000040001	5
5	100	15	9,5	3,6	4,5	6,9	15	9000050001	5
5,5	105	17	10	3,7	5	7,8	18	9000A50001	5
6	105	17	10	3,7	5	7,8	18	9000060001	5
7	110	19	11,5	3,7	5,5	8,7	20	9000070001	5
8	116	21	13	4	6,3	9,6	26	9000080001	5
9	125	23	14,5	4	6,5	10,5	29	9000090001	5
10	134	25	16	4,7	7	11,4	39	9000100001	5
11	143	27	17	4,7	7,5	12,2	43	9000110001	5
12	152	29	19	5,2	7,8	13,1	56	9000120001	5
13	161	31	20,5	5,2	8,5	14	70	9000130001	5
14	170	33	21,5	6	9	14,8	83	9000140001	5
15	179	35	22,5	6	9,2	15,7	90	9000150001	5
16	188	37	24	6,5	10	16,6	111	9000160001	5
17	197	39	25,5	6,5	10,5	17,5	128	9000170001	5
18	206	41	27	7,2	11	18,3	151	9000180001	5
19	215	44	28	7,5	11,5	20	161	9000190001	5
20	226	45	29,5	7,8	12	20,1	203	9000200001	5
21	237	47	30,5	7,8	12,5	21	217	9000210001	5
22	248	49	32,5	7,8	13	21,9	241	9000220001	5
23	259	51	33,5	7,8	13,5	22,7	256	9000230001	5
24	270	53	35,5	9	14	23,6	342	9000240001	5
25	281	55	36,5	9	14,5	24,5	361	9000250001	1
26	292	57	38	9	15	25,4	384	9000260001	1
27	303	59	39	10	15,5	26,3	415	9000270001	1
28	314	61	41	10	16	27,1	463	9000280001	1
29	325	63	42,5	10	16,5	28	487	9000290001	1
30	336	65	44,5	10	17	28,9	553	9000300001	1
32	347	69	46	10	18	30,7	585	9000320001	1
36	380	77	51,5	11	20	34	755	9000360001	1
41	436	87	58,5	11	22	38,2	955	9000410001	1

## CLÉS MIXTES - POUCES

NF ISO 1711-3318-691 / DIN 899-3113.

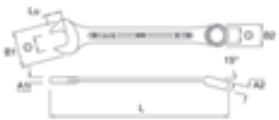

"	g	Ref.	📦
7/32	20	9000070101	5
1/4	26	9000080101	5
9/32	20	9000090101	5
5/16	25	9000100101	5
3/8	40	9000120101	5
7/16	45	9000140101	5
1/2	70	9000160101	5
9/16	80	9000180101	5
3/4	160	9000240101	5

## CLÉS MIXTES SUR CARTE

NF ISO 1711-3318-691 / DIN 899-3113.



mm	L mm	g	Ref.	📦
6	105	18	9000061001	3
7	110	20	9000071001	3
8	116	26	9000081001	3
9	125	29	9000091001	3
10	134	39	9000101001	3
11	143	43	9000111001	3
12	152	56	9000121001	3
13	161	70	9000131001	3
14	170	83	9000141001	3
15	179	90	9000151001	3
16	188	111	9000161001	3
17	197	128	9000171001	3
18	206	151	9000181001	3
19	215	161	9000191001	3
20	226	203	9000201001	3
21	237	217	9000211001	3
22	248	241	9000221001	3
23	259	256	9000231001	3
24	270	342	9000241001	3
25	281	361	9000251001	1
26	292	384	9000261001	1
27	303	415	9000271001	1
28	314	463	9000281001	1
29	325	487	9000291001	1
30	336	553	9000301001	1
32	347	585	9000321001	1

## CLÉS MIXTES LONGUES

Couple plus important.  
NF ISO 1711-3318-691 / DIN 899-3113.



mm	L mm	B1 mm	B2 mm	A1 mm	A2 mm	Lu mm	g	Ref.	📦
8	150	21	13	4	6,3	9,6	31	9001080001	5
9	165	23	14,5	4	6,5	10,5	36	9001090001	5
10	175	25	16	4,7	7	11,4	48	9001100001	5
11	185	27	17	4,7	7,5	12,2	52	9001110001	5
12	200	29	19	5,2	7,8	13,1	68	9001120001	5
13	210	31	20,5	5,2	8,5	14	85	9001130001	5
14	220	33	21,5	6	9	14,8	101	9001140001	5
15	230	35	22,5	6	9,2	15,7	107	9001150001	5
16	240	37	24	6,5	10	16,6	133	9001160001	5
17	255	39	25,5	6,5	10,5	17,5	156	9001170001	5
18	265	41	27	7,2	11	18,3	184	9001180001	5
19	275	44	28	7,5	11,5	20	195	9001190001	5
21	300	47	30,5	7,8	12,5	21	261	9001210001	5
22	310	49	32,5	7,8	13	21,9	287	9001220001	5
23	320	51	33,5	7,8	13,5	22,7	301	9001230001	5
24	335	53	35,5	9	14	23,6	407	9001240001	5
26	360	57	38	9	15	25,4	451	9001260001	1
27	370	59	39	10	15,5	26,3	482	9001270001	1
28	395	61	41	10	16	27,1	550	9001280001	1
30	425	65	44,5	10	17	28,9	660	9001300001	1
32	430	69	46	10	18	30,7	684	9001320001	1





# CLÉS MIXTES

3 Clés à ouverture fixe et variable

## JEUX DE CLÉS MIXTES BROCHABLES



	Contenu	g	Ref.	
6 pcs	7 - 8 - 10 - 13 - 17 - 19 mm	800	9000001201	1
8 pcs	8 - 10 - 11 - 13 - 16 - 17 - 18 - 19 mm	930	9000000301	1
8 pcs	8 - 10 - 11 - 13 - 17 - 19 - 22 - 24 mm	1265	9000000101	1
11 pcs	8 - 9 - 10 - 11 - 12 - 13 - 14 - 15 - 16 - 17 - 19 mm	1030	9000000201	1

## JEUX DE CLÉS MIXTES EN BOITE



	Contenu	g	Ref.	
8 pcs	8 - 9 - 10 - 11 - 13 - 14 - 17 - 19 mm	780	9000000401	1
9 pcs	8 - 9 - 10 - 11 - 12 - 13 - 14 - 17 - 19 mm	680	9000009001	1
9 pcs	8 - 10 - 11 - 12 - 13 - 16 - 17 - 18 - 19 mm	860	9000009101	1
9 pcs	7/32" - 1/4" - 9/32" - 5/16" - 3/8" - 7/16" - 1/2" - 9/16" - 3/4"	680	9000009201	1
10 pcs	8 - 10 - 11 - 12 - 13 - 14 - 15 - 17 - 19 - 22 mm	1150	9000000501	1
11 pcs	7 - 8 - 10 - 11 - 12 - 13 - 14 - 16 - 17 - 18 - 19 mm	965	9000011001	1
12 pcs	5,5 - 7 - 8 - 9 - 10 - 11 - 12 - 13 - 14 - 15 - 17 - 19 mm	970	9000000601	1
12 pcs	10 - 11 - 12 - 13 - 14 - 17 - 19 - 22 - 24 - 27 - 30 - 32 mm	2900	9000000701	1
12 pcs	7 - 8 - 10 - 11 - 12 - 13 - 16 - 17 - 18 - 19 - 22 - 24 mm	1600	9000000901	1
16 pcs	8 - 9 - 10 - 11 - 12 - 13 - 14 - 15 - 16 - 17 - 18 - 19 - 21 - 22 - 23 - 24 mm	2220	9000016001	1
18 pcs	6 - 7 - 8 - 9 - 10 - 11 - 12 - 13 - 14 - 15 - 16 - 17 - 18 - 19 - 21 - 22 - 23 - 24 mm	2260	9000018001	1
23 pcs	5,5 - 6 - 7 - 8 - 9 - 10 - 11 - 12 - 13 - 14 - 15 - 16 - 17 - 18 - 19 - 21 - 22 - 23 - 24 - 26 - 27 - 30 - 32 mm	4350	9000000801	1
24 pcs	6 - 7 - 8 - 9 - 10 - 11 - 12 - 13 - 14 - 15 - 16 - 17 - 18 - 19 - 21 - 22 - 23 - 24 - 26 - 27 - 28 - 29 - 30 - 32 mm	5215	9000024001	1

## MODULES DE CLÉS MIXTES



	Contenu	g	Ref.	
5 pcs	22 - 24 - 27 - 30 - 32 mm	2350	9544005001	1
9 pcs	8 - 10 - 11 - 12 - 13 - 14 - 17 - 19 - 22 mm	1050	9545009101	1
12 pcs	8 - 9 - 10 - 11 - 12 - 13 - 14 - 16 - 17 - 18 - 19 - 22 mm	1300	9547012001	1
16 pcs	6 - 7 - 8 - 9 - 10 - 11 - 12 - 13 - 14 - 15 - 16 - 17 - 18 - 19 - 22 - 24 mm	1470	9547016001	1

## MODULES MOUSSE CLÉS MIXTES



	Contenu	g	Ref.	
5 pcs	27 - 28 - 29 - 30 - 32 mm	2650	9801005001	1
12 pcs	6 - 7 - 8 - 9 - 10 - 11 - 13 - 14 - 17 - 18 - 19 - 21 mm	1135	9819012001	1
12 pcs	8 - 9 - 10 - 11 - 13 - 14 - 17 - 18 - 19 - 21 - 22 - 24 mm	1660	9819012101	1
17 pcs	6 - 7 - 8 - 9 - 10 - 11 - 12 - 13 - 14 - 15 - 16 - 17 - 18 - 19 - 21 - 22 - 24 mm	1960	9800017001	1

## TROUSSES DE CLÉS MIXTES



	Contenu	L x l mm	g	Ref.	
12 pcs	6 - 7 - 8 - 9 - 10 - 11 - 12 - 13 - 14 - 16 - 17 - 19 mm	455 x 310	935	9000012001	1

## COFFRET DE 15 CLÉS MIXTES

Coffret PEHD Polyéthylène  
Haute Densité.  
Mousse bicolore.



	Contenu	g	Ref.	
15 pcs	6 - 7 - 8 - 9 - 10 - 11 - 12 - 13 - 14 - 15 - 16 - 17 - 18 - 19 - 21 mm	2330	9480015001	1



## CLÉS À PIPE DÉBOUCHÉES

### QUALITÉ

- Les clés à pipe Mob présentent une qualité supérieure : monobloc, sans soudure, dans un acier CRV forgé, trempé.
- Le chanfrein d'entrée est plus apprécié et spécifique à Mob.



### EXCLUSIF

Chanfrein d'entrée qui favorise l'engagement de la clé.



### 6X6 PANS ET 6X12 PANS

Deux profils différents pour vous apporter l'outil adapté à chaque type de besoins.

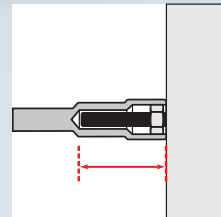

### ERGONOMIE

Une grande profondeur d'accueil des vis sur la partie de clé bouchée.

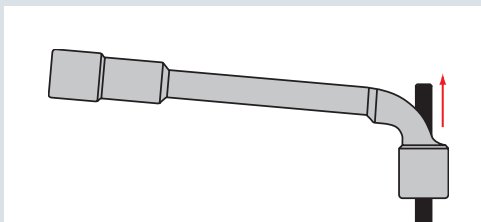

### PRATIQUE

Clé débouchée : le dépassement de la tige filetée ne gêne pas le serrage.

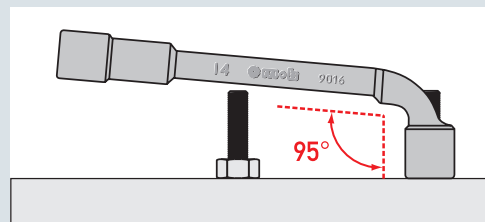

### ACCESSIBILITÉ

Angle de la clé à 95° pour favoriser le dégagement de la main du plan de serrage.



16



62



96



120



126



156



188



224



248



254



300



316



340



390



462



488



# CLÉS À PIPE DÉBOUCHÉES

3 Clés à ouverture fixe et variable

## CLÉS À PIPE DÉBOUCHÉES 6X6 PANS

NF ISO 2236.

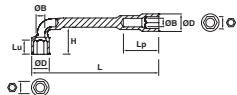

Ø mm	L mm	Lp mm	ØD mm	ØB mm	H mm	Lu mm	g	Ref.	📦
6	102	21	10	4,5	17	6	35	9015060001	5
7	106	22	10	4,5	17,5	7	55	9015070001	5
8	114	25	11,5	7	19,5	8	60	9015080001	5
9	122	26	12,5	7	20	9	75	9015090001	5
10	129	28	15	8	24	10	90	9015100001	5
11	136	30	16,5	8	26,5	11	115	9015110001	5
12	144	36	18	9	28	11	140	9015120001	5
13	152	38	19,5	9	30	12	145	9015130001	5
14	160	40	21	10,5	31,5	13	195	9015140001	5
15	169	42	22,5	10,5	34	14	210	9015150001	5
16	178	46	24	13	37	16	275	9015160001	5
17	187	48	25,5	13	39	17	315	9015170001	5
18	195	50	26,5	13	40	18	335	9015180001	5
19	204	51	28,5	15	41	19	435	9015190001	5
20	212	53	29,5	15	43	20	440	9015200001	5
21	221	55	30,5	15	46	21	445	9015210001	5
22	230	57	32	15	48	22	550	9015220001	5
23	240	64	33,5	18	50,5	23	625	9015230001	5
24	250	67	34,5	18	54	24	665	9015240001	5
25	260	69	36	20	56	25	715	9015250001	1
26	270	70	37	20	58,5	26	860	9015260001	1
27	280	73	38	22	58	27	970	9015270001	1
28	290	75	39,5	22	60	28	1000	9015280001	1
29	300	76	41	22	62	29	1100	9015290001	1
30	310	83	42	24	64	30	1220	9015300001	1
32	330	88	44,5	24	70	31	1430	9015320001	1
36	370	97	49,5	27	93	35	1875	9015360001	1

## CLÉS À PIPE DÉBOUCHÉES 6X6 PANS SUR CARTE

Côté débouché 6 pans - NF ISO 2236.



Ø mm	L mm	g	Ref.	📦
6	102	35	9015061001	3
7	106	55	9015071001	3
8	114	60	9015081001	3
9	122	75	9015091001	3
10	129	90	9015101001	3
11	136	115	9015111001	3
12	144	140	9015121001	3
13	152	145	9015131001	3
14	160	195	9015141001	3
15	169	210	9015151001	3
16	178	275	9015161001	3
17	187	315	9015171001	3
18	195	335	9015181001	3
19	204	435	9015191001	3
20	212	440	9015201001	3
21	221	445	9015211001	3
22	230	550	9015221001	3
23	240	625	9015231001	3
24	250	665	9015241001	3

## JEUX DE CLÉS À PIPE DÉBOUCHÉES 6X6 PANS BROCHABLES



	Contenu	g	Ref.	📦
6 pcs	7-8-10-13-17-19 mm	1850	9015000501	1
8 pcs	8-10-11-13-16-17-18-19 mm	2105	9015000101	1
10 pcs	7-8-9-10-11-13-16-17-18-19 mm	2285	9015000201	1

## JEUX DE CLÉS À PIPE DÉBOUCHÉES 6X6 PANS EN BOÎTE



	Contenu	g	Ref.	📦
10 pcs	8-10-11-12-13-14-16-17-18-19 mm	2490	9015010001	1
12 pcs	7-8-10-11-12-13-16-17-18-19-22-24 mm	3650	9015000401	1
16 pcs	8-9-10-11-12-13-14-15-16-17-18-19-21-22-23-24 mm	5230	9015016001	1

## MODULE DE CLÉS À PIPE 6X6 PANS



	Contenu	g	Ref.	📦
10 pcs	8-10-11-12-13-14-16-17-18-19 mm	2350	9565010001	1

## MODULE MOUSSE DE CLÉS À PIPE 6X6 PANS



	Contenu	g	Ref.	📦
13 pcs	7-8-9-10-11-12-13-14-15-16-17-18-19 mm	2560	9802013001	1

## TROUSSE DE CLÉS À PIPE 6X6 PANS



	Contenu	g	Ref.	📦
12 pcs	7-8-10-11-12-13-16-17-18-19-22-24 mm	3690	9015012001	1



# CLÉS À PIPE DÉBOUCHÉES



## CLÉS À PIPE DÉBOUCHÉES 6X12 PANS

NF ISO 2236.

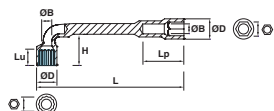

Ø mm	L mm	Lp mm	ØD mm	ØB mm	H mm	Lu mm	g	Ref.	☐
6	102	21	10	4,5	17	6	35	9016060001	5
7	106	22	10	4,5	17,5	7	55	9016070001	5
8	114	25	11,5	7	19,5	8	60	9016080001	5
9	122	26	12,5	7	20	9	75	9016090001	5
10	129	28	15	8	24	10	90	9016100001	5
11	136	30	16,5	8	26,5	11	115	9016110001	5
12	144	36	18	9	28	11	140	9016120001	5
13	152	38	19,5	9	30	12	145	9016130001	5
14	160	40	21	10,5	31,5	13	195	9016140001	5
15	169	42	22,5	10,5	34	14	210	9016150001	5
16	178	46	24	13	37	16	275	9016160001	5
17	187	48	25,5	13	39	17	315	9016170001	5
18	195	50	26,5	13	40	18	335	9016180001	5
19	204	51	28,5	15	41	19	435	9016190001	5
20	212	53	29,5	15	43	20	440	9016200001	5
21	221	55	30,5	15	46	21	445	9016210001	5
22	230	57	32	15	48	22	550	9016220001	5
23	240	64	33,5	18	50,5	23	625	9016230001	5
24	250	67	34,5	18	54	24	665	9016240001	5
25	260	69	36	20	56	25	715	9016250001	1
26	270	70	37	20	58,5	26	860	9016260001	1
27	280	73	38	22	58	27	970	9016270001	1
28	290	75	39,5	22	60	28	1000	9016280001	1
29	300	76	41	22	62	29	1100	9016290001	1
30	310	83	42	24	64	30	1220	9016300001	1
32	330	88	44,5	24	70	31	1430	9016320001	1

## CLÉS À PIPE DÉBOUCHÉES 6X12 PANS SUR CARTE

Côté débouché 12 pans - NF ISO 2236.



Ø mm	L mm	g	Ref.	☐
6	102	35	9016061001	3
7	106	55	9016071001	3
8	114	60	9016081001	3
9	122	75	9016091001	3
10	129	90	9016101001	3
11	136	115	9016111001	3
12	144	140	9016121001	3
13	152	145	9016131001	3
14	160	195	9016141001	3
15	169	210	9016151001	3
16	178	275	9016161001	3
17	187	315	9016171001	3
18	195	335	9016181001	3
19	204	435	9016191001	3
20	212	440	9016201001	3
21	221	445	9016211001	3
22	230	550	9016221001	3
23	240	625	9016231001	3
24	250	665	9016241001	3

## JEU DE CLÉS À PIPE DÉBOUCHÉES 6X12 PANS BROCHABLES

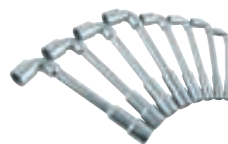

8 pcs	Contenu	g	Ref.	☐
	8 - 10 - 11 - 13 - 16 - 17 - 18 - 19 mm	2105	9016000101	1

## JEUX DE CLÉS À PIPE DÉBOUCHÉES 6X12 PANS EN BOÎTE



8 pcs	Contenu	g	Ref.	☐
	8 - 10 - 11 - 13 - 17 - 19 - 22 - 24 mm	2675	9016008001	1
10 pcs	8 - 10 - 11 - 12 - 13 - 14 - 16 - 17 - 18 - 19 mm	2490	9016010001	1
16 pcs	8 - 9 - 10 - 11 - 12 - 13 - 14 - 15 - 16 - 17 - 18 - 19 - 21 - 22 - 23 - 24 mm	5230	9016016001	1

## MODULE DE CLÉS À PIPE 6X12 PANS



10 pcs	Contenu	g	Ref.	☐
	8 - 10 - 11 - 12 - 13 - 14 - 16 - 17 - 18 - 19 mm	2300	9565010101	1



- 16
- 62
- 96
- 120
- 126
- 156
- 188
- 224
- 248
- 254
- 300
- 316
- 340
- 390
- 462
- 488



# CLÉS À CLIQUET



## CLÉS MIXTES À CLIQUET

### ➤ RÉSISTANCE

Acier au Chrome Vanadium, le meilleur acier pour les clés.

### ➤ PERFORMANCE

Réversibilité pour changement rapide de sens : productivité optimisée.  
Angle de reprise de 5° (6° pour les dimensions 8 et 9).

### ➤ SÉCURITÉ

Système à cliquet intégré : pas de risque d'inversion accidentelle.



### ➤ ACCESSIBILITÉ

Faible encombrement.  
Tête inclinée de 15°.

### ➤ CONFORT

Finition chromée et polie satinée.

### ➤ PRATIQUE

Reliefs et marquages à chaud "soft" (doux)  
pour un confort tactile et un nettoyage facile.

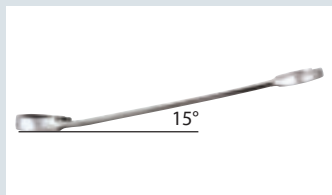



## CLÉS MIXTES À CLIQUET

ISO 1711-1.



Ø mm	L mm	B1 mm	B2 mm	A1 mm	A2 mm	Lu mm	g	Ref.	☐
8	140	18	18	5	7	9,5	35	9002080001	1
9	149	19	19	5	7	10,5	40	9002090001	1
10	157	23	21	6	8	11,5	55	9002100001	1
11	165	25	23	6,5	8	12,5	70	9002110001	1
12	172	27	24	7	9	13	80	9002120001	1
13	183	28	26	7	9	14	95	9002130001	1
14	190	29	28	7	9	15	110	9002140001	1
15	198	33	30	8	10	15,5	140	9002150001	1
16	206	33	30	8	10	16,5	160	9002160001	1
17	225	38	34	9	11	17,5	195	9002170001	1
18	235	39	35	9	11	18	210	9002180001	1
19	245	42	36	10	12	20	245	9002190001	1
21	290	47	39	10	13	22	355	9002210001	1
22	290	47	39	10	13	23	345	9002220001	1
24	333	52	45,5	10,5	14,5	25,5	530	9002240001	1

## CLÉS MIXTES À CLIQUET SUR CARTE

ISO 1711-1.



Ø mm	L mm	g	Ref.	☐
8	140	35	9002081001	1
10	157	55	9002101001	1
11	165	70	9002111001	1
12	172	80	9002121001	1
13	183	95	9002131001	1
17	225	195	9002171001	1
19	245	245	9002191001	1
22	290	345	9002221001	1
24	333	530	9002241001	1

## JEUX DE CLÉS MIXTES À CLIQUET BROCHABLES



	Contenu	g	Ref.	☐
6 pcs	8 - 10 - 12 - 13 - 17 - 19 mm	900	9002000301	1
10 pcs	8 - 10 - 11 - 12 - 13 - 15 - 16 - 17 - 18 - 19 mm	1365	9002000401	1

## JEUX DE CLÉS MIXTES À CLIQUET EN BOÎTE



	Contenu	g	Ref.	☐
7 pcs	8 - 10 - 12 - 13 - 14 - 17 - 19 mm	805	9002000501	1
9 pcs	8 - 10 - 11 - 12 - 13 - 16 - 17 - 18 - 19 mm	1150	9002000901	1
12 pcs	8 - 9 - 10 - 11 - 12 - 13 - 14 - 15 - 16 - 17 - 18 - 19 mm	1400	9002000601	1

## MODULE DE CLÉS MIXTES À CLIQUET

8 à 19 mm.



	Contenu	g	Ref.	☐
12 pcs	8-9-10-11-12-13-14-15-16-17-18-19mm	1625	9548012001	1

## MODULE MOUSSE 10 CLÉS MIXTES À CLIQUET

8 à 19 mm.



	Contenu	g	Ref.	☐
10 pcs	8-10-11-12-13-14-16-17-18-19 mm	1330	9811010001	1

## TROUSSE DE CLÉS MIXTES À CLIQUET



	Contenu	Lxl mm	g	Ref.	☐
12 pcs	8 - 10 - 12 - 13 - 14 - 16 - 17 - 18 - 19 - 21 - 22 - 24 mm	570x380	2035	9002012001	1

## BOX COFFRET DE 7 CLÉS MIXTES À CLIQUET



	Contenu	L mm	l mm	H mm	g	Ref.	☐
7 pcs	8-10-12-13-14-17-19 mm	270	215	60	1950	9002000101	1

## BOX COFFRET DE 12 CLÉS MIXTES À CLIQUET



	Contenu	L mm	l mm	H mm	g	Ref.	☐
12 pcs	8-9-10-11-12-13-14-15-16-17-18-19 mm	270	215	60	2415	9002000201	1



16



62



96



120



126



156



188



224



248



254



300



316



340



390



462



488



# CLÉS À CLIQUET

3 Clés à ouverture fixe et variable



## CLÉS À CLIQUET COURTES

### COMPACTITÉ

40% plus courte qu'une clé classique.

### PERFORMANCE

Tête traversante. Angle de reprise de 5°.  
Inversion du sens de rotation.

### SÉCURITÉ

Inverseur intégré dans la clé.

## Compact'

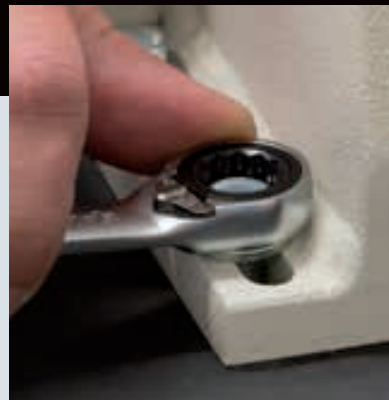

### QUALITÉ

Acier Chrome Vanadium trempé - 48 HRC +/- 2.  
Sablage fin + Finition chromée satinée :  
nettoyage facile et ergonomie d'utilisation (reflets atténués).

**-40%**

LE +

COMPACTE : Idéale dans les endroits difficiles d'accès



### CLÉS MIXTES À CLIQUET COURTES COMPACT'



Ø mm	L mm	B1 mm	B2 mm	A1 mm	A2 mm	Lu mm	g	Ref.	
7	93	16,5	17,5	5	7,5	8,5	30	9013070001	1
8	93	16,5	17,5	5	7,5	9,5	30	9013080001	1
9	95	20	21	6	7,5	10,5	45	9013090001	1
10	95	20	21	6	7,5	11,5	41	9013100001	1
11	105	25	23,5	6	9	12	60	9013110001	1
12	105	25	23,5	6	9	13	58	9013120001	1
13	106	26,5	25	6,5	9	14	65	9013130001	1
14	115	28	28	7	9	15	80	9013140001	1
15	122	33	30,5	8	10,5	15,5	110	9013150001	1
16	122	33	30,5	8	10,5	16,5	105	9013160001	1
17	125,5	35,5	32	8	10,5	17,5	125	9013170001	1
18	138	39,5	34	9	11	18	165	9013180001	1
19	138	39,5	34	9	11	20	160	9013190001	1

### JEU DE CLÉS MIXTES À CLIQUET COURTES COMPACT' BROCHABLE



	Contenu	L mm	l mm	H mm	g	Ref.	
7 pcs	8-10-12-13-14-17-19 mm	215	130	40	690	9013007001	1



## CLÉS À CLIQUET ARTICULÉES

### ACCESSIBILITÉ

Clé articulée à 180° ❶  
Adaptée aux endroits difficiles d'accès.  
Utilisation en aveugle possible.  
Dégage et sécurise la main face aux blessures.



### SÉCURITÉ

Cliquet intégré dans l'œil (angle de reprise à 5°, 6° pour les 8 et 9 mm) :  
reprise rapide, idéal pour l'approche, le desserrage rapide.

### QUALITÉ

Acier Chrome Vanadium trempé - 48 HRC +/- 2.  
Sablage fin + Finition chromée satinée :  
nettoyage facile et ergonomie d'utilisation (reflets atténués).



### CLÉS MIXTES À CLIQUET ARTICULÉES

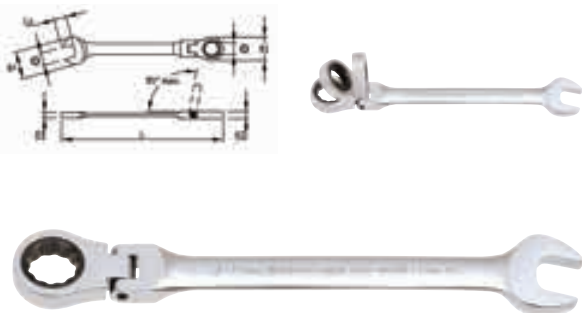

mm	L mm	B1 mm	B2 mm	A1 mm	A2 mm	Lu mm	g	Ref.	
8	140	16,5	16	5	6,5	9,5	40	9008080001	1
10	158	21	19	5,5	7,5	11,5	60	9008100001	1
13	178	27	23,5	6,5	8,5	14	100	9008130001	1
17	225	35,5	30,5	8	10,5	17,5	190	9008170001	1
19	248	39,5	32,5	9	11	20	260	9008190001	1

### JEU DE 5 CLÉS À CLIQUET ARTICULÉES EN COFFRET



	Contenu	L mm	L mm	H mm	g	Ref.	
5 pcs	8 - 10 - 13 - 17 - 19 mm	315	125	63	860	9008005001	1



16



62



96



120



126



156



188



224



248



254



300



316



340



390



462



488



# CLÉS À CLIQUET

3 Clés à ouverture fixe et variable



## CLÉS À CLIQUET 4X4



### PRATIQUE

4 dimensions couvertes par une seule clé.  
En particulier la clé 10-13-17-19 mm  
idéale en doublure de clé ou en dépannage.



1 CLÉ  
4 DIMENSIONS

LES 4 DIMENSIONS  
LES PLUS UTILISÉES  
EN 1 SEULE CLÉ



### COMPACITÉ

4 clés couvrent 16 dimensions.  
Idéal pour la maintenance itinérante ou les doublures de clés.

### PERFORMANCE

L'angle de reprise de 5° assure une reprise très performante dans les espaces réduits : rapidité et accessibilité.

### RÉVERSIBILITÉ

Pour changement rapide de sens : productivité optimisée.

### SÉCURITÉ

Inverseur intégré dans la clé : pas de risque d'inversion accidentelle.

### FINITION

Acier Chrome Vanadium forgé trempé  
Chromée et polie satinée.



## CLÉS À CLIQUET 4X4



mm	L mm	B1 mm	B2 mm	A1 mm	A2 mm	g	Ref.	
8-10-12-13	160	21	26	7,5	8,5	80	9003080001	1
9-11-14-15	180	23,5	30	8	10	115	9003090001	1
10-13-17-19	180	26	36	8,5	11,2	180	9003100001	1
16-17-18-19	230	32,5	35	10,5	11	215	9003160001	1
20-21-22-24	290	42,5	49	13	14,5	495	9003200001	1

## CLÉ À CLIQUET 4X4 SUR CARTE

1 clé, 4 dimensions.



mm	L mm	g	Ref.	
10-13-17-19	180	180	9003101001	1

## JEU DE 2 CLÉS À CLIQUET 4X4



	Contenu	g	Ref.	
2 pcs	8-10-12-13 + 16-17-18-19 mm	315	9003001001	1

## MODULE DE 4 CLÉS À CLIQUET 4X4



	Contenu	g	Ref.	
4 pcs	8-10-12-13 + 9-11-14-15 + 16-17-18-19 + 20-21-22-24 mm	900	9566004001	1

## BOX COFFRET DE 4 CLÉS À CLIQUET 4X4



	Contenu	Dimensions mm	g	Ref.	
4 pcs	8-10-12-13 + 9-11-14-15 + 16-17-18-19 + 20-21-22-24 mm	270x215x60	1785	9003000101	1



## CLÉS À CLIQUET 2X2

### 2 CLÉS EN 1

Rangement et transport facilités pour les itinérants.

### ACIER : Chrome Vanadium trempé 48 HRC +/-2

Sablage fin et finition chromée satinée brillant.



### CLÉ EXTRA-PLATE - TÊTE TRAVERSANTE :

Cliquet intégré dans l'œil.

Angle de reprise de 5°.

(6° pour les 8 et 9 mm).

## CLÉS À CLIQUET 2X2



mm	L mm	B1 mm	B2 mm	A1 mm	A2 mm	g	Ref.	
8x9	130	16	17,5	6,5	7	40	9004080001	1
10x11	150	19	20,5	7,5	7,5	55	9004100001	1
12x13	170	21,5	23,5	8	8,5	80	9004120001	1
16x18	210	28,5	31,5	10	10,5	160	9004160001	1
17x19	230	30,5	34	10	11	190	9004170001	1
22x24	290	39	45,5	13	14,5	550	9004220001	1

## JEU DE 4 CLÉS À CLIQUET 2X2 BROCHABLE



	Contenu	L mm	l mm	H mm	g	Ref.	
4 pcs	10x11 - 12x13 - 16x18 - 17x19 mm	315	125	63	680	9004004001	1

## JEU DE CLÉS À CLIQUET 2X2 EN BOÎTE



	Contenu	L mm	l mm	H mm	g	Ref.	
6 pcs	8x9 - 10x11 - 12x13 - 16x18 - 17x19 - 22x24 mm	300	95	30	1020	9004006001	1



16



62



96



120



126



156



188



224



248



254



300



316



340



390



462



488



# CLÉS À CLIQUET



## ADAPT'BOX

### PRATIQUE

Transformez vos clés mixtes à cliquet en véritables cliquets.

Jeu de clés mixtes à cliquets + adaptateurs :

Les adaptateurs transforment les clés mixtes à cliquets en véritables cliquets et permettent d'utiliser les douilles et embouts.

### PRINCIPE

Clé mixte à cliquet de 10 mm + adaptateur 1/4" => cliquet 1/4"

Clé mixte à cliquet de 19 mm + adaptateur 1/2" => cliquet 1/2"

Clé mixte à cliquet de 10 mm + adaptateur embouts => porte-embouts à cliquet.

### GAIN DE PLACE

Coffret multifonction.

Grande compacité pour l'équivalent d'un jeu de clés mixtes à cliquet et 2 coffrets de douilles et embouts.



Adaptateur 1/4"



Adaptateur 1/2"



Adaptateur embouts



## COFFRET DE CLÉS MIXTES À CLIQUET ET DOUILLES + ADAPTATEURS

- 8 clés mixtes à cliquet : 8-10-11-12-13-15-17-19 mm.
- 12 douilles carré 1/4 : 4-5-5,5-6-7-8-9-10-11-12-13-14 mm.
- 7 douilles carré 1/2 : 10-13-14-16-17-18-19 mm.
- 3 adaptateurs : 14 - 1/2 - embouts.
- 14 embouts de vissage :
  - 2 fentes : 4-5,5
  - 2 phillips : PH1-PH2
  - 4 hexagonaux : H3-H4-H5-H6
  - 6 torx : T10-T15-T20-T25-T30-T45.



	L mm	l mm	H mm	g	Ref.	☐
44 pcs	405	225	60	2620	9436044001	1
					Ref.	☐
					ADAPTATEUR 10MM / 1/4	5
					ADAPTATEUR 19MM / 1/2	5
					ADAPTATEUR 10MM / EMBOUT	5





## CLÉS À FOURCHES

### ACCESSIBILITÉ

Finesse de la fourche pour une accessibilité optimale.

### PRÉCISION

Grande précision dimensionnelle des fourches.

### QUALITÉ

- Chrome vanadium.
- Dureté fourches : 46/50 HRC.



### NETTOYAGE FACILE ①

Reliefs et marquages doux réalisés en forge à froid pour un confort tactile et un nettoyage facile.

### ERGONOMIE ②

Profil étudié pour plus d'efficacité ; 15° d'inclinaison entre la tête et le corps de la clé. Légèreté et équilibre.

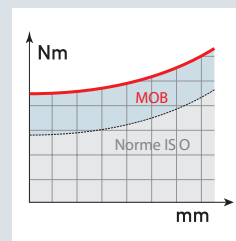
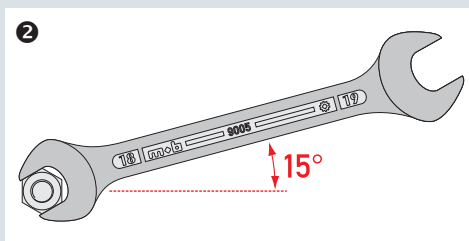
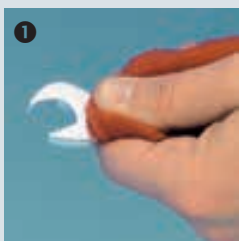

## CLÉS À FOURCHES

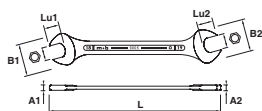

mm	L mm	B1 mm	B2 mm	A1/A2 mm	Lu1 mm	Lu2 mm	g	Ref.	
4x5	100	14	15	3,3	6,5	7	16	9005040001	5
5,5x7	122	17	19	3,5	7,8	8,7	23	9005050001	5
6x7	122	17	19	3,5	7,8	8,7	23	9005060001	5
8x10	138	21	25	4,3	9,6	11,4	37	9005A80001	5
8x9	138	21	23	4	9,6	10,5	33	9005080001	5
10x11	154	25	27	4,5	11,4	12,2	48	9005100001	5
10x12	154	25	29	5	11,4	13,1	55	90051A0001	5
10x13	171	25	31	5	11,4	14	64	9005B00001	5
11x13	171	27	31	5	12,2	14	65	9005110001	5
12x13	171	29	31	5	13,1	14	67	9005120001	5
12x14	171	29	33	5,3	13,1	14,9	73	9005B20001	5
13x15	187	31	35	5,5	14	15,7	97	9005B30001	5
13x17	203	31	39	6	14	17,5	123	9005130001	5
14x15	187	33	35	5,5	14,8	15,7	99	9005140001	5
14x17	203	33	39	6	14,9	17,5	125	9005B40001	5
16x17	203	37	39	6	16,6	17,5	130	9005160001	5
16x18	203	37	41	6,5	16,6	18,3	155	9005B60001	5

mm	L mm	B1 mm	B2 mm	A1/A2 mm	Lu1 mm	Lu2 mm	g	Ref.	
17x19	219	39	43	6,5	17,5	19,2	168	9005170001	5
18x19	219	41	43	6,7	18,3	19,2	174	9005180001	5
19x22	235	44	49	7,8	20	21,9	240	9005190001	5
20x21	235	45	47	7,3	20,1	21	230	9005C00001	5
20x22	235	45	49	7,3	20,1	21,9	234	9005200001	5
21x23	250	47	51	7,3	21	22,7	261	9005210001	5
21x24	250	47	53	8	21	23,6	235	9005C10001	1
22x24	250	49	53	7,5	21,9	23,6	272	9005220001	5
24x26	269	53	57	8,5	23,6	25,4	376	9005240001	1
24x27	269	53	59	9	23,6	26,3	400	9005C40001	1
25x28	285	55	61	8,5	24,5	27,1	418	9005250001	1
27x29	300	59	63	9	26,3	28	487	9005270001	1
27x30	300	59	65	9	26,3	28,9	495	9005C70001	1
27x32	300	59	69	10	26,3	30,7	535	9005D70001	1
30x32	316	65	69	10	28,9	30,7	548	9005300001	1
34x36	330	73	77	10	32,3	34	711	9005340001	1
36x41	360	77	87	11	34	38,2	907	9005360001	1





# CLÉS À FOURCHES

3 Clés à ouverture fixe et variable

## CLÉS À FOURCHES SUR CARTE

NF ISO 1711-10102-691-3318 / DIN 899-3110.



mm	L mm	g	Ref.	☐
10x11	154	48	9005101001	3
12x13	171	67	9005121001	3
14x15	187	99	9005141001	3
16x17	203	130	9005161001	3
18x19	219	174	9005181001	3
20x22	235	234	9005201001	3
21x23	250	261	9005211001	3
24x26	269	376	9005241001	1
27x29	300	487	9005271001	1
30x32	316	548	9005301001	1

## JEUX DE CLÉS À FOURCHES EN COFFRET BROCHABLE



	Contenu	g	Ref.	☐
8 pcs	6x7 - 8x9 - 10x11 - 12x13 - 14x15 - 16x17 - 18x19 - 20x22 mm	1010	9005000101	1
8 pcs	8x9 - 10x11 - 12x13 - 14x15 - 16x17 - 18x19 - 21x23 - 22x24 mm	1315	9005000201	1

## JEUX DE CLÉS À FOURCHES EN BOÎTE



	Contenu	g	Ref.	☐
8 pcs	6x7 - 8x9 - 10x11 - 12x13 - 14x15 - 16x17 - 18x19 - 20x22 mm	1100	9005000301	1
12 pcs	6x7 - 8x9 - 10x11 - 12x13 - 14x15 - 16x17 - 18x19 - 20x21 - 22x24 - 25x28 - 27x29 - 30x32 mm	2900	9005000501	1

## MODULE DE CLÉS À FOURCHES



	Contenu	L mm	l mm	H mm	g	Ref.	☐
9 pcs	6x7 - 8x9 - 10x11 - 12x13 - 14x15 - 16x18 - 17x19 - 20x22 - 22x24 mm	385	165	50	1220	9545009001	1

## TROUSSES DE CLÉS À FOURCHES



	Contenu	Lxl mm	g	Ref.	☐
6 pcs	8x9 - 10x11 - 12x13 - 14x15 - 17x19 - 21x23 mm	265x300	765	9501060001	1
12 pcs	6x7 - 8x9 - 10x11 - 12x13 - 14x15 - 16x17 - 18x19 - 20x22 - 21x23 - 24x26 - 27x29 - 30x32 mm	570x380	2680	9005012001	1

## CLÉS PHOSPHATÉES



Dites «clés de force».  
1 seul côté fourche.

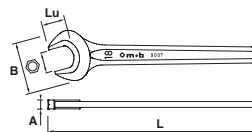

mm	L mm	B mm	A mm	Lu mm	g	Ref.	☐
7	80	16	4	8	15	9007070001	5
8	90	19	4	9	15	9007080001	5
9	100	21	4,5	10	20	9007090001	5
10	110	23	5	11	25	9007100001	5
11	120	25	5	12	30	9007110001	5
12	125	26	5	12	35	9007120001	5
13	130	29	6	13	40	9007130001	5
14	140	31	6	16	45	9007140001	5
15	150	35	7	17	60	9007150001	5
16	160	36	7	19	70	9007160001	5
17	158	37	6,5	18	65	9007170001	5
18	167	39	7	16	90	9007180001	5
19	180	41	7	17	105	9007190001	5
21	195	46	8	20	120	9007210001	5
22	200	46	8	21	145	9007220001	5
24	220	50	8	23	155	9007240001	1
27	240	56	10	25	225	9007270001	1
28	247	57	11	27	240	9007280001	1
30	260	62	12	28	320	9007300001	1
32	280	66	11	30	360	9007320001	1
34	290	71	13	32	395	9007340001	1
35	313	76	12,5	32	445	9007350001	1
36	320	77	13	32	470	9007360001	1
38	327	80	13	30	550	9007380001	1
40	350	86	13	31	630	9007400001	1
41	350	85	12	39	600	9007410001	1
42	350	86	14	30	645	9007420001	1
46	380	90	14	43	755	9007460001	1
48	400	100	15	41	925	9007480001	1
50	420	100	14	42	955	9007500001	1
55	460	110	16	51	1425	9007550001	1
60	500	122	18	57	1700	9007600001	1
65	537	130	18	60	2020	9007650001	1
70	545	140	19	70	2260	9007700001	1
75	580	154	24	73	3175	9007750001	1
80	625	160	23	80	3445	9007800001	1
85	675	170	22	85	4015	9007850001	1
90	700	183	22	95	4710	9007900001	1
95	740	190	24	98	5380	9007950001	1
100	800	195	25	105	7325	9007990001	1



## CLÉS À FRAPPER À OEIL



Phosphatées.  
DIN 7444.

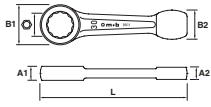

mm	L mm	B1 mm	B2 mm	A1 mm	A2 mm	g	Ref.	
24	158	43	32	14	12	270	9011240001	1
27	178	46	33	16	12	380	9011270001	1
30	191	52	38	17	14	500	9011300001	1
32	192	53	38	17	14	530	9011320001	1
36	210	59	43	19	18	760	9011360001	1
41	215	65	43	21	18	810	9011410001	1
46	243,5	73,5	48	23	20	975	9011460001	1
50	245	78,5	48	24	20	980	9011500001	1
55	270	86,5	56	25	22	1750	9011550001	1
60	272	89,5	56	27	22	1960	9011600001	1
65	300	102,5	62	29	26	2180	9011650001	1
70	305	108,5	62	33	26	2400	9011700001	1
75	330	113,5	68	34	30	2775	9011750001	1
80	348	124,5	68	36	30	3150	9011800001	1
85	360	128,5	78	37	32	4860	9011850001	1
90	379	148	78	40	32	5680	9011900001	1
95	395	150,5	87	40,5	36	6500	9011950001	1
100	405	153,5	87	44,5	36	7830	9011990001	1

## CLÉS À FRAPPER À FOURCHE



Phosphatées.  
DIN 475. DIN 133.

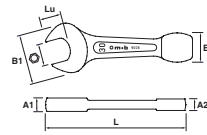

mm	L mm	B1 mm	B2 mm	A1 mm	A2 mm	Lu mm	g	Ref.	
24	160	48	31	14	11	23	290	9006240001	1
27	180	56	33	16	12	26	340	9006270001	1
30	190	65	38	17	15	28	550	9006300001	1
32	195	67	38	17	15	30	560	9006320001	1
36	210	77	43	18	18	34	845	9006360001	1
41	230	88	43	19	18	38	1040	9006410001	1
46	250	96	48	20	20	43	1375	9006460001	1
50	275	106	48	21	20	46	1670	9006500001	1
55	305	116	56	24	22	51	2175	9006550001	1
60	315	125	56	24	22	55	2455	9006600001	1
65	345	136	62	28	26	60	3550	9006650001	1
70	370	148	62	30	26	65	4075	9006700001	1
75	385	158	68	30	30	70	5170	9006750001	1
80	400	170	68	33	30	76	5785	9006800001	1
85	410	174	78	33	32	80	6870	9006850001	1
90	445	188	78	38	32	86	8165	9006900001	1
95	455	194	87	38	36	93	9620	9006950001	1
100	480	220	87	46	36	102	11880	9006990001	1

## GAMME ANTIDÉFLAGRANT

MOB propose une gamme de plus de 400 outils antidéflagrants en alliage Cuivre-Beryllium (Cu-Be) ou Aluminium-Bronze (Al-Brz). Ces outils sont réalisés sur demande. Ces produits sont conformes aux exigences des normes EN1127-1 (édition 2008), EN13463-1 (édition 2007) et EN13463-5



16



62



96



120



126



156



188



224



248



254



300



316



340



390



462



488



# CLÉS POLYGONALES

3 Clés à ouverture fixe et variable



## CLÉS POLYGONALES CONTRECOUDÉES

### FORME CONTRECOUDÉE ①

Bon dégagement grâce au coude et à l'angle de 110°.

### ERGONOMIE ET CONFORT

Corps de la clé non tranchant et long pour une bonne prise en main et pour l'application d'une force optimale.



### PERFORMANCE ②

Profil de protection permettant de travailler sans arrondir les angles de l'écrou.  
Acier Chrome Vanadium. Dureté oeil : 46/50 HRC.

### NETTOYAGE FACILE ③

Reliefs et marquages doux réalisés en forge à froid pour un confort tactile et un nettoyage facile.

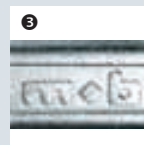
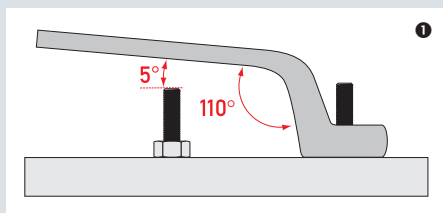

## CLÉS POLYGONALES CONTRECOUDÉES

NF ISO 3318 - 10103  
10104 - 691.

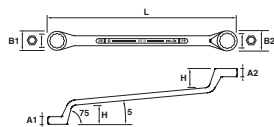

mm	L mm	B1 mm	B2 mm	A1 mm	A2 mm	H mm	g	Ref.	
6x7	183	10	11	5,5	6,5	19	54	9010060001	1
8x9	195	13	14	7	7,5	20,5	69	9010080001	1
10x11	210	16	17	8,5	9	22,5	93	9010100001	1
12x13	229	18,5	20	9,5	10	24,5	120	9010120001	1
14x15	244	21	22,5	10	11	26	156	9010140001	1
16x17	254	24	25	11,5	12	27,5	186	9010160001	1
18x19	267	26,8	28,5	12,5	13	29	230	9010180001	1
20x22	292	30	32,5	13,8	14,8	31,5	333	9010200001	1
21x23	314	31	34	14	14,5	33,5	398	9010210001	1
22x24	321	32,5	35,5	14,8	15	34,5	422	9010220001	1
24x26	322	35,5	38	15	15,5	34,5	470	9010240001	1
24x27	335	35,5	39	15	15	35	521	9010C40001	1
25x28	348	37	41	14	15	36	558	9010250001	1
27x29	351	39	47	15	16	36	697	9010270001	1
30x32	361	47	47	16	16	37	758	9010300001	1

## JEUX DE CLÉS POLYGONALES CONTRECOUDÉES EN BOÎTE



	Contenu	g	Ref.	
8 pcs	6x7 - 8x9 - 10x11 - 12x13 - 14x15 - 16x17 - 18x19 - 20x22 mm	1350	9010000201	1
8 pcs	8x9 - 10x11 - 12x13 - 14x15 - 16x17 - 18x19 - 21x23 - 22x24 mm	1875	9010000101	1
10 pcs	6x7 - 8x9 - 10x11 - 12x13 - 14x15 - 16x17 - 18x19 - 20x22 - 21x23 - 24x27 mm	2450	9010000301	1
12 pcs	6x7 - 8x9 - 10x11 - 12x13 - 14x15 - 16x17 - 18x19 - 20x22 - 22x24 - 25x28 - 27x29 - 30x32 mm	3990	9010000401	1

# CLÉS POLYGONALES ET À TUYAUTER



## CLÉS DEMI-LUNE

### PERFORMANCE

La forme particulière de ces clés permet de serrer un écrou en contournant un obstacle.



### PRATIQUE

Le profil 12 pans de MOB protège les écrous contre le matage.



## CLÉS DEMI-LUNE

NF ISO 3318.

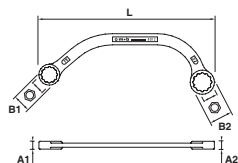

mm	L mm	B1 mm	B2 mm	A1/A2 mm	g	Ref.	
10x12	150	17	20,5	7	61	9012100001	1
11x13	150	17	20,5	7	61	9012110001	1
13x15	184	21	23	8	75	9012130001	1
14x17	185	21	25	8	83	9012140001	1
16x18	200	25	27	9	105	9012160001	1
19x22	235	28	32,5	10	157	9012190001	1



## CLÉS À TUYAUTER

### ERGONOMIE

Les clés à tuyauter bénéficient d'une tête œil moins encombrante qu'une clé à fourche permettant ainsi une meilleure accessibilité, la reprise aussi est améliorée.



### ACCESSIBILITÉ

Nombreux points de contact pour transmettre un serrage puissant :

- Le profil 12 pans de Mob protège les écrous contre le matage.
- Angle de reprise de 30°.

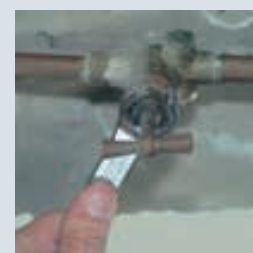

## CLÉS À TUYAUTER



DIN 3118.

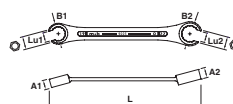

mm	L mm	B1 mm	B2 mm	A1 mm	A2 mm	Lu1 mm	Lu2 mm	g	Ref.	
7x9	118	17	20	6,5	7,5	5,5	6,5	36	9020070001	1
8x10	123	18	20	6,5	7,5	6	7,5	40	9020080001	1
11x13	153	22	26	8,5	10	8,5	10	70	9020110001	1
12x14	160	24	28	9	11	9	11	90	9020120001	1
17x19	202	32	35	12	13	14,5	15,5	145	9020170001	1
19x22	237	35	41	13	15	15,5	17	245	9020190001	1
24x27	265	45	48	16,5	17,5	18	20	395	9020240001	1
30x32	289	50	52	20	22	22,5	24	535	9020300001	1

## TROUSSE DE CLÉS À TUYAUTER



	Contenu	Lxl mm	g	Ref.	
6 pcs	7x9-8x10-11x13-12x14-17x19-19x22	265x300	630	9020006001	1





# CLÉS À MOLETTE



## CLÉS À MOLETTE

### ➤ RÉSISTANCE ET LONGÉVITÉ ①

La clé à molette "couple" surpasse les tests de résistance des normes ISO 6787 et NF E 74-324.

Guidage du mors mobile conçu pour une résistance supérieure à la torsion.

Système exclusif et breveté (brevet n° 02.03790).

Le couple atteint est exceptionnel, au-delà des leaders reconnus du marché.

Les jeux très faibles témoignent de la qualité de la clé.



### ➤ ERGONOMIE ②

Un outil conçu pour votre main. Légère et équilibrée.

Molette protégée : la clé ne se dérègle pas lorsqu'on la pose grâce à ses boutons d'appui (modèle déposé).

Une double graduation en millimètres et pouces pour un repérage et un travail plus précis.

### ➤ ACCESSIBILITÉ ③

Une inclinaison des mors étudiée pour pouvoir travailler horizontalement et dégager la prise.

- Une tête fine pour une accessibilité maximale.
- Crémaillère peu saillante : un encombrement minimum de la tête.
- Manche galbé : surface d'appui large et confort maximum.

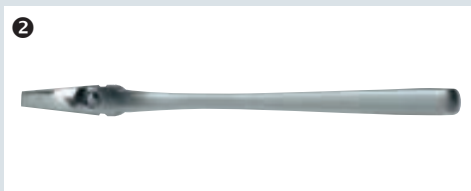
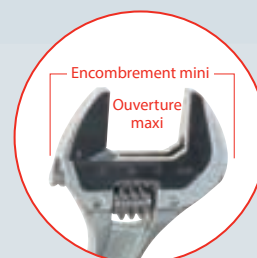



## CLÉS À MOLETTE COUPLE

NF ISO 6787 / DIN 3117.

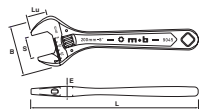

L mm	S mm	Lu mm	B mm	E mm	⚖ g	Ref.	📦
150-6"	24,5	20	60	11,5	160	9045150001	1
200-8"	28,5	23,5	61	14,5	300	9045200001	1
250-10"	33	30,5	70,5	16	480	9045250001	1
300-12"	38,5	34	82	16,5	760	9045300001	1
375-15"	51,5	46,5	108	23	1400	9045370001	1

## CLÉS À MOLETTE COUPLE SUR CARTE

NF ISO 6787 / DIN 3117.



L mm	S mm	Lu mm	B mm	E mm	⚖ g	Ref.	📦
150-6"	24,5	20	60	11,5	160	9045151001	1
200-8"	28,5	23,5	61	14,5	300	9045201001	1
250-10"	33	30,5	70,5	16	480	9045251001	1
300-12"	38,5	34	82	16,5	760	9045301001	1

## CLÉS À MOLETTE PHOSPHATÉES



L mm	B mm	Lu mm	S mm	E mm	⚖ g	Ref.	📦
150-6"	44	20	19	11	140	9044150101	1
200-8"	56	25	24	12,5	250	9044200101	1
250-10"	68,5	30	29	15	420	9044250101	1
300-12"	81,5	36	34	18	710	9044300101	1
375-15"	102	45	45	23	1320	9044370101	1

## MODULE DE 3 CLÉS À MOLETTE PHOSPHATÉES



3 pcs	Contenu	L mm	l mm	H mm	⚖ g	Ref.	📦
	200/250/300 mm	385	165	50	1410	9566003001	1

## CLÉS À MOLETTE CHROMÉES GAINÉES



L mm	B mm	Lu mm	S mm	E mm	⚖ g	Ref.	📦
200-8"	56	25	24	14,5	255	9044200401	1
250-10"	68,5	30	29	17	425	9044250401	1
300-12"	81,5	36	34	20	720	9044300401	1

## CLÉS À MOLETTE CHROMÉES

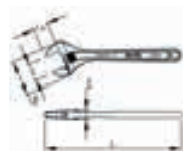

L mm	B mm	Lu mm	S mm	E mm	⚖ g	Ref.	📦
100-4"	40	15	18	10	60	9046100001	1
150-6"	44	20	19	11	140	9044150001	1
200-8"	56	25	24	12,5	250	9044200001	1
250-10"	68,5	30	29	15	420	9044250001	1
300-12"	81,5	36	34	18	710	9044300001	1
375-15"	102	45	45	23	1320	9044370001	1
450-18"	122,5	53	57,5	25	1920	9045450001	1
600-24"	147	64	70	31	3350	9046600001	1

## CLÉS À MOLETTE CHROMÉES SUR CARTE



L mm	B mm	Lu mm	S mm	E mm	⚖ g	Ref.	📦
150-6"	44	20	19	11	140	9044151001	1
200-8"	56	25	24	12,5	250	9044201001	1
250-10"	68,5	30	29	15	420	9044251001	1
300-12"	81,5	36	34	18	710	9044301001	1

## MODULE DE 3 CLÉS À MOLETTE CHROMÉES



3 pcs	Contenu	L mm	l mm	H mm	⚖ g	Ref.	📦
	Chrom. - 200/250/300 mm	385	165	50	1410	9566003101	1

## CLÉS À CRÉMAILLÈRE



L mm	B mm	Lu mm	S mm	E mm	⚖ g	Ref.	📦
230	60	29,5	62	16,5	510	9049230001	1
280	74	39	78	49,5	805	9049280001	1
375	80	36	82	21,5	1565	9049370001	1

## CLÉS À MOLETTE ESPAGNOLES

Réglage par molette latérale.



L mm	B mm	Lu mm	S mm	E mm	⚖ g	Ref.	📦
150-6"	44	20	19	11	140	9047150001	1
200-8"	56	25	24	12,5	250	9047200001	1
250-10"	68,5	30	29	15	420	9047250001	1
300-12"	81,5	36	34	18	710	9047300001	1



16



62



96



120



126



156



188



224



248



254



300



316



340



390



462



488



# CLÉS À MOLETTE

3 Clés à ouverture fixe et variable



## CLÉS À MOLETTE COMPACT' EXTRA-LARGE EFFILÉ

Capacité très importante par rapport à sa longueur et son poids.

### PRATIQUE 3 EN 1

Cette clé compacte permet de remplacer 3 clés à molette standard grâce à sa large ouverture :

- la 6'' a une capacité équivalente à une clé à molette standard de 6''+8''+10''
- la 8'' a une capacité équivalente à une clé à molette standard de 8''+10''+12''.



### CAPACITÉ

Ouverture des mâchoires de 60% à 79% plus grande qu'une clé à molette standard

- 6'' = 34mm
- 8'' = 38,5mm.

### MANIABILITÉ

Longueur et poids peu élevé par rapport à la grande capacité.



50% plus effilée



-34%

34% moins longue

### CLÉS À MOLETTE COMPACT' EXTRA-LARGE EFFILÉE SUR CARTE

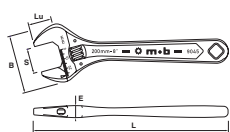

L mm	S mm	Lu mm	B mm	E mm	g	Ref.	☐
165	34	29	65	11,5	155	9043151401	1

### CLÉS À MOLETTE COMPACT' EXTRA-LARGE EFFILÉE SUR CARTE

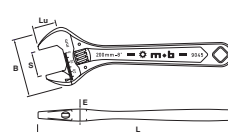

L mm	S mm	Lu mm	B mm	E mm	g	Ref.	☐
210	38,5	33	72	13,5	270	9043201401	1



# CLÉS EN CROIX ET CLÉS À BÉQUILLE



## CLÉS DE MONTEUR À FOURCHE CONTRECOUDEES



mm	L mm	H mm	g	Ref.	
17	320	29	195	9030170001	1
19	350	31.5	280	9030190001	1

## CLÉS DE MONTEUR À ŒIL CONTRECOUDEES



mm	L mm	H mm	g	Ref.	
17	310	27	220	9031170001	1
19	330	31	255	9031190001	1

## CLÉS DE MONTEUR À CLIQUET 2 DIMENSIONS



mm	L mm	H mm	g	Ref.	
17 - 19	315	50	480	9019170001	1
19 - 21	315	50	460	9019190001	1
21 - 22	315	50	450	9019210001	1

## CLÉS EN CROIX

### CLÉS EN CROIX

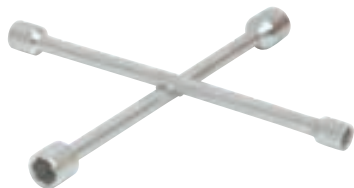
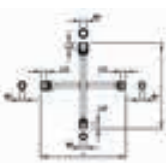

Dim. mm	L mm	ØD mm	Lu1 mm	Lu2 mm	Lu3 mm	g	Ref.	
16x19x21x23	350	20	17	18	19	1295	9022160001	1

### CLÉS EN CROIX AVEC CARRÉ

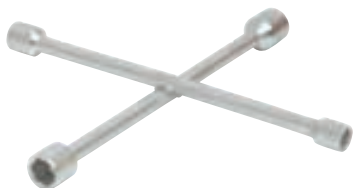
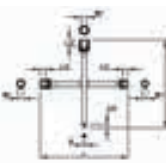

Dim. mm	L mm	ØD mm	Lu1 mm	Lu2 mm	Lu3 mm	g	Ref.	
17x19x22x1/2"	350	18	18	20	22	1950	9022170001	1

## CLÉS À BÉQUILLE

### CLÉS À BÉQUILLE À CARDAN



mm	L mm	l mm	g	Ref.	
8	390	200	410	9078080001	1
9	390	200	410	9078090001	1
10	500	200	500	9078100001	1
11	500	200	500	9078110001	1
12	500	200	500	9078120001	1
13	500	200	500	9078130001	1
14	500	200	500	9078140001	1
15	500	200	500	9078150001	1
16	500	200	500	9078160001	1
17	500	200	500	9078170001	1
18	500	200	500	9078180001	1
19	500	200	500	9078190001	1

### JEU DE 5 CLÉS À BÉQUILLE À CARDAN



	Contenu mm	g	Ref.	
5 pcs	8/10/12/13/14	2200	9078000101	1

### CLÉS À BOUGIE ARTICULÉES



mm	L mm	l mm	ØD mm	Ref.	
16	300	200	10	9079160001	1
21	300	200	10	9079210001	1



16



62



96

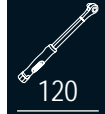

120



126



156



188

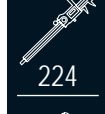

224



248



254



300



316



340



390

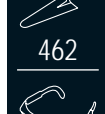

462

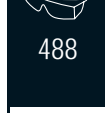

488



# 004

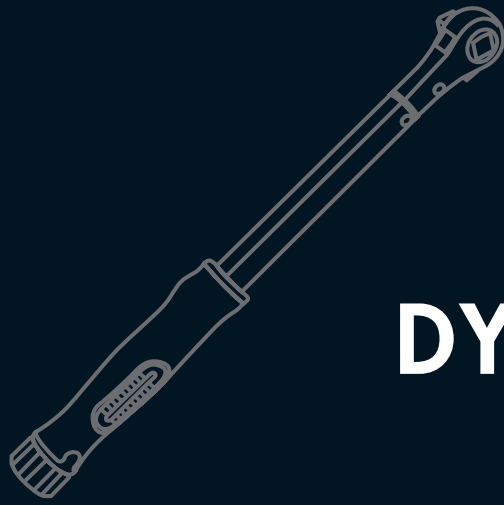

## DYNAMOMÉTRIE

### P.122

| CLÉS  
DYNAMOMÉTRIQUES  
3/8" ET 1/2"



### P.123

| CLÉS  
DYNAMOMÉTRIQUES  
3/4" ET 1"



### P.124

| TOURNEVIS  
DYNAMOMÉTRIQUES



### P.125

| LIMITEURS  
DE COUPLE 1/4"





# CLÉS DYNAMOMÉTRIQUES



## CLÉS DYNAMOMÉTRIQUES INITIAL

**INITIAL**

### CLÉ À DÉCLENCEMENT

- 1 clic et 1 à-coup signalent que le couple est atteint.
- Levier de changement de sens.
- Bouton de déverrouillage de la douille.
- 72 dents - Angle de reprise 5°.

### PRÉCISION

- Précision + ou - 3%, au-dessus des normes : BS EN 26789 - ISO 6789 - U.S.A. GGG-W-00686.
- Double système de réglage par vernier : approche rapide et réglage fin sur 2<sup>ème</sup> écran orange.
- Double échelle Nm et lbf.ft.

### SÉCURITÉ

- Calibrage du couple par rotation facile et démultipliée du manche.
- Bouton de verrouillage qui empêche toute modification involontaire de couple lors de l'utilisation de la clé.

### RÉSISTANCE

- Matériaux du manche et cadran résistants aux produits chimiques rencontrés dans l'industrie automobile et l'aéronautique.
- Tige de transmission d'effort traitée anticorrosion et facile à nettoyer.
- Cadran également résistant aux produits chimiques.
- Poignée bi-matière procurant une excellente prise en main même dans un environnement gras.

### TRACABILITÉ

- Numéro d'identification gravé sur la clé et spécifié sur le certificat d'étalonnage.
- Produit livré dans un coffret plastique avec certificat d'étalonnage et notice en français.



Double réglage, écran micro-métrique orange



Réglage par rotation du manche



Verrouillage du réglage

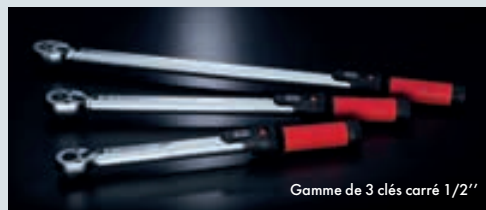
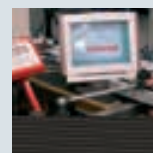
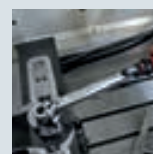

Gamme de 3 clés carré 1/2"

### CLÉ DYNAMOMÉTRIQUE INITIAL 3/8" - 1/2"



N.m	Carré	L mm	H mm	g	Ref.	☐
5-50	3/8	333	12	465	9074053801	1
10-100	1/2	400	15,8	855	9074101201	1
20-200	1/2	500	20,5	1120	9074201201	1
60-300	1/2	630	20,5	1475	9074341201	1



## CLÉS DYNAMOMÉTRIQUES 3/4" - 1"

### CLÉ DYNAMOMÉTRIQUE TÊTE FIXE À DÉCLENCEMENT

- Une fois le couple de serrage atteint, la clé se désarme automatiquement.
- Une mesure précise et un serrage contrôlé Norme ISO 6789.
- Clés légères et performantes en alliage d'aluminium.

### PRÉCISION

- Curseur d'indication de réglage du couple.
- Précision + ou - 4%.



### UTILISATION

- Levier de réglage du couple escamotable.
- Bonne préhension de la clé même dans des plages de couple élevées, grâce à leur corps rond.

### TRAÇABILITÉ

- Numéro d'identification gravé sur la clé et spécifié sur le certificat d'étalonnage.
- Produit livré dans un coffret bois avec certificat d'étalonnage.

### RÉSISTANCE

- Corps monobloc en alliage d'aluminium robuste et facile à nettoyer.
- Résistantes aux conditions sévères des chantiers, ateliers et environnements industriels.



Clé dynamométrique 3/4"



Clé dynamométrique 1"

### CLÉ DYNAMOMÉTRIQUE 3/4"



N.m	L mm	H mm	g	Ref.	☐
280-750	850	78	4750	9055070001	1

### CLÉ DYNAMOMÉTRIQUE 1"



Rallonge incluse.



N.m	L mm	H mm	g	Ref.	☐
750-2000	970-1600	87	10750	9055200001	1





## TOURNEVIS DYNAMOMÉTRIQUE

### PLAGE ET PRÉCISION

Plage de couple : 2 – 10 Nm  
 Vernier de réglage lisible, avec réglage fin  
 Conforme à la norme EN ISO 6789 +/-6%  
 Livré avec certificat d'étalonnage.



### UTILISATION

Tournevis dynamométrique de classe II type D (maintenance)  
 Tournevis à déclenchement.  
 Réarmement automatique tous les 120°.  
 Tournevis monosens : sens de serrage à droite.  
 Couple de desserrage illimité afin de pouvoir libérer les vis bloquées.  
 Sortie hexagonale femelle pour utilisation avec embouts.  
 Utilisation dans les espaces exigus grâce à la rallonge.  
 Utilisation avec douilles et accessoires grâce à l'embout porte-douilles.  
 Carré 1/4" sur le manche pour utilisation avec un cliquet.



## TOURNEVIS DYNAMOMÉTRIQUE



N.m	L mm	Ø mm	g	Ref.	1
2 - 10	160	34	280	9058020001	1

## BOX TOURNEVIS DYNAMOMÉTRIQUE 1/4" 42 PIÈCES



- 1 tournevis dynamométrique.
- 8 douilles 6 pans : 4/5/5,5/6/7/8/9/10 mm.
- 1 cliquet Premium rond // 1 rallonge porte-embouts // 1 embout porte-douilles.
- 30 embouts de vissage :
  - 5 fentes : 4/4,5/5,5/6,5/8.
  - 4 Phillips : PH0/PH1/PH2/PH3.
  - 6 Pozidriv : PZ0/PZ1x2/PZ2x2/PZ3.
  - 7 Torx : T10/T15/T20/T25/T27/T30/T40.
  - 8 hexagonaux : H1,5/H2/H2,5/H3/H4/H5/H6/H8.



42 pcs	Dimensions mm	g	Ref.	1
	135x215x60	1050	9416042001	1



## LIMITEURS DE COUPLE

### INNOVATION

C'est le porte-embout qui intègre la dynamométrie. Ils peuvent ainsi accueillir une infinité d'embouts et se monter sur tout support (poignée porte-embout ou autre). Dans le coffret compact, il n'y a pas moins de 240 possibilités (embouts x plages) pour une seule poignée. Une compacité appréciée par les utilisateurs en maintenance, qui font face à des situations très variées.

### COUPLE FIXE

Les couples sont pré-réglés en usine, pour une répétabilité parfaite. Dans le coffret les 8 couples se distinguent par une couleur différente. Chaque limiteur de couple peut correspondre à une application définie. Egalement idéal en milieu gras ou huileux, dans lesquels les réglages sont malvenus.

### PRÉCISION

La précision est de +/-8%.

### LA SÉCURITÉ DU DÉBRAYAGE

Le principe technique est le débrayage : à l'atteinte du couple déterminé, la poignée tourne dans le vide : l'embout et la vis arrêtent de tourner. Une sécurité appréciable pour les montages délicats et exigeants. La plupart des tournevis sont à déclenchement, c'est-à-dire que le serrage reste possible après le clic.

Vissage à couple fixé



### BOX LIMITEURS DE COUPLE 1/4" 49 PIÈCES

- 8 limiteurs de couple : 0,6 Nm - 0,9 Nm - 1,2 Nm - 1,4 Nm - 2 Nm - 3 Nm - 4 Nm - 5 Nm.
- 1 embout porte douilles // 1 poignée emmanchée //
- 30 embouts de vissage Schröder.
- 9 Torx : T6-T7-T8-T9-T10-T15-T20-T25-T27.
- 4 Torx plus : T10-T15-T20-T25.
- 4 Fentes : 3-4,5-5,5-6.
- 3 Pozidriv : PZ1-PZ2-PZ3.
- 3 Phillips : PH1-PH2-PH3.
- 7 Hexagonaux : H1,5-H2-H2,5-H3-H4-H5-H6.
- 9 douilles 6 pans : 3,2-4-5-5,5-6-7-8-9-10 mm.



16



62



96



120



126



156



188



224



248



254



300



316



340



390



462



488

	Dimensions mm	g	Ref.	
49 pcs	135x215x60	930	9050010001	1





# 005

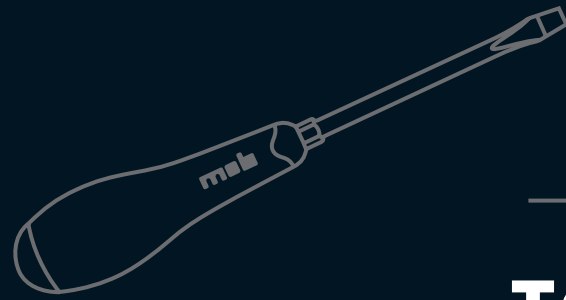

## TOURNEVIS, CLÉS MÂLES, EMBOUTS

**P.128**

**| TOURNEVIS  
MANCHE  
BI-MATIÈRE**



**P.137**

**| TOURNEVIS  
DE PRÉCISION  
MICRO**



**P.143**

**| CLÉS EMMANCHÉES**



**P.133**

**| TOURNEVIS MULTILAMES**



**P.138**

**| CLÉS MÂLES  
AIMANTÉES S2**



**P.143**

**| MAGNÉTISEUR-  
DÉMAGNÉTISEUR**



**P.134**

**| TOURNEVIS COUDÉS**



**P.139**

**| CLÉS MÂLES  
PROTANIUM**



**P.144**

**| EMBOUTS DE VISSAGE**



**P.134**

**| TOURNEVIS À FRAPPER**



**P.140**

**| CLÉS MÂLES  
CRV**



**P.151**

**| POIGNÉES,  
PORTE-EMBOUTS**



**P.135**

**| TOURNEVIS  
ISOLÉS 1000 V**



**P.142**

**| CLÉS EN T**



**P.155**

**| JEUX D'EMBOUTS**





# TOURNEVIS MANCHE BIMATIÈRE



## TOURNEVIS REDGRIP

FORCE - PRÉCISION - RAPIDITÉ



### ERGONOMIE

Combinaison de 2 matières : néoprène et polypropylène.  
Un couple très puissant grâce à la forme hexalobée.  
Les 6 lobes calent les doigts naturellement lors des serrages puissants.

### RAPIDITÉ

Amincissement du corps du tournevis pour le serrage rapide.  
Les avantages d'un tournevis à corps rond...  
- Forme adaptée à votre main.  
- Mouvement de reprise naturel.  
...et ceux d'un tournevis à corps carré ou triangulaire  
- Développement d'un couple puissant sans effort de serrage exagéré.  
- Posé, ne roule pas.



FINITION : Acier Chrome Vanadium forgé trempé.  
Chromée et polie satinée.



LAME SURMOULÉE : Indémanchable.

MARQUAGE : Marquage par tampographie de couleur sur le dessus du manche. Double marquage de la dimension : tampographie latérale sur le manche et marquage laser sur la lame.

### TÊTE SPHÉRIQUE DOUCE

- Forme adaptée à la poussée.  
- Marquage avec code couleur pour un repérage facile.

### PRATIQUE

- Grande visibilité de la couleur rouge : impossible à perdre.  
- Néoprène nouvelle génération : facile à nettoyer.

### QUALITÉ

- Une qualité d'acier Chrome Vanadium.  
- Empreinte phosphatée pour un meilleur grip.  
- Pas de risque d'éclat.

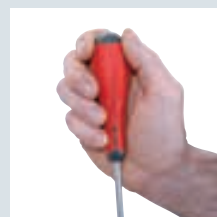
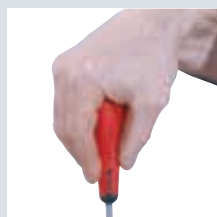
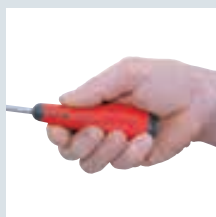

# TOURNEVIS MANCHE BIMATIÈRE



## TOURNEVIS D'ÉLECTRICIEN

NF ISO 2380 - DIN 5264.  
Lame fraisée.

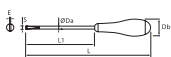

SxL1xE mm	L mm	ØDa mm	Db mm	g	Ref.	📦
2,5x50x0,4	140	2,5	23	20	9100010001	5
2,5x75x0,4	165	2,5	23	20	9100120001	5
3x50x0,5	140	3	23	25	9100020001	5
3,5x75x0,6	165	3,5	23	25	9100030001	5
3,5x100x0,6	190	3,5	23	30	9100040001	5
4x100x0,8	200	4	27	40	9100050001	5
4x150x0,8	250	4	27	45	9100060001	5
4x250x0,8	350	4	27	55	9100070001	5
5,5x100x1	200	5,5	27	50	9100130001	5
5,5x125x1	225	5,5	27	55	9100080001	5
5,5x150x1	250	5,5	27	60	9100090001	5
6,5x150x1,2	260	6,5	33	90	9100100001	5
6,5x200x1,2	310	6,5	33	105	9100110001	5

## TOURNEVIS D'ÉLECTRICIEN SUR CARTE

NF ISO 2380 - DIN 5264.  
Lame fraisée.



Dimensions mm	L mm	g	Ref.	📦
2,5x50x0,4	140	20	9100011001	3
3,5x75x0,6	165	25	9100031001	3
3,5x100x0,6	190	30	9100041001	3
4x100x0,8	200	40	9100051001	3
5,5x150x1	250	60	9100091001	3
6,5x150x1,2	260	90	9100101001	3

## TOURNEVIS DE MÉCANICIEN

NF ISO 2380 - DIN 5264.  
Lame forgée.

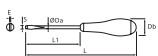

SxL1xE mm	L mm	ØDa mm	Db mm	g	Ref.	📦
4x100x0,8	200	4	25	40	9101080001	5
5,5x100x1	200	5	27	50	9101010001	5
5,5x125x1	225	5	27	50	9101020001	5
6,5x125x1,2	235	6	33	90	9101030001	5
6,5x150x1,2	260	6	33	95	9101040001	5
8x150x1,2	270	8	38	140	9101090001	5
8x200x1,2	320	8	38	155	9101100001	5
10x200x1,6	320	9,5	40	195	9101110001	5
10x250x2	370	9,5	38	225	9101070001	5

## TOURNEVIS DE MÉCANICIEN ÉCROU

NF ISO 2380 - DIN 5264.  
Avec écrou de reprise, lame forgée.

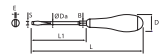

SxL1xE mm	L mm	ØDa mm	Db mm	B mm	g	Ref.	📦
6,5x150x1,2	260	6	33	8	85	9111020001	5
8x150x1,2	270	8	35	10	145	9111060001	5
10x200x1,6	320	9,5	38	13	205	9111070001	5
10x250x2	370	9,5	38	13	235	9111050001	5

## TOURNEVIS DE MÉCANICIEN SUR CARTE

NF ISO 2380 - DIN 5264.  
Lame forgée.



Dimensions mm	L mm	g	Ref.	📦
5,5x100x1	200	50	9101011001	3
6,5x150x1,2	260	80	9101041001	3
6,5x150x1,2 écrou	260	95	9111021001	3
8x150x1,2	270	140	9101051001	3

## TOURNEVIS PHILLIPS

NF ISO 8764.

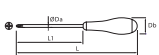

Type	L mm	ØDaxL1 mm	Db mm	g	Ref.	📦
PH0	165	3x75	23	25	9102010001	5
PH1	200	4,5x100	27	45	9102020001	5
PH2	235	6x125	33	80	9102030001	5
PH3	270	8x150	38	140	9102040001	5

## TOURNEVIS PHILLIPS ÉCROU

NF ISO 8764.  
Avec écrou de reprise.

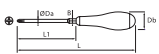

Type	L mm	ØDaxL1 mm	Db mm	B mm	g	Ref.	📦
PH2	260	6x150	33	8	85	9112020001	5
PH3	270	8x150	38	10	140	9112030001	5
PH4	320	10x200	38	13	205	9112040001	5

## TOURNEVIS PHILLIPS SUR CARTE

NF ISO 8764.



Type	L mm	g	Ref.	📦
PH0	165	25	9102011001	3
PH1	200	45	9102021001	3
PH2	235	80	9102031001	3



# TOURNEVIS MANCHE BIMATIÈRE

## TOURNEVIS POZIDRIV

NF ISO 8764.

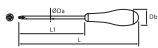

Type	L mm	∅DaxL1 mm	Db mm	g	Ref.	∅
PZ0	165	3x75	23	25	9103010001	5
PZ1	200	4,5x100	27	45	9103020001	5
PZ2	235	6x125	33	80	9103030001	5
PZ3	270	8x150	38	140	9103040001	5

## TOURNEVIS POZIDRIV ÉCROU

NF ISO 8764.

Avec écrou de reprise.

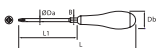

Type	L mm	∅DaxL1 mm	Db mm	B mm	g	Ref.	∅
PZ2	260	6x150	33	8	85	9113020001	5
PZ3	270	8x150	38	10	145	9113030001	5
PZ4	320	10x200	38	13	210	9113040001	5

## TOURNEVIS POZIDRIV SUR CARTE

NF ISO 8764.



Type	L mm	g	Ref.	∅
PZ0	165	25	9103011001	3
PZ1	200	45	9103021001	3
PZ2	235	80	9103031001	3
PZ2 écrou	260	85	9113021001	3

## TOURNEVIS TORX

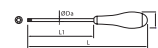

Type	L mm	∅DaxL1 mm	Db mm	g	Ref.	∅
T06	165	3x75	23	25	9104010001	5
T07	165	3x75	23	25	9104020001	5
T08	165	3x75	23	25	9104030001	5
T09	165	3x75	23	25	9104040001	5
T10	165	3x75	23	25	9104050001	5
T15	200	4,5x100	27	45	9104060001	5
T20	200	4,5x100	27	45	9104070001	5
T25	235	6x125	33	80	9104080001	5
T27	235	6x125	33	80	9104090001	5
T30	235	6x125	33	80	9104100001	5
T40	270	8x150	38	135	9104110001	5
T45	270	8x150	38	135	9104120001	5

## TOURNEVIS TORX SUR CARTE



Type	L mm	∅DaxL1 mm	Db mm	g	Ref.	∅
T10	165	3x75	23	25	9104051001	3
T15	200	4,5x100	27	45	9104061001	3
T20	200	4,5x100	27	45	9104071001	3
T25	235	6x125	33	80	9104081001	3
T30	235	6x125	33	80	9104101001	3
T40	270	8x150	38	135	9104111001	3

## TOURNEVIS TAMPER TORX

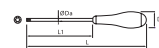

Type	L mm	∅DaxL1 mm	Db mm	g	Ref.	∅
TT8	175	4x75	23	25	9105080001	5
TT10	200	4,5x100	23	45	9105100001	5
TT15	200	4,5x100	23	45	9105150001	5
TT20	200	4,5x100	27	45	9105200001	5
TT25	235	6x125	33	80	9105250001	5
TT27	235	6x125	33	80	9105270001	5
TT30	235	6x125	33	80	9105300001	5
TT40	270	8x150	38	140	9105400001	5

## TOURNEVIS CARRÉ



Applications ciblées :  
industrie chimique...



Type	∅DaxL1 mm	g	Ref.	∅
S2	6X100	80	9106010001	5

## TOURNEVIS COURT À FENTE



NF ISO 2380 - DIN 5264.

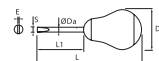

SxL1xE mm	L mm	∅Da mm	Db mm	g	Ref.	∅
4x38x0,8	96	4	40	40	9120010001	5
5,5x38x1	96	5	40	45	9121010001	5
6,5x38x1,2	96	6	40	45	9121020001	5

# TOURNEVIS MANCHE BIMATIÈRE



## TOURNEVIS COURT À FENTE SUR CARTE

NF ISO 2380 - DIN 5264.



Dimensions mm	L mm	g	Ref.	📦
4x38x0,8	96	40	9120011001	3
5,5x38x1	96	45	9121011001	3

## TOURNEVIS COURT PHILLIPS

NF ISO 8764.

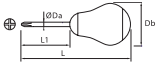

Type	L mm	ØDaxL1 mm	Db mm	g	Ref.	📦
PH1	96	4,5x38	40	40	9122010001	5
PH2	96	6x38	40	45	9122020001	5

## TOURNEVIS COURT PHILLIPS SUR CARTE

NF ISO 8764.



Type	L mm	ØDaxL1 mm	Db mm	g	Ref.	📦
PH1	96	4,5x38	40	40	9122011001	3
PH2	96	6x38	40	45	9122021001	3

## TOURNEVIS COURT POZIDRIV

NF ISO 8764.

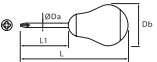

Type	L mm	ØDaxL1 mm	Db mm	g	Ref.	📦
PZ1	96	4,5x38	40	40	9123010001	5
PZ2	96	6x38	40	45	9123020001	5

## TOURNEVIS COURT POZIDRIV SUR CARTE

NF ISO 8764.



Type	L mm	g	Ref.	📦
PZ1	96	40	9123011001	3
PZ2	96	45	9123021001	3

## JEU DE 5 TOURNEVIS FENTE + PHILLIPS



9100  
4x100 - 5,5x150 - 6,5x150

9102  
PH1 - PH2

Contenu	g	Ref.	📦
4x100 - 5,5x150 - 6,5x150 - PH1 - PH2	485	9128005101	1

## JEU DE 5 TOURNEVIS SUR REGLETTE FENTE + PHILLIPS

Avec réglette.



9100  
4x100 - 5,5x150 - 6,5x150

9102  
PH1 - PH2

Contenu	g	Ref.	📦
4x100 - 5,5x150 - 6,5x150 - PH1 - PH2	485	9129000401	1

## JEU DE 5 TOURNEVIS SUR REGLETTE FENTE + POZIDRIV

Avec réglette.



9100  
4x100 - 5,5x150 - 6,5x150

9103  
PZ1 - PZ2

Contenu	g	Ref.	📦
4x100 - 5,5x150 - 6,5x150 - PZ1 - PZ2	485	9128005001	1

## JEU DE 6 TOURNEVIS FENTE + PHILLIPS



9100  
4x100x0,8 - 5,5x125x1 - 6,5x150x1,2 - 8x150x1,6

9102  
PH1 - PH2

Contenu	Dimensions mm	g	Ref.	📦
4x100 - 5,5x125 - 6,5x150 - 8x150 - PH1 - PH2	170x340x45	620	9129001101	1



16



62



96



120



126



156



188



224



248



254



300



316



340



390



462



488



131



# TOURNEVIS MANCHE BIMATERIÈRE

## JEU DE 6 TOURNEVIS FENTE + POZIDRIV



9100  
4x100x0,8 - 5,5x125x1 - 6,5x150x1,2 - 8x150x1,6

9103  
PZ1 - PZ2

Contenu	Dimensions mm	g	Ref.	
4x100 - 5,5x125 - 6,5x150 - 8x150 - PZ1 - PZ2	170x340x45	620	9129001201	1

## JEU DE 6 TOURNEVIS PHILLIPS + POZIDRIV



9103  
PZ1-PZ2-PZ3

9102  
PH1-PH2-PH3

Contenu	Dimensions mm	g	Ref.	
PH0 - PH1 - PH2 - PZ1 - PZ2 - PZ3	170x340x45	620	9129000601	1

## JEU DE 6 TOURNEVIS TORX



9104  
T10 - T15 - T20 - T25 - T30 - T40

Contenu	Dimensions mm	g	Ref.	
T10 - T15 - T20 - T25 - T30 - T40	170x340x45	585	9129000301	1

## JEU DE 6 TOURNEVIS TAMPER TORX



9105  
TT10 - TT15 - TT20 - TT25 - TT27 - TT30

Contenu	Dimensions mm	g	Ref.	
TT10 - TT15 - TT20 - TT25 - TT27 - TT30	170x340x45	620	9129000501	1

## JEU DE 7 TOURNEVIS FENTE + PHILLIPS + POZIDRIV



4x100 - 5,5x125 - 6,5x150

PZ1 - PZ2

PH1 - PH2

Contenu	Dimensions mm	g	Ref.	
4x100 - 5,5x125 - 6,5x150 - PZ1 - PZ2 - PH1 - PH2	170x340x45	565	9129100101	1

## JEUX DE 7 TOURNEVIS TORX + POZIDRIV



9103  
PZ1 - PZ2

9104  
T10 - T15 - T20 - T25 - T30

Contenu	Dimensions mm	g	Ref.	
T10 - T15 - T20 - T25 - T30 - PZ1 - PZ2	170x340x45	565	9129000701	1

## JEU DE 8 TOURNEVIS FENTE + PHILLIPS + POZIDRIV



9100  
4x100 - 5,5x125 - 6,5x150 - 8x150

9102  
PH1 - PH2

9102  
PZ1 - PZ2

Contenu	Dimensions mm	g	Ref.	
4x100 - 5,5x125 - 6,5x150 - 8x150 - PH1 - PH2 - PZ1 - PZ2	170x340x45	700	9129001901	1

## JEU DE 10 TOURNEVIS

- 2 Fentes
- 2 Philipps
- 2 Pozidriv
- 4 Torx
- 1 magnétiseur



9100  
4x100 - 6,5x150

9103  
PZ1 - PZ2

9606  
Magnétiseur-démagnétiseur

9102  
PH1 - PH2

9104  
T15 - T20 - T25 - T30

Contenu	Dimensions mm	g	Ref.	
4x100 - 6,5x150 - PH1 - PH2 - PZ1 - PZ2 - T15 - T20 - T25 - T30	235 x 370 x 45	1200	9129000801	1

# TOURNEVIS MANCHE BIMATIÈRE



## JEU DE 10 TOURNEVIS SUR RÉLETTE



3,5x75 - 4x100 -  
5,5x125 - 6,5x150  
- 8x150 - 10x200



PH1 - PH2



PZ1 - PZ2

Contenu	Dimensions mm	g	Ref.	📦
3,5x75 - 4x100 - 5,5x125 - 6,5x150 - 8x150 - 10x200 - PH1 - PH2 - PZ1 - PZ2	235 x 370 x 45	1190	9128010001	1

## MODULES THERMO DE 7 TOURNEVIS



	Contenu	g	Ref.	📦
x7	3,5x100-4x100 5,5x125-6,5x150 - 8x150 - PH1 PH2	705	9549007001	1
x7	3,5x100-4x100 5,5x125-6,5x150 - 8x150 - PZ1 PZ2	705	9549007101	1
x7	2,5x75-3,5x100-4x100-4x150-5,5x150-5,5x125-6,5x150	570	9549007401	1
x7	PH0-PH1-PH2 - PZ0-PZ1-PZ2 - 8x150	665	9549007501	1
x7	T8-T10-T15-T20-T25-T30-T40	660	9549007201	1

## MODULES MOUSSE DE 7 TOURNEVIS



	Contenu	g	Ref.	📦
x7	T10-T15-T20-T25-T27-T30-T40	635	9806007101	1
x7	TT10-TT15-TT20-TT25-TT27-TT30-TT40	620	9806007001	1

## MODULES MOUSSE DE 8 TOURNEVIS



	Contenu	g	Ref.	📦
x8	2,5x75-3,5x100-4x100-5,5x125-6,5x150-8x150 avec écrou-PH1-PH2	610	9805008001	1
x8	2,5x75-3,5x100-4x100-5,5x125-6,5x150-8x150 avec écrou-PZ1-PZ2	615	9805008101	1

## LAME RÉVERSIBLE



TOURNEVIS À LAMES INTERCHANGEABLES

### CARACTÉRISTIQUES

- Lames hexagonales 6,35mm 1/4", réversibles (2 empreintes par lame).
- Lames forgées, en acier au Silicium S3, de dureté des lames : 55 - 59 HRC.



- Longueur : 175 mm.
- Étui : 14 empreintes de vissage en 1 tournevis.
- Textile avec passant pour la ceinture.



## MANCHE TOURNEVIS BI-MATIÈRE POUR LAME RÉVERSIBLE



L mm	Ø	g	Ref.	📦
130	38	70	9150000001	5

## LAMES TOURNEVIS RÉVERSIBLES



Type	g	Ref.	📦
4 / 5,5	50	9150040501	5
6,5 / PH3	50	9150060301	5
PH1 / PH2	50	9152010201	5
PZ1 / PZ2	50	9153010201	5
T10 / T15	50	9154101501	5
T30 / T40	50	9154304001	5
H3	50	9157030001	5
H4	50	9157040001	5
H5	50	9157050001	5
H6	50	9157060001	5

## ÉTUI TOURNEVIS LAMES INTERCHANGEABLES 14 EMPREINTES

Étui textile avec passant pour la ceinture - 8 pièces.



4x0,5 - 5,5x0,8 - 6,5x1,2



PZ1 - PZ2



PH1 - PH2 - PH3



T10 - T15 - T20 - T25 - T30 - T40



g Ref.



440 9586008001



16



62



96



120



126



156



188



224



248



254



300



316



340



390



462



488



133



# TOURNEVIS

## COFFRET TOURNEVIS LAMES INTERCHANGEABLES 22 EMPREINTES

Coffret PEHD - mousse bicolore haute densité - 12 pièces.



4x0,5 - 5,5x0,8 - 6,5x1,2

PZ1 - PZ2

T10 - T15 - T20 - T25 - T30 - T40

PH1 - PH2 - PH3

H3 - H4 - H5 - H6 + H3 - H4 - H5 - H6 sphériques

g	Ref.	cube
970	9460012001	1

## TOURNEVIS COUDÉS

### TOURNEVIS COUDÉS



SxE mm	g	Ref.	cube
3,5x0,6	20	9130030001	1
4x0,8	37	9130050001	1
5,5x1	30	9130080001	1
8x1,2	75	9130120001	1

### TOURNEVIS COUDÉS PH1-PH2



Type	g	Ref.	cube
PH1 - PH2	20	9132050001	1



## TOURNEVIS À FRAPPER

Lame traversante permettant une frappe en bout de tournevis, sans abimer ce dernier et tout en conduisant l'effort de frappe.

Écrou de reprise

Manche en bois dur type hêtre.

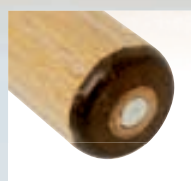
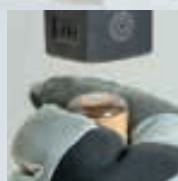
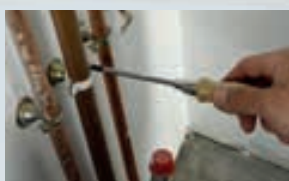

### TOURNEVIS À FRAPPER FENTE



SxLxE mm	L mm	ØDa mm	ØDb mm	g	Ref.	cube
5,5x100x0,8	200	5,5	25	65	9101010301	1
7x125x1	235	7	27	105	9101020301	1
9x150x1,2	270	8	30	165	9101030301	1
10,0x175x1,6	300	9	32	210	9101040301	1
12x200x2	330	9	32	270	9101050301	1
13x250x2,5	380	11	35	340	9101060301	1

### TOURNEVIS À FRAPPER TYPE POZIDRIV



Type	ØDaxL1 mm	L mm	ØDb mm	g	Ref.	cube
PZ1	4,5x85	180	24	50	9103010301	1
PZ2	6x100	210	27	90	9103020301	1
PZ3	8x150	270	30	130	9103030301	1



# TOURNEVIS ISOLÉS 1000 V



## TOURNEVIS ISOLÉS 1000 V MOB



### LA SÉCURITÉ DU TRAVAIL

Conformes à la norme européenne EN 60900. Outils pour travaux sous tension de 1000 V en courant alternatif et 1500 V en courant continu. L'isolation de chaque tournevis est testée à 10 000 V. La conformité à la norme des produits et du processus de fabrication est attestée par l'organisme de contrôle VDE-GS.

Le marquage des tournevis garantit cette qualité : 1000 V AC et VDE-GS.



### LA PERFORMANCE DES PRODUITS

L'isolation performante des lames est obtenue par injection.

- ① L'acier des lames est allié au chrome, vanadium et molybdène ; elles sont usinées et trempées pour obtenir la précision et la durabilité des extrémités.
- ② La poignée ergonomique bi-matière assure la puissance sans fatigue.

### TOURNEVIS ÉLECTRICIEN ISOLÉ 1000 V

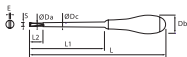

SxL1xE mm	L mm	L2 mm	ØDa mm	Db mm	ØDc mm	g	Ref.	📦
2,5x75x0,4	164	13	3,5	23	5,3	25	9100510001	1
3x75x0,6	164	13	3,5	23	5,3	25	9100520001	1
3,5x75x0,6	164	13	3,5	23	5,3	25	9100530001	1
4x100x0,8	198	13	4	28	5,8	40	9100550001	1
5,5x125x1	223	13	5,5	28	7,3	55	9100580001	1
6,5x150x1,2	257	13	6,5	33	8,3	90	9100600001	1

### TOURNEVIS ÉLECTRICIEN ISOLÉ 1000 V SUR CARTE



Dimensions mm	L mm	g	Ref.	📦
3,5x75x0,6	164	25	9100531001	1
4x100x0,8	198	40	9100551001	1
5,5x125x1	223	55	9100581001	1

### TOURNEVIS ISOLÉ 1000 V PHILLIPS



Type	L mm	L1 mm	L2 mm	ØDa mm	Db mm	ØDc mm	g	Ref.	📦
PH0	164	75	13	3,5	23	5,3	25	9102510001	1
PH1	198	100	16	4,5	28	6,3	45	9102520001	1
PH2	232	125	16	6	33	7,8	80	9102530001	1

### TOURNEVIS ISOLÉ 1000 V PHILLIPS SUR CARTE



Type	L mm	g	Ref.	📦
PH1	198	45	9102521001	1
PH2	232	80	9102531001	1



16



62



96



120



126



156



188



224



248



254



300



316



340



390



462



488



# TOURNEVIS ISOLÉS 1000 V

## TOURNEVIS ISOLÉ 1000 V POZIDRIV

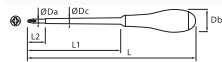

Type	L mm	L1 mm	L2 mm	ØDa mm	Db mm	ØDc mm	g	Ref.	📦
PZO	164	75	13	3,5	23	5,3	25	9103510001	1
PZ1	198	100	16	4,5	28	6,3	45	9103520001	1
PZ2	232	125	16	6	33	7,8	80	9103530001	1

## TOURNEVIS TESTEUR



L mm	L1 mm	D mm	SxE mm	g	Ref.	📦
135	60	12	3x0,8	25	9100630001	1

## TOURNEVIS TESTEUR SUR CARTE



L mm	S mm	E mm	g	Ref.	📦
135	3	0,8	25	9100631001	1

## TOURNEVIS ISOLÉ 1000 V BORNIER



Empreinte spéciale adaptée aux vis à empreintes mixtes rencontrées sur les appareillages électriques (borniers, contacteurs, relais, disjoncteurs, boîtiers...) - couple élevé - réduction du risque de ripage et d'usure des vis et du tournevis.

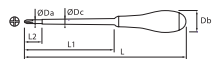

Type	L mm	L1 mm	L2 mm	ØDa mm	Db mm	ØDc mm	g	Ref.	📦
PZF1	198	100	16	4,5	28	6,3	45	9103521001	1
PZF2	232	125	16	6	33	7,8	80	9103531001	1

## TOURNEVIS ISOLÉ 1000 V BORNIER SUR CARTE



Empreinte spéciale adaptée aux vis à empreintes mixtes rencontrées sur les appareillages électriques (borniers, contacteurs, relais, disjoncteurs, boîtiers...) - couple élevé - réduction du risque de ripage et d'usure des vis et du tournevis.



Type	L mm	g	Ref.	📦
PZF1	198	45	9103521101	1
PZF2	232	80	9103531101	1

## JEU DE 6 TOURNEVIS ISOLÉS 1000V FENTE + PH



9100  
3,5x75x0,6 - 4x100x0,8 - 5,5x125x1 - 6,5x150x1

9102  
PH1 - PH2

Contenu	g	Ref.	📦
3,5x75x0,6 - 4x100x0,8 - 5,5x125x1 - 6,5x150x1 - PH1 - PH2	580	9129500101	1

## JEU DE 6 TOURNEVIS ISOLÉS 1000V FENTE + PZ



9100  
3,5x75x0,6 - 4x100x0,8 - 5,5x125x1 - 6,5x150x1

9103  
PZ1 - PZ2

Contenu	g	Ref.	📦
3,5x75x0,6 - 4x100x0,8 - 5,5x125x1 - 6,5x150x1 - PZ1 - PZ2	580	9129500201	1

## JEU DE 6 TOURNEVIS ISOLÉS 1000V PH + PZ



9103  
PZO - PZ1 - PZ2

9102  
PH0 - PH1 - PH2

9100  
testeur

Contenu	g	Ref.	📦
PH0 - PH1 - PH2 - PZO - PZ1 - PZ2 - Testeur	580	9129500301	1

## MODULE DE 7 TOURNEVIS ISOLÉS 1000V



Contenu	g	Ref.	📦
3,5x75-4x100-5,5x125-6,5x150 - PH1 - PZ1-PZ2	645	9549007301	1



## TOURNEVIS DE PRÉCISION MICRO

### SPÉCIAL PRÉCISION **micro**

- Empreinte phosphatée + lame chromée satinée
- Repérage facilité grâce aux anneaux de couleur pour chaque empreinte
- Cotes garanties.
- Tête pivotante et arrière du tournevis étudiés pour permettre une utilisation dans différentes positions

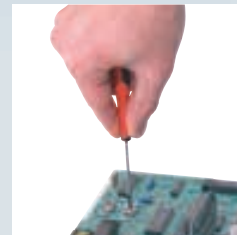
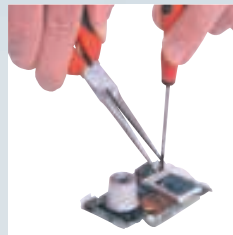

### TOURNEVIS MICRO ÉLECTRICIEN



SxLxE mm	L mm	ØDa mm	ØDb mm	▲ g	Ref.	☐
1,5x60x0,4	155	2,5	18	15	9160A10001	5
2x60x0,4	155	2,5	18	15	9160B10001	5
2,5X60X0,4	155	2,5	18	15	9160010001	5
3x60x0,5	155	3	18	15	9160020001	5

### TOURNEVIS MICRO PHILLIPS



Type	ØDaxL1 mm	L mm	ØDb mm	▲ g	Ref.	☐
PH000	2,5x60	155	18	15	9162A10001	5
PH00	2,5x60	155	18	15	9162B10001	5
PH0	3x60	155	18	15	9162010001	5
PH1	4x60	155	18	15	9162020001	5

### TOURNEVIS MICRO TORX



Type	ØDaxL1 mm	L mm	ØDb mm	▲ g	Ref.	☐
T6	2,5x60	155	18	15	9164010001	5
T7	2,5x60	155	18	15	9164020001	5
T8	2,5x60	155	18	15	9164030001	5
T9	3x60	155	18	15	9164040001	5
T10	3x60	155	18	15	9164050001	5

### TOURNEVIS MICRO HEXAGONAL



S mm	ØDaxL1 mm	L mm	ØDb mm	▲ g	Ref.	☐
1,5	2,5x60	155	18	15	9165030001	5

### JEU DE 6 TOURNEVIS MICRO

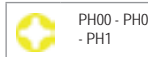

Contenu	▲ g	Ref.	☐
2x0,4 - 2,5x0,4 - 3x0,5 - PH00 - PH0 - PH1	175	9169010001	1

### JEU DE 12 TOURNEVIS MICRO

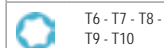

Contenu	▲ g	Ref.	☐
1,5x0,4 - 2x0,4 - 2,5x0,4 - 3x0,5 - PH00 - PH0 - PH1 - T6 - T7 - T8 - T9 - T10	265	9169020001	1

### JEUX DE 5 TOURNEVIS TORX MICRO



Contenu	▲ g	Ref.	☐
T6 - T7 - T8 - T9 - T10	165	9169000001	1



16



62



96



120



126



156



188



224



248



254



300



316



340



390



462



488



# CLÉS MÂLES AIMANTÉES



## CLÉS MÂLES AIMANTÉES S2



### UTILISATION

- Aimant intégré : idéal pour poser ou déposer les vis dans les endroits profonds ou difficiles d'accès.



### CARACTÉRISTIQUES

- Aimant véritable, ne perd pas son aimantation.
- L'étui s'ouvre pour un accès plus facile aux clés.
- Brochable sur crochet.
- Gainage PVC expansé souple, antiglisse et anti-graisse.
- Acier au Silicium S2, supérieur à l'acier Chrome Vanadium pour les clés mâles.



### GAMME

- Jeu clés mâles longues sphériques : 1,2/2/2,5/3/4/5/6/8/10mm, avec un côté long avec l'aimant, têtes hexagonales sphériques, en cas d'accès difficile, pour une utilisation inclinée.

- Jeu de clés Torx : T10/T15/T20/T25/T27/T30/T40/T45/T50, un côté Torx avec l'aimant, 1 côté Tamper Torx (court).



### ÉTUI DE 9 CLÉS MÂLES LONGUES SPHÉRIQUES AVEC AIMANT

Acier au Silicium S2.



### ÉTUI DE 9 CLÉS MÂLES TORX AVEC AIMANT

Acier au Silicium S2.

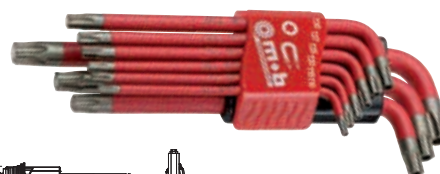

						Blister	
Contenu	L mm	H mm	E mm	g	Ref.		
1,2/2/2,5/3/4/5/6/8/10	43	60	25	354	9061020101	1	

					Blister		
Contenu	L mm	H mm	E mm	g	Ref.		
T10/T15/T20/T25/T27/T30/T40/T45/T50	45	56	25	166	9064020101	1	



## CLÉS MÂLES PROTANIUM

### TRAITEMENT DE SURFACE

Les clés mâles Protanium bénéficient d'une finition anti-corrosion exceptionnelle (brevet déposé).  
 Traitement qui permet de créer une couche imperméable sans aucune aspérité.  
 5 fois plus résistant à la corrosion que la finition classique.  
 Acier spécial 20 % plus résistant qu'un acier classique.



### ACIER PROTANIUM. TENUE AU COUPLE EXCEPTIONNELLE.

- Très grande précision dimensionnelle.
- Très au-dessus des normes ISO 2936.

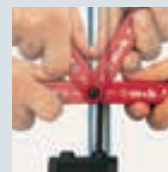

### ERGONOMIE

L'étui se transforme en poignée et vous permet d'exercer des serrages plus puissants.  
 Identification claire des dimensions grâce au marquage de l'étui.

Possibilité de travailler avec une inclinaison de 30° pour favoriser votre accessibilité.

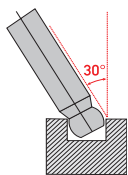

Facilite le positionnement de la clé.

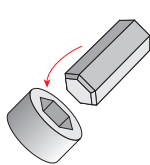

Test comparatif de 2 clés mâles : la moins résistante casse

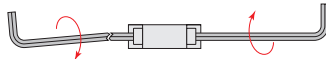

Clé extra-longue pour un couple supérieur



### ÉTUI DE 9 CLÉS MÂLES LONGUES SPHÉRIQUES, PROTANIUM

Acier allié Protanium.



Contenu	L étui mm	H mm	E mm	g	Ref.	Blister	Ref.
1,5 - 2 - 2,5 - 3 - 4 - 5 - 6 - 8 - 10	38	73	27	350	9051010101	1	9051011101

### ÉTUI DE 9 CLÉS MÂLES, PROTANIUM

Acier allié Protanium.



Contenu	L étui mm	H mm	E mm	g	Ref.	Blister	Ref.
1,5 - 2 - 2,5 - 3 - 4 - 5 - 6 - 8 - 10	37	73	27	250	9052010101	1	9052011101

### MONTURE DE 7 CLÉS MÂLES, PROTANIUM

Acier allié Protanium -  
 monture plastique.



Contenu	L étui mm	H mm	E mm	g	Ref.
2 - 2,5 - 3 - 4 - 5 - 6 - 8	113	26	35	170	9052010201

### MONTURE DE 8 CLÉS TORX, PROTANIUM

Acier allié Protanium -  
 monture plastique.



Contenu	L étui mm	H mm	E mm	g	Ref.
T9/T10/T15/T20/T25/T27/T30/T40	111	24	36	146	9053010201





# CLÉS MÂLES

## CLÉS MÂLES LONGUES SPHÉRIQUES

NF ISO 2936 - DIN 911.  
Acier allié Protanium.



S mm	L mm	H mm	▲ g	Ref.	☐
1,5	77	13,5	1,4	9051010001	10
2	82	15,5	2,7	9051020001	10
2,5	89	17,5	4,5	9051A20001	10
3	99	19	7,2	9051030001	10
4	110	24	15	9051040001	10
5	120	27	26	9051050001	10
6	139	31	44	9051060001	5
7	150	33	65	9051070001	5
8	162	35	90	9051080001	5
9	175	37	123	9051090001	5
10	188	39	155	9051100001	5

## CLÉS MÂLES

NF ISO 2936 - DIN 911.  
Acier allié Protanium.



S mm	L mm	H mm	▲ g	Ref.	☐
1,5	44	13,5	0,8	9052010001	10
2	49	15,5	1,7	9052020001	10
2,5	55	17,5	3	9052A20001	10
3	62	19	4,8	9052030001	10
4	68	24	10	9052040001	10
5	78	27	18	9052050001	10
6	88	31	29	9052060001	5
7	94	33	42	9052070001	5
8	98	35	58	9052080001	5
9	102	37	77	9052090001	5
10	109	39	101	9052100001	5
12	122	44	165	9052120001	5

## CLÉS MÂLES SUR CARTE

NF ISO 2936 - DIN 911.  
Têtes hexagonales.  
Acier allié Protanium.

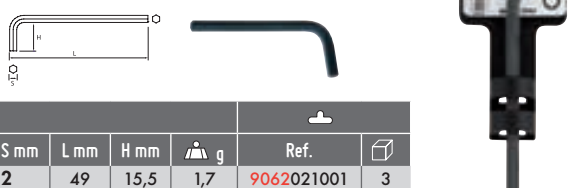

S mm	L mm	H mm	▲ g	Ref.	☐
2	49	15,5	1,7	9062021001	3
2,5	55	17,5	3	9062A21001	3
3	62	19	4,8	9062031001	3
4	68	24	10	9062041001	3
5	78	27	18	9062051001	3
6	88	31	29	9062061001	3
7	94	33	42	9062071001	3
8	98	35	58	9062081001	3
9	102	37	77	9062091001	3
10	109	39	101	9062101001	3



## CLÉS MÂLES CRV

### QUALITÉ

- Acier Chrome-Vanadium :  
qualité professionnelle  
garantie NF ISO 2936.

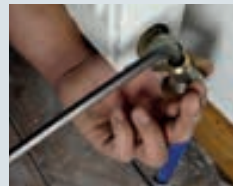

**CRV**  
chrome-vanadium



### GAMME

- Gamme longue et extra-longue pour un couple supérieur et une bonne accessibilité ❶
- Disponible en tête sphérique pour travailler avec une inclinaison de 30° pour favoriser l'accessibilité ❷
- Etui plastique : se transforme en poignée et permet d'exercer des serrages plus puissants. Identification claire des dimensions grâce au marquage ❸
- Monture : les clés restent dans la monture et pivotent à 180°. Tient dans la poche ❹.

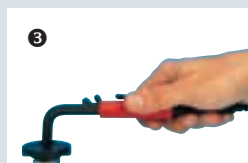
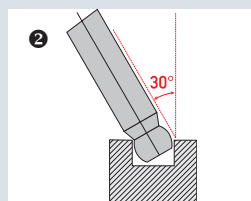
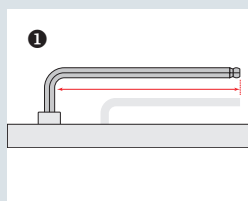

## ÉTUI DE 9 CLÉS MÂLES EXTRA-LONGUES SPHÉRIQUES - CRV

Chrome Vanadium - brochant.

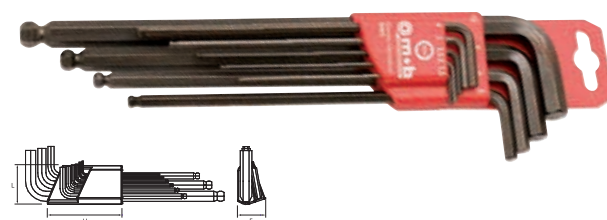

Contenu	L étui mm	H mm	E mm	▲ g	Ref.	☐
1,5 - 2 - 2,5 - 3 - 4 - 5 - 6 - 8 - 10	43	60	25	407	9065010101	1





## ÉTUI DE 9 CLÉS MÂLES LONGUES SPHÉRIQUES - CRV

Chrome Vanadium - brochant.



							Blister	
Contenu	L étui mm	H mm	E mm	g	Ref.	Ref.	Blister	
1,5 - 2 - 2,5 - 3 - 4 - 5 - 6 - 8 - 10	43	60	25	354	9061010101	9061011101	1	

## ÉTUI DE 10 CLÉS MÂLES SPHÉRIQUES - POUÇES

Chrome Vanadium - brochant.



Contenu	L mm	H mm	E mm	g	Ref.	Blister
1/2 - 3/8 - 5/16 - 1/4 - 3/16 - 5/32 - 1/8 - 3/32 - 5/64 - 1/16	43	60	25	620	9071010001	1

## ÉTUI DE 9 CLÉS MÂLES LONGUES - CRV

Chrome Vanadium - brochant.



Contenu	L étui mm	H mm	E mm	g	Ref.	Blister
1,5 - 2 - 2,5 - 3 - 4 - 5 - 6 - 8 - 10	43	60	25	410	9061009001	1

## ÉTUI DE 9 CLÉS MÂLES - CRV

Chrome Vanadium.



							Blister	
Contenu	L mm	H mm	E mm	g	Ref.	Blister		
1,5 - 2 - 2,5 - 3 - 4 - 5 - 6 - 8 - 10	45	60	20	246	9062011101	1		

Sans crochet de suspension		Avec crochet de suspension	
Ref.	Blister	Ref.	Blister
9062012101	1	9062010101	1

## ÉTUI DE 8 CLÉS MÂLES TORX SPHÉRIQUES - CRV

Chrome Vanadium - brochant.



Contenu	L étui mm	H mm	E mm	g	Ref.	Blister
T9/T10/T15/T20/T25/T27/T30/T40	45	56	24	166	9066010201	1

## ÉTUI DE 8 CLÉS MÂLES TAMPER TORX, CRV

Chrome Vanadium - brochant.



							Blister	
Contenu	L étui mm	H mm	E mm	g	Ref.	Blister		
TT9/TT10/TT15/TT20/TT25/TT27/TT30/TT40	45	56	24	166	9064010101	9064011101	1	

## MONTURES DE CLÉS MÂLES, CRV

Chrome Vanadium - montage bi-matière brochant.



Nb pièces	Contenu	L étui mm	H mm	E mm	g	Ref.	Blister
x 6	2,5 - 3 - 4 - 5 - 6 - 8	120	35	30	174	9062011201	1
x 7	1,5 - 2 - 2,5 - 3 - 4 - 5 - 6	120	32	30	180	9062006101	1
x 7	2,5 - 3 - 4 - 5 - 6 - 8 - 10	128	35	35	290	9062006001	1

## MONTURE DE CLÉS TAMPER TORX, CRV

Chrome Vanadium - montage bi-matière brochant.



Nb pièces	Contenu	L étui mm	H mm	E mm	g	Ref.	Blister
x 8	TT9/TT10/TT15/TT20/TT25/TT27/TT30/TT40	130	37	33	210	9064011201	1

## JEU DE 8 CLÉS MÂLES SUR ANNEAU, CRV

Chrome Vanadium - montées sur anneau.



Nb pièces	Contenu	g	Ref.	Blister
x 8	1,5 - 2 - 2,5 - 3 - 4 - 5 - 6 - 8	150	9062008001	1

## TROUSSE DE CLÉS MÂLES, CRV

Chrome Vanadium - trousse plastique.



Nb pièces	Contenu	g	Ref.	Blister
x 10	2 - 2,5 - 3 - 4 - 5 - 6 - 7 - 8 - 9 - 10	150	9062010901	1





# CLÉS MÂLES EN T



## CLÉS MÂLES EN T

### QUALITÉ

- Construction forgée 1 pièce, beaucoup plus résistant qu'une clé soudée.
- Acier au Chrome Vanadium.
- Empreinte principale phosphatée, pour un meilleur grip et une absence d'éclat.

### POIGNÉE EN T

- Poignée bimatière : polypropylène noir et Néoprène nouvelle génération, facile à nettoyer et résistant aux conditions d'atelier.
- Forme étudiée pour un serrage puissant et rapide.

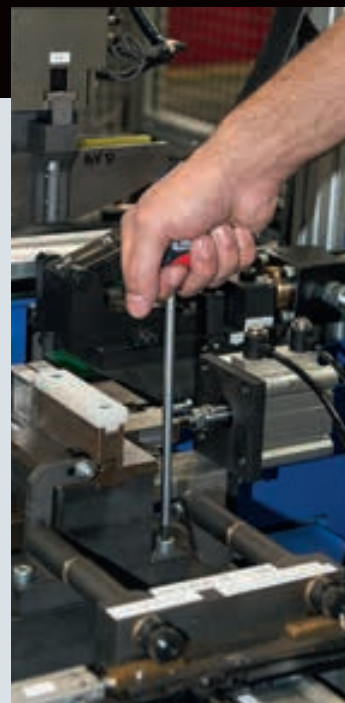

### CLÉS MÂLES EN T 6 PANS

Acier au Chrome Vanadium.  
Forgée 1 pièce. Poignée bimatière.



S mm	L mm	L1 mm	H mm	E mm	g	Ref.	
2,5	150	100	93	18,5	40	9067A20001	1
3	150	100	96	18,5	50	9067030001	1
4	150	100	96	18,5	60	9067040001	1
5	218	150	127	23,2	110	9067050001	1
6	218	150	127	23,2	140	9067060001	1
8	268	200	132	23,2	210	9067080001	1
10	268	200	132	23,2	280	9067100001	1

### CLÉS MÂLES EN T SPHÉRIQUES 6 PANS

Acier au Chrome Vanadium.  
Forgée 1 pièce. Poignée bimatière.



S mm	L mm	L1 mm	H mm	E mm	g	Ref.	
4	150	100	96	18,5	50	9068040001	1
5	218	150	127	23,5	110	9068050001	1
6	218	150	127	23,5	140	9068060001	1
8	268	200	132	23,5	210	9068080001	1
10	268	200	132	23,5	280	9068100001	1

### CLÉS TORX EN T

Acier au Chrome Vanadium.  
Forgée 1 pièce. Poignée bimatière.

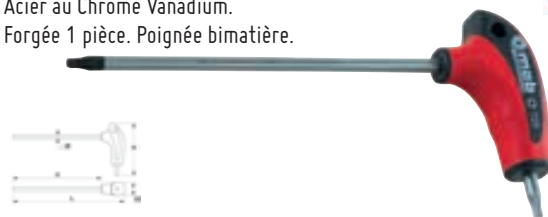

Type	L mm	ØDaxL1 mm	H mm	E mm	g	Ref.	
T8	142	4x110	70	19	29	9069080001	1
T9	142	4x110	70	19	29	9069090001	1
T10	142	4x110	70	19	29	9069100001	1
T15	142	4x110	70	19	29	9069150001	1
T20	142	4x110	70	19	29	9069200001	1
T25	206	6x160	93	25	85	9069250001	1
T27	206	6x160	93	25	86	9069270001	1
T30	206	6x160	93	25	86	9069300001	1
T40	231	7x185	93	25	112	9069400001	1
T50	270	9,5x215	122	25	140	9069500001	1

### CLÉS EMMANCHÉES EN T

Acier au Chrome Vanadium.  
Forgée 1 pièce. Poignée bimatière.



mm	L mm	L1 mm	E mm	H mm	ØD mm	ØDa mm	g	Ref.	
5	208	140	23.2	112	7	9	135	9073050001	1
6	208	140	23.2	112	7	9	135	9073060001	1
7	208	140	23.2	112	7	11.5	155	9073070001	1
8	208	140	23.2	112	7	11.5	145	9073080001	1
10	208	140	23.2	112	7	13.5	145	9073100001	1
11	208	140	23.2	112	7	17	175	9073110001	1
12	208	140	23.2	112	7	17	165	9073120001	1
13	208	140	23.2	112	7	20	180	9073130001	1
14	208	140	23.2	112	7	20	175	9073140001	1





## JEU DE 6 CLÉS MÂLES EN T HEXAGONALES

Sphériques : 4-5-6-8 mm et non sphériques : 2.5-3 mm - Acier Chrome Vanadium - Tige forgée 1 pièce, sans soudure. Présenté en coffret carton brochant.



	Contenu	Ref.	📦
x 6	2,5-3-4-5-6-8 mm	9068006101	1

## MODULE MOUSSE 7 CLÉS MÂLES EN T HEXAGONALES

Sphériques de 4 à 10 mm - non sphériques jusqu'à 3 mm - acier Chrome Vanadium - Tige forgée 1 pièce, sans soudure.



	Contenu	L mm	E mm	H mm	🏋️ g	Ref.	📦
x 7	2,5-3-4-5-6-8-10 mm	260	95	80	1580	9820007001	1

## MODULE MOUSSE 7 CLÉS MÂLES EN T TORX

T9/T10/T15/T20/T25/T30/T40 - acier Chrome Vanadium - Tige forgée 1 pièce, sans soudure.



	Contenu	L mm	E mm	H mm	🏋️ g	Ref.	📦
x 7	T9/T10/T15/T20/T25/T30/T40	260	95	80	1580	9821007001	1

## MODULE MOUSSE DE 8 CLÉS EMMANCHÉES EN T

Clés douillées en T 6/7/8/10/11/12/13/14 mm. Prend la place de 2 modules.



Contenu	🏋️ g	Ref.	📦
6 - 7 - 8 - 10 - 11 - 12 - 13 - 14	1680	9822008001	1

## CLÉS FLEXIBLES

### CLÉS EMMANCHÉES FLEXIBLES

Pour serrer les écrous en toute situation - idéal pour les colliers type Serflex.



🌀 mm	L mm	L1 mm	L2 mm	E mm	🏋️ g	Ref.	📦	Ref.	📦
6	260	10	28	38	120	9180060001	1		
7	260	10	28	38	140	9180070001	1	9180071001	1
8	260	10	28	38	135	9180080001	1		
10	260	10	28	38	150	9180100001	1		



## MAGNÉTISEUR-DÉMAGNÉTISEUR

### UTILISATION

- Permet l'aimantation des tournevis et clés mâles.
- Aide au placement et à la tenue de la vis.
- Le + aimante la lame acier avec la vis.
- Le - désaimante la lame après utilisation.



- Boîtier plastique résistant
- Dimensions 50x50x29 mm



### MAGNÉTISEUR-DÉMAGNÉTISEUR

Sur carte



Dimensions mm	🏋️ g	Ref.	📦
50x50x29	85	9606000001	1



16



62



96



120



126



156



188



224



248



254



300



316



340



390



462



488



# EMBOUITS DE VISSAGE



## EMBOUITS DE VISSAGE

### 2 GAMMES

- Silicium S2, de qualité réputée.
- Alliage 73MoV52, de qualité supérieure, exclusivité de l'usine Schröder en Allemagne, dont MOB a repris l'activité outillage à main en 2012.

### 2 FINITIONS SCHRÖDER



Derrière leur aspect classique se cache une supériorité de qualité : l'acier KSZ, bien meilleur que le S2 (Silicium), pourtant très réputé. Son secret : l'alliage 73MoV52. Le Molybdène apporte des qualités mécaniques inédites de résistance, souplesse et transmission du couple. La dureté est de 58-60 Hrc. Reconnaisable par sa couleur Acier.



Le revêtement TiN est réputé pour sa dureté de surface élevée, indispensable lors du vissage en série, de tous types (acier et bois). La dureté de surface atteint 90 Hrc. Nitrure de Titane, par procédé CVD, pour les embouts Titane. Reconnaisable par sa couleur dorée.



## EMBOUITS FENTE

### ORIGINE

- C'est historiquement l'une des premières empreintes, car elle est très facile à réaliser.

### PARTICULARITÉS

- Forme fendue dite également «plate»
- Le couple se répartit sur l'ensemble du diamètre de la vis, donc peut être élevé.
- En revanche, l'embout n'est pas contraint et peut glisser.
- Elle reste néanmoins très utilisée par les électriciens pour de petites vis avec logement, et par les mécaniciens pour son couple élevé.
- Pour être efficace, la largeur de l'embout compte aussi et doit être identique à celle de l'empreinte

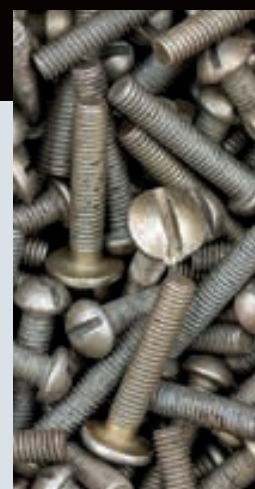

### EMBOUT FENTE CLASSIC 1/4 - C6,3



	L mm	▲ g	Ref.	☐
0,5x4,0	25	5	20210	10
0,6x4,5	25	5	20220	10
0,8x5,5	25	5	20240	10
1,0x6,0	25	5,5	20250	10
1,2x6,5	25	6	20260	10
1,6x8,0	25	7	20290	10



## EMBOUT PHILLIPS

### ORIGINE

- Inventée en 1933 par John P. Thompson et développée par Henry F. Phillips aux Etats-Unis

### PARTICULARITÉS

- Cruciforme, elle présente une meilleure tenue par rapport à une vis fente  
 - Encore répandue dans le monde et surtout utilisée par les plaquistes (voir aussi l'embout spécial plaquiste dans le chapitre Second œuvre)



### EMBOUT PHILLIPS CLASSIC 1/4 - C6,3



	L mm	▲ g	Ref.	☐
PH1	25	5	20010	10
PH2	25	5	20020	10
PH3	25	5,5	20030	10

### EMBOUT PHILLIPS TIN 1/4 - C6,3



	L mm	▲ g	Ref.	☐
PH1	25	5	21010	10
PH2	25	5	21020	10
PH3	25	5,5	21030	10

### EMBOUT PHILLIPS CLASSIC LONG 1/4 - E6,3



	L mm	▲ g	Ref.	☐
PH1	50	11,5	23010	10
PH2	50	12	23020	10
PH2	70	16	23050	10
PH3	50	12	23030	10

### EMBOUT PHILLIPS CLASSIC LONG 1/4 - C6,3



	L mm	▲ g	Ref.	☐
PH2	50	12	20080	10

### EMBOUT PHILLIPS CLASSIC EXTRA LONG 1/4 - E6,3



	L mm	▲ g	Ref.	☐
PH1	90	17	23070	10
PH2	90	20,5	23080	10



16



62



96



120



126



156



188



224



248



254



300



316



340



390



462



488



145



# EMBOUS POZIDRIV



## EMBOUS POZIDRIV

### ORIGINE

- Invention commune de American Screw Company et Phillips Screw Company
- Plus récente que la vis Phillips, sa première utilisation date de 1936 sur les Cadillac

### PARTICULARITÉS

- Forme 4 branches principales et 4 petites branches décalées
- Forme plus performante que la vis Phillips : une éjection de l'embout en fin de serrage grâce à l'inclinaison des flancs de l'empreinte (ce qui évite le dérapage de l'outil), le couple de serrage est supérieur et l'engagement de l'embout est rapide.
- Même si les embouts semblent compatibles entre Pozidriv et Phillips, utiliser le mauvais embout entraîne une usure des vis.

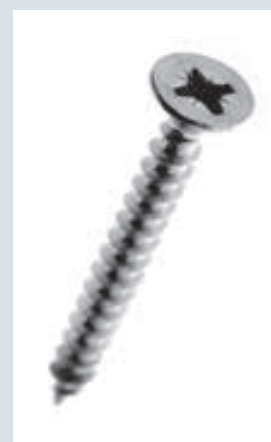

### EMBOUS POZIDRIV CLASSIC 1/4 - C6,3



	L mm	g	Ref.	☐
PZ1	25	5	20110	10
PZ2	25	5	20120	10
PZ3	25	5,5	20130	10

### EMBOUS POZIDRIV TIN 1/4 - C6,3



	L mm	g	Ref.	☐
PZ1	25	5	21110	10
PZ2	25	5	21120	10
PZ3	25	5,5	21130	10

### EMBOUS POZIDRIV CLASSIC LONG 1/4 - C6,3



	L mm	g	Ref.	☐
PZ2	50	12	20180	10
PZ3	50	12	20190	10

### EMBOUS POZIDRIV CLASSIC LONG 1/4 - E6,3



	L mm	g	Ref.	☐
PZ1	50	11,5	23110	10
PZ2	50	12	23120	10
PZ2	70	16	23150	10
PZ3	50	12	23130	10



## EMBOUTS TORX

### ORIGINE

- C'est en 1967 dans l'aéronautique que naît la vis Torx.  
Torx, Resistorx et Torx Plus sont des marques déposées de Textron, Inc.

### PARTICULARITÉS

- Forme étoile à 6 lobes
- Excellente tenue au vissage
- Très appréciée de professionnels, elle a conquis le marché tant dans l'industrie que dans le bâtiment.
- ISO 10664

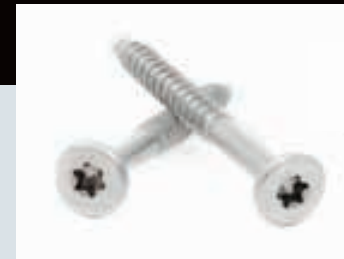

### EMBOUT TORX CLASSIC 1/4 - C6,3



	L mm	g	Ref.	☐
T10	25	5	20840	10
T15	25	5	20850	10
T20	25	5	20860	10
T25	25	5,5	20870	10
T30	25	6	20890	10
T40	25	6	20900	10

### EMBOUT TAMPER TORX CLASSIC 1/4 - C6,3



	L mm	g	Ref.	☐
TT10	25	5	21840	10
TT15	25	5	21850	10
TT20	25	5	21860	10
TT25	25	5,5	21870	10
TT30	25	6	21890	10
TT40	25	6	21900	10

### EMBOUT TORX TIN 1/4 - C6,3



	L mm	g	Ref.	☐
T10	25	5	22340	10
T15	25	5	22350	10
T20	25	5	22360	10
T25	25	5,5	22370	10
T30	25	6	22390	10
T40	25	6	22400	10

### EMBOUT TORX CLASSIC LONG 1/4 - E6,3



	L mm	g	Ref.	☐
T10	50	10,5	23840	10
T15	50	11	23850	10
T20	50	11	23860	10
T25	50	11,5	23870	10
T30	50	12	23890	10
T40	50	12	23900	10



16



62



96



120



126



156



188



224



248



254



300



316



340



390



462



488



# EMBOUS DE VISSAGE



## EMBOUS HEXAGONAL

### ORIGINE

- Suite à l'invention en 1907 de l'empreinte carrée par Robertson, de nombreuses sociétés ont mis au point une version 6 pans encore plus performante : Allen en 1910 aux Etats-Unis, BTR en France ou encore Inbus en Allemagne en 1936.

### PARTICULARITÉS

- Empreinte hexagonale 6 pans
- Avantages : six surfaces de contact entre la tête de la vis et la clé. D'autre part, la vis tient sur l'embout et peut être placée dans son logement.
- Inconvénient : il devient difficile d'introduire l'embout lorsque la cavité est obstruée par de la rouille ou de la peinture.
- Utilisée en agencement et en construction mécanique.
- ISO 4762 Din 912 / NF E 25.125



### EMBOUS HEXAGONAL CLASSIC 1/4 - C6,3



	L mm	▲ g	Ref.	☐
H2,0	25	5	20610	10
H3,0	25	5	20630	10
H4,0	25	5	20640	10
H5,0	25	5,5	20650	10
H6,0	25	6,5	20660	10
H7,0	25	7,5	20690	10
H8,0	25	7,5	20670	10



## EMBOUS SPANNER

### ORIGINE

- Empreinte récente développée pour rendre des assemblages inviolables.

### PARTICULARITÉS

- Forme Snake-eyes « œil de serpent »
- Vis de sécurité : impossible de la dévisser sans l'embout adéquat.
- Elle empêche un serrage trop puissant de la vis car il existe une forte contrainte d'entaillage (l'embout peut vriller si on serre trop fort)

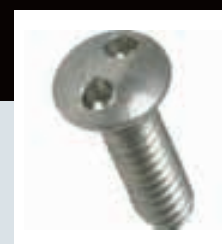

### EMBOUS SPANNER CLASSIC 1/4 - C6,3



	L mm	▲ g	Ref.	☐
4	25	5	26550	10
6	25	6	26570	10
8	25	7,5	26580	10
10	25	9,5	26590	10



## EMBOUTS DOUILLE

### DOUILLE MAGNÉTIQUE

- Embout fortement aimanté : par exemple, une vis de Ø 12,0 x 400 mm reste fixée sur l'embout magnétique quelle que soit sa position.
- Carré d'entraînement E63 à gorge pour une meilleure tenue.



### EMBOUT DOUILLE MAGNETIQUE 1/4 - E6,3



	L mm	g	Ref.	Q
7	50	24,5	27850	10
8	50	26,5	27860	10
10	50	30	27870	10
11	50	45	27960	10
13	45	50	27950	10



## EMBOUTS RÉVERSIBLES FENTE

### RÉVERSIBILITÉ

- Dits également « Double Ended Bit », ces embouts réversibles permettent de gagner en compacité : 2 empreintes par embout.
- Le corps sert de carré d'entraînement C6,3
- Longueur 50 mm



### EMBOUT REVERSIBLE FENTE - PH CLASSIC 1/4 - C6,3



	L mm	g	Ref.	Q
0,6x4,5 - PH1	50	9,5	26010	10
0,8x5,5 - PH2	50	10	26020	10
1,0x7,0 - PH3	50	11	26030	10



16



62



96



120



126



156



188



224



248



254



300



316



340



390



462



488



# EMBOUS DE VISSAGE



## EMBOUS DE VISSAGE S2

### QUALITÉ

- Qualité d'embout : acier au Silicium S2, supérieur à l'acier Chrome Vanadium.
- Très bonne précision dimensionnelle.
- Présentation en boîtes de 10.



### BOÎTE D'EMBOUS - FENTE



Dim. x Q par boîte	L mm	g	Ref.	☐
0,5x4mm x10	25	55	919A541401	1
0,6x4mm x10	25	55	919A641401	1
0,8x5,5mm x10	25	60	919A081401	1
1x5,5mm x10	25	60	919A101401	1
1,2x6,5mm x10	25	60	919A121401	1
1,2x8mm x8	25	60	919A131401	1

### BOÎTE D'EMBOUS - PHILLIPS



Dim. x Q par boîte	L mm	g	Ref.	☐
PH1 x10	25	55	919B011401	1
PH2 x10	25	55	919B021401	1
PH3 x10	25	60	919B031401	1
PH4 x3	25	20	919B041401	1

### BOÎTE D'EMBOUS - POZIDRIV



Dim. x Q par boîte	L mm	g	Ref.	☐
PZ1 x10	25	55	919C011401	1
PZ2 x10	25	60	919C021401	1
PZ3 x10	25	60	919C031401	1
PZ4 x3	25	25	919C041401	1

### BOÎTE DE 10 EMBOUS - TORX

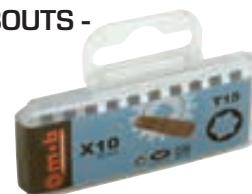

Type	L mm	Qté par boîte	g	Ref.	☐
T6	25	10	50	919D061401	1
T7	25	10	50	919D071401	1
T8	25	10	50	919D081401	1
T9	25	10	50	919D091401	1
T10	25	10	55	919D101401	1
T15	25	10	55	919D151401	1
T20	25	10	55	919D201401	1
T25	25	10	60	919D251401	1
T27	25	10	60	919D271401	1
T30	25	10	65	919D301401	1

### BOÎTE DE 10 EMBOUS - TAMPER TORX

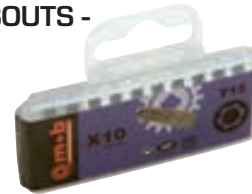

Type	L mm	Qté par boîte	g	Ref.	☐
TT8	25	10	52	919G081401	1
TT10	25	10	55	919G101401	1
TT15	25	10	55	919G151401	1
TT20	25	10	55	919G201401	1
TT25	25	10	60	919G251401	1
TT27	25	10	60	919G271401	1
TT30	25	10	60	919G301401	1
TT40	25	10	65	919G401401	1

### BOÎTE D'EMBOUS - HEXAGONAL



Dim. x Q par boîte	L mm	g	Ref.	☐
H2,0 x10	25	50	919E021401	1
H2,5 x10	25	55	919E251401	1
H3 x10	25	55	919E031401	1
H4 x10	25	60	919E041401	1
H5 x10	25	65	919E051401	1
H6 x10	25	70	919E061401	1
H7 x8	25	65	919E071401	1
H8 x7	25	65	919E081401	1
H10 x3	25	35	919E101401	1





## BOÎTE DE 10 EMBOUTS - CARRE

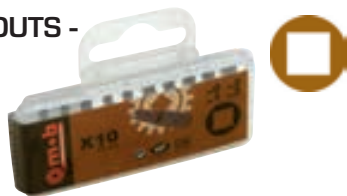

Contenu	L mm	Qté par boîte	g	Ref.	📦
2xC0 - 3xC1 - 3xC2 - 2xC3	25	10	55	919F991401	1

## BOÎTE DE 10 EMBOUTS - SPANNER



Contenu	L mm	Qté par boîte	g	Ref.	📦
2xS4 - 3xS6 - 3xS8 - 2xS10	25	10	55	919I991401	1

## BOÎTE DE 10 EMBOUTS - TRI-WING



Contenu	L mm	Qté par boîte	g	Ref.	📦
2xTW2 - 3xTW3 - 3xTW4 - 2xTW5	25	10	60	919J991401	1

## BOÎTE DE 10 EMBOUTS - TORQ-SET (FOUR-WING)



Contenu	L mm	Qté par boîte	g	Ref.	📦
2x N°4 - 2x N°5 - 2x N°6 - 2x N°8 - 2x N°10	25	10	60	919K991401	1
10 x N°0	25	10	20	919K001401	1
10 x N°1	25	10	35	919K011401	1
10 x N°2	25	10	50	919K021401	1
10 x N°3	25	10	60	919K031401	1
10 x N°4	25	10	60	919K041401	1
10 x N°5	25	10	65	919K051401	1
10 x N°6	25	10	70	919K061401	1
10 x N°8	25	10	75	919K081401	1
10 x N°10	25	10	80	919K101401	1

## EMBOUT PORTE-DOUILLE



L mm	g	Ref.	📦
25	5	919Z000010	5

## TOURNEVIS PORTE-EMBOUT

Magnétique - manche bi-matière.



L mm	l1 mm	ØDa mm	ØDb mm	Lu mm	g	Ref.	📦	Ref.	📦
210	100	10	33	10	100	9283200101	1	9283201101	1

## TOURNEVIS PORTE-EMBOUT A VERROUILLAGE

Magnétique système Autolock - manche bi-matière.



L mm	L1 mm	ØDa mm	ØDb mm	Lu mm	g	Ref.	📦
160	42	14,2	38	11,8	100	9283150001	1



## PORTE-EMBOUT AUTOLOCK

### AUTOLOCK

- Verrouillage rapide par clipsage de l'embout
- Déverrouillage et éjection de l'embout par déplacement de la bague



- Aimant permanent
- Corps monobloc
- Très bonne précision dimensionnelle.

## PORTE EMBOUT MAGNÉTIQUE AUTOLOCK

AutoLock : verrouillage rapide par clipsage de l'embout - déverrouillage et éjection de l'embout par déplacement de la bague - aimant permanent puissant - corps monobloc.



L mm	Ø1 mm	Ø2 mm	g	Ref.	📦
60	14	11	30	9460000210	1

## PORTE EMBOUT MAGNÉTIQUE

Bague acier inoxydable - aimant permanent puissant - verrouillage et déverrouillage de l'embout par déplacement de la bague.



L mm	Ø1 mm	Ø2 mm	g	Ref.	📦
60	14	10	30	9460000110	1

## PORTE-EMBOUT MAGNÉTIQUE BITLOC PRO

Bague acier inoxydable, système Quick release - aimant permanent.



L mm	Ø mm	g	Ref.	📦
62	12,5 + Magnet	27	37380	1



16



62



96



120



126



156



188



224



248



254



300



316



340



390



462



488

151



# POIGNÉES ET ACCESSOIRES



## POIGNÉE SPIN POWER



Spin Power est une poignée porte-douilles ultra rapide et puissante, alternative au cliquet. Son principe : une poignée aluminium rotative, elle reste dans la main pendant que la tige tourne.

### RAPIDE

En phase de serrage/desserrage rapide : la clé en T tourne extrêmement vite, sans friction.

### PUISSANT

En phase de serrage puissant: une main serre puissamment pendant que l'autre maintient l'ensemble avec précision.

### CONFORTABLE

3 positions de la poignée possibles grâce à la bague poussoir pour un guidage ajusté.

## POIGNÉE SPINPOWER PORTE-EMBOUT



Porte-embout magnétique.



L mm	Ø1 mm	Ø2 mm	Ø3 mm	l mm	L1 mm	g	Ref.	1
325	9.3	19.5	12.5	142.5	102	310	9135311001	1



## TOURNEVIS RÉVOLVER PORTE-EMBOUTS À CLIQUET

### CLIQUET PROFESSIONNEL

Angle de reprise de 8° (46 dents).  
3 positions (vissage, dévissage, blocage) sélectionnables à une main.



### LAME À PORTE-EMBOUT MAGNÉTIQUE

Nickelée-chromée. Moletée pour les approches rapides.



### MANCHE ERGONOMIQUE BIMATIÈRE À RÉSERVOIR DÉVISSABLE

Les embouts et la lame se rangent au besoin dans le manche pour une compacité maximum.



## POIGNÉE RÉVOLVER À CLIQUET + EMBOUTS



4 - 5	PH1 - PH2 - PH3	PZ1 - PZ2
-------	-----------------	-----------



L mm	l1 mm	l2 mm	g	Ref.	1
168	38	135	335	9462099001	1



## POIGNÉE POUR EMBOUTS DE PRÉCISION

### POIGNÉE DOUBLE

La poignée accueille 2 types d'embouts grâce à la bague de conversion.



### ACCESSIBILITÉ

Grande accessibilité dans les espaces réduits grâce aux 2 rallonges.

L'arrière du tournevis en ABS tourne librement pour permettre d'appuyer pendant le vissage, avec l'index, la paume ou la base de l'index.



### COFFRET EMBOUTS PRÉCISION SCHRÖDER

- Micro et 1/4 - Vissage fin :
  - 1 poignée aluminium.
  - 2 rallonges porte-embouts : pour embouts micro et embouts carré 1/4.
  - 45 embouts de vissage Schröder :
    - 30 embouts micro
    - 15 embouts 1/4"

Produit en fin de vie.



+ 2 rallonges	T3 - T4 - T5 - T6 - T7 - T8 - T9 - T10 - T15 - T20	PZ1 - PZ2 - PZ3
0,8 - 1,2 - 1,5 - 1,8 - 2 - 2,5 - 3 - 3,5 mm	H0,7 - H0,9 - H1,3 - H1,5 - H2 - H2,5 - H3 - H4	T25 - T27 - T30 - T40
PH000 - PH00 - PH0 - PH1	4 - 4,5 - 5,5 - 6 - 6,5 mm	H5 - H6 - H8

Contenu		g	Ref.	
48 pcs	136x272x36	250	9460048001	1

### COFFRET EMBOUTS PRÉCISION

- Dans coffret Compact
  - 1 poignée aluminium.
  - 1 rallonge porte-embouts micro.
  - 1 rallonge porte-embouts carré 1/4.
  - 20 embouts micro.
  - 10 embouts carré 1/4".



+ 2 rallonges	T5 - T6 - T7 - T8 - T9 - T10 - T20	PH2
0,8 - 1,5 - 2 - 3 - 3,5 mm	H1,5 - H2 - H2,5 - H3 - H4	PZ1 - PZ2
PH00 - PH0 - PH1	4 - 5,5 mm	T25 - T30
		H5 - H6 - H8

Contenu	g	Ref.	
33 pcs	290	9460033001	1



- 16
- 62
- 96
- 120
- 126
- 156
- 188
- 224
- 248
- 254
- 300
- 316
- 340
- 390
- 462
- 488



# JEUX D'EMBOUTS



## MINI CLIQUET ROND 1/4"

➔ IDÉAL DANS LES ZONES DIFFICILES D'ACCÈS

- Longueur : 80mm
- 3 positions : fixe, serrage, desserrage
- Angle de reprise de 10°
- Compatible avec embouts ou douilles grâce au porte-douilles.



## COFFRET MINI CLIQUET SCHRÖDER

8 douilles 6 pans :  
7/8/9/10/11/12/13/14  
// 1 cliquet compact  
porte-embouts //  
1 porte-embouts  
magnétique Autolock //  
1 embout porte-douilles  
1/4 // 24 embouts  
Schröder.



Produit en fin de vie.

	9210 7- 8- 9- 10- 11- 12- 13- 14 mm		9460 Autolock		919B PH1 - PH2 - PH3
	919Z Embout porte- douille		919C PZ1 - PZ2 - PZ3		919E H2 - H2,5 - H3 - H4 - H5 - H6 - H8
	919A 4x0,5 - 4,5x0,6 - 5,5x0,8 - 6x1,2		919D T10 - T15 - T20 - T25 - T27 - T30 - T40		919A 4x0,5 - 4,5x0,6 - 5,5x0,8 - 6x1,2

Contenu	Dim.	g	Ref.	📦
35 pcs	136x272x36	510	9460035001	1

## JEU DE 12 EMBOUTS TORX CLASSIC SCHRÖDER



Dim. mm	Contenu	g	Ref.	📦
T10 T15x2 T20x3 T25x3 T30x2 T40	12 pcs	80	36101	1

## JEU DE 21 PCS EMBOUTS CLASSIC SCHRÖDER



Dim.	Contenu	g	Ref.	📦
PH1 PH2x2 PH3 PZ1 PZ2x2 PZ3 TORX T10 T15 T20x2 T25x2 T27 T30 T40 HEXA H4 H5 H6	21 pcs	210	39321	1

## TROUSSE D'EMBOUTS DE VISSAGE 29 PIÈCES SCHRÖDER

Trousse textile 600 deniers, avec passant pour ceinture, ouverte L340mm.

- 1 poignée Comforce Protorg, orientable à cliquet.
  - 1 porte embouts magnétique.
  - 27 embouts.
- Produit en fin de vie.



	Comforce Protorg 3703		236 50mm - H3-H4- H5-H6		238 HiCrom 50mm - T10-T15-T20-T25- T27-T30-T40
	232 50mm - 4,5-5,5-6,5		230 HiCrom 50mm - PH1-PH2x2-PH3		283 PHZ1 - PHZ2 - PHZ3
	231 HiCrom 50mm - PZ1x2-PZ2x2- PZ3x2				

Contenu	Dim.	g	Ref.	📦
29	135x215x60	585	9588030010	1

## BOÎTE 30 EMBOUTS + PORTE EMBOUT

Embouts qualité S2



	919A 4x0,5 - 4,5x0,6 - 5,5x0,8 - 5,5x1 - 6,5x1,2		919C PZ0 - PZ1 - PZ2 - PZ3		919D T7 - T8 - T9 - T10 - T15 - T20 - T25 - T27 - T30 - T40
	919B PH0 - PH1 - PH2 - PH3		919E H2 - H2,5 - H3 - H4 - H5 - H5,5 - H6		9460 porte-embout

g	Ref.	📦
250	9460030010	1



## BOÎTIER 32 EMBOUITS

### PRATIQUE

- Ouverture à 100 %
- Grande accessibilité et visibilité des embouts.
- Le boîtier tient dans la poche et s'accroche à la ceinture.



- embouts 25 mm
- acier au Silicium S2
- repérage facilité grâce au ressort de couleur

1 porte embout magnétique autolock 60 mm



## BOÎTIER 32 EMBOUITS DE VISSAGE + PORTE EMBOUT

Embouts qualité S2 avec bague couleur.



	919A 4x0,5 - 4,5x0,6 - 5,5x0,8 - 6,5x1,2 - 8x1,2
	919B PH0 - PH1 - PH2 - PH3

	919C PZ0 - 3xPZ1 - 3xPZ2 - PZ3
	919E H1,5 - H2 - H2,5 - H3 - H4 - H5 - H6 - H8

	919D T10 - T15 - T20 - T25 - T27 - T30 - T40
	9460 Autolock

g	Ref.	Ref.
250	9461000001	9461001001

## COFFRET D'EMBOUITS DE VISSAGE BOX 115 PIÈCES

- 1 poignée tournevis.
- 1 porte-outils magnétique.
- 1 douille porte-embouts.
- 112 embouts.



	9283 Nertech
	9460 Autolock
	929A
	919A 3,5-4-4,5-5,5x2- 6,5-8 mm

	919B PH0x2-PH1x5- PH2x10-PH3x2- PH4
	919C PZ0-PZ1x5- PZ2x11-PZ3x2- PZ4
	919D T6-T7-T8-T9- T10x2-T15x2- T20x8-T25x2-T27- T30x3-T40x2-T50
	919G TT10-TT15-TT20- TT30-TT40

	919E H1,5x2-H2x2- H2,5x2-H3x2- H4x3- H5x3- H6x2- H7-H8x2-H10
	919F 0 - 1 - 2 - 3
	919I 4 - 6 - 8 - 10
	919J 2 - 3 - 4
	919K 5 - 6 - 8 - 10

Dimensions mm	g	Ref.
115 pcs	135x215x60	1020
		9416107001

## BOX COMFORCE ET EMBOUITS SCHRÖDER

- 1 poignée ComForce Protorq Schröder orientable à cliquet.
- 1 rallonge 150 mm.
- 1 douille porte-embouts.
- 10 douilles 1/4" 6 pans : 4/5/6/7/8/9/10/11/12/13 mm.
- 20 embouts Schröder de qualité supérieure 73MoV52 :
  - 4 Fentes : 3/4,5/5,5/6,5
  - 3 Phillips : PH1/PH2/PH3
  - 3 Pozidriv : PZ1/PZ2/PZ3
  - 5 Torx : T10/T15/T20/T25/T27
  - 5 Hexagonaux : H2-H3-H4-H5-H6.



Produit en fin de vie.

	Comforce Pro- torq + rallonge 150 mm
	4-5-6-7-8-9- 10-11-12-13 mm

	PH1 - PH2 - PH3
	3 - 4,5 - 5,5 - 6,5 mm

	PZ1 - PZ2 - PZ3
	T10 - T15 - T20 - T25 - T27
	H2 - H3 - H4 - H5 - H6
	Rallonge

Contenu	Dimensions mm	g	Ref.
33 pcs	135x215x60	800	9416033001





  
**mob**  
9306-22

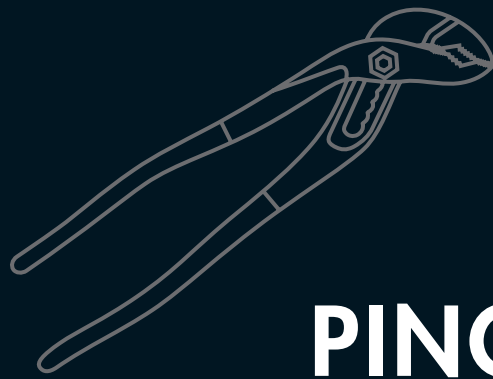

# 006

## PINCES, CISAILLES ET COUPE-BOULONS

**P.158**

**| PINCES BIMATIÈRE**



**P.168**

**| PINCES MULTIPRISES**



**P.178**

**| COUPE-BOULONS**



**P.162**

**| PINCES MONOMATIÈRE**



**P.172**

**| PINCES À CIRCLIPS**



**P.182**

**| PINCE À RIVETER**



**P.164**

**| PINCES ISOLÉES 1000 V**



**P.174**

**| PINCES ÉTAUX**



**P.183**

**| PINCES ÉLECTRICITÉ**



**P.166**

**| PINCES DE PRÉCISION  
MICRO**



**P.177**

**| TENAILLES**



**P.186**

**| CISAILLES**





# PINCES MANCHE BIMATIÈRE



## LES PINCES MOB

## PREMIUM

### GAMME

#### PINCES BIMAT' PREMIUM

Pincas manchons bimatière, têtes chromées. Acier Chrome Molybdène et axe déporté (high leverage) pour les pincas coupantes.

#### PINCES MONOMAT' PREMIUM

Pincas manchons PVC, têtes polies. Compacité et maniabilité supérieures, encombrement inférieur.

#### PINCES ISOLÉES 1000V

Pincas manchons isolés, têtes chromées. Certifiées VDE-GS. Acier Chrome Molybdène et axe déporté (high leverage) pour les pincas coupantes.



### COUPE

Toutes les pincas coupantes présentent un axe déporté pour un effet de levier maximal, dit HIGH LEVERAGE

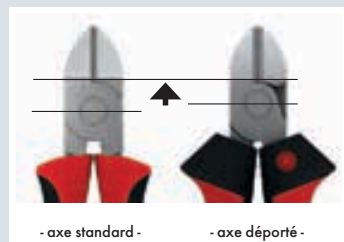

### EFFET DE LEVIER = MEILLEURE PERFORMANCE DE COUPE

Pour une meilleure performance de coupe, l'axe de l'articulation est remonté au plus près du taillant. Présent sur la pince coupante diagonale, universelle, bec demi-rond et bec demi-rond coudé



### PERFORMANCE DES TAILLANTS = PERFORMANCE ET LONGÉVITÉ DE LA PINCE

Pour que les taillants soient à la fois performants et durables, 3 points sont nécessaires :

- 1- une qualité d'acier supérieure : le Chrome Molybdène, alliage réputé pour ses qualités mécaniques élevées, et en particulier sa ténacité
- 2- une trempe des taillants pour une plus longue durée de vie
- 3- une géométrie des taillants optimale

### GÉOMÉTRIE = EFFORT DE COUPE MINIMAL

Les taillants présentent un angle étudié, ni trop fin pour une durée de vie plus longue, ni trop obtus, pour un effort de coupe minimal. C'est cette optimisation qui est réalisée sur la nouvelle pince coupante MOB

### CAPACITÉS

Les pincas coupantes sont conçues pour couper tout type de fils et feuillards : feuillards, acier ou nylon, Ertalon, Nylatron, fils de cuivre, bronze, dur, mi-dur ou même corde à piano.





# PINCES MANCHE BIMATIÈRE



## PINCES MANCHE BIMATIÈRE, TÊTE CHROMÉE

**ERGONOMIE**  
4 points d'innovation sur le manche :

### 1 UNE GARDE MARQUÉE POUR UN MAINTIEN AMÉLIORÉ

La garde a 3 fonctions :

- 1- lors des poussées ou tractions longitudinales, évite de serrer les manchons trop fort et soulage ainsi les muscles de la main et de l'avant-bras
- 2- évite le glissement de la main. Ne glisse pas sur la partie métallique en cas de poussée.
- 3- lors des fermetures précises, permet un guidage fin par le pouce

### 2 UNE OUVERTURE FACILE GRÂCE À UN DESIGN ADAPTÉ

L'ouverture est facilitée par une forme adaptée de l'intérieur de la pince et une matière lisse, dure et sans relief.

Pas de ressort : un choix assumé, pour plus de sécurité (la pince reste fermée)

### 3 FERMETURE PUISSANTE EN PLEINE MAIN = EFFORT MUSCULAIRE MOINDRE

Des poignées plus larges permettent une meilleure répartition de la pression à l'intérieur de la main. La matière néoprène du grip possède à la fois le confort et le coefficient de friction adapté, ni trop dur (oblige à serrer la main), ni trop souple (échauffe et génère des ampoules et de la sudation).

### 4 UNE MEILLEURE PRÉSERVATION DU CANAL CARPIEN

Le syndrome du canal carpien fait partie des TMS importants.

La zone n'est donc pas spatulée mais la longueur du manchon est augmentée et la zone du canal carpien est tout simplement évitée par un affinement de la pince au bout.

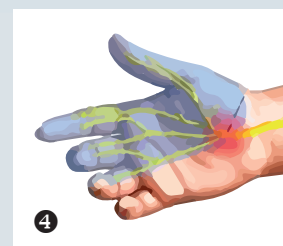
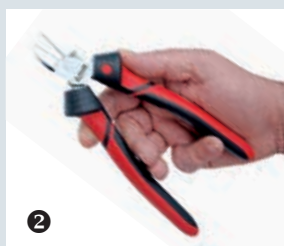

## PINCE COUPANTE DIAGONALE

NF ISO 9654/5749 -  
DIN ISO 5238 - NF E 73-105.  
Manche bi-matière.



	B mm	Lu mm	E mm	L mm	g	Ref.	☐
145	19,5	19,5	10	155	182	9305140401	1
160	21,5	22	11	175	227	9305160401	1
180	23,5	24	12	199	293	9305180401	1
200	27,5	19	12	212	311	9305200401	1

## PINCE COUPANTE DIAGONALE SUR CARTE

NF ISO 9654/5749 - DIN  
ISO 5238 - NF E 73-105.  
Manche bi-matière.



	Longueur de lame mm	L mm	g	Ref.	☐
160	22	175	227	9305161401	1
180	24	199	293	9305181401	1





# PINCES BIMATIÈRE

## PINCE COUPANTE FRONTALE

NF ISO 5348 - DIN ISO 5748.  
Manche bi-matière.



	B mm	Lu mm	E mm	L mm	g	Ref.	☐
160	31	9,5	25	174	256	9312160401	1
200	41	9,5	30	211	378	9312200401	1

## PINCE COUPANTE FRONTALE SUR CARTE

NF ISO 5348 - DIN ISO 5748.  
Manche bi-matière.



	Largueur mors mm	L mm	g	Ref.	☐
160	25	174	256	9312161401	1

## PINCE UNIVERSELLE

ISO 5746 - NF E73-103.  
Manche bi-matière.



	B mm	Lu mm	E mm	L mm	g	Ref.	☐
160	24,5	34	10,5	172	228	9304160401	1
180	25	35	11	188	274	9304180401	1
200	27	36	12,5	210	338	9304200401	1

## PINCE UNIVERSELLE SUR CARTE

ISO 5746 - NF E73-103.  
Manche ergonomique bi-matière.



	L mm	g	Ref.	☐
160	172	228	9304161401	1
180	188	274	9304181401	1

## PINCE À BECS PLATS

NF ISO 9655 - DIN ISO 5745.  
Manche bi-matière.



	B mm	Lu mm	S mm	E mm	Eb mm	L mm	g	Ref.	☐
170	18	50	3	9	9	162	167	9300170401	1

## PINCE À BECS PLATS SUR CARTE

NF ISO 9655 - DIN ISO 5745.  
Manche ergonomique bi-matière.



	L mm	Longueur becs mm	g	Ref.	☐
170	162	50	167	9300171401	1

## PINCE À BECS DEMI-RONDS

ISO 5745 - NF E 73-102.  
Manche bi-matière.



	B mm	Lu mm	S mm	E mm	L mm	g	Ref.	☐
170	18,5	52	3	9,5	165	155	9301170401	1
200	22,5	74	4	11	224	255	9301200401	1

## PINCE À BECS DEMI-RONDS SUR CARTE

ISO 5745 - NF E 73-102.  
Manche ergonomique bi-matière.



	Longueur becs mm	L mm	g	Ref.	☐
170	52	165	155	9301171401	1
200	74	224	255	9301201401	1

## PINCE À BECS DEMI-RONDS COUDÉS

NF ISO 5745.  
Manche bi-matière.



	B mm	Lu mm	S mm	E mm	L mm	g	Ref.	☐
200	22,5	71	4,5	11	220	258	9302200401	1

## PINCE À BECS DEMI-RONDS COUDÉS SUR CARTE

NF ISO 5745.  
Manche ergonomique bi-matière.



	Longueur des becs mm	L mm	g	Ref.	☐
200	71	220	258	9302201401	1



## PINCE À DÉNUDER RÉGLABLE

Manche ergonomique bi-matière.

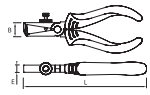

	B mm	E mm	L mm	g	Ref.	☐
160	18	9	173	190	9303160401	1

## PINCE À DÉNUDER RÉGLABLE SUR CARTE

Manche ergonomique bi-matière.



	L mm	g	Ref.	☐
160	173	190	9303161401	1

## PINCE À BECS ROUNDS

NF ISO 5745.

Manche bi-matière.

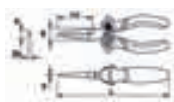

	B mm	Lu mm	S mm	E mm	Eb mm	L mm	g	Ref.	☐
170	18,5	53	4,3	9,5	2	162	161	9311170401	1

## JEU DE 4 PINCES BI-MATIÈRE

- 1 pince coupante diagonale 160 mm.
- 1 pince universelle 180 mm.
- 1 pince à becs demi-ronds 200 mm
- 1 pince multiprise à becs effilés 240 mm.



9305 160 mm	9304 180 mm	9301 200 mm	6482 240 mm
----------------	----------------	----------------	----------------

Contenu	g	Ref.	☐
4 pcs	1046	0000970501	1

## LOT DE 3 PINCES BI-MATIÈRE

- 1 pince coupante diagonale 160 mm.
- 1 pince universelle 180 mm.
- 1 pince multiprise à becs effilés 240 mm.



9305 160 mm	9304 180 mm	6482 240 mm
----------------	----------------	----------------

Contenu	g	Ref.	☐
3 pcs	800	0000989001	1

## MODULES DE 4 PINCES

- 1 pince universelle 180 mm.
- 1 pince coupante diagonale 180 mm.
- 1 pince becs plats 170 mm.
- 1 pince becs demi-ronds 170 mm.



	Contenu	g	Ref.	☐
PVC	9304-9305-9300-9301	995	9551004001	1
Bimatière	9304-9305-9300-9301	995	9551004101	1

## MODULE MOUSSE 3 PINCES

- 1 universelle 180 mm.
- 1 coupante diagonale 160 mm.
- 1 becs demi-ronds 200 mm.



Contenu	g	Ref.	☐
Ref. 9304- 9301- 9305	755	9808003001	1

## BOX MAINTENANCE (2 PINCES + 5 TOURNEVIS)

- 5 tournevis bimatière :
  - 3 fentes : 3.5x75-4x100-6,5x150
  - 2 Phillips : PH1-PH2.
- 1 pince coupante 160 mm.
- 1 pince universelle de 160 mm.
- 9 clés mâles 1,5 - 2 - 2,5 - 3 - 4 - 5 - 6 - 8 - 10 mm.



9305 160 mm	9304 160 mm	9062 1,5 - 2 - 2,5 - 3 - 4 - 5 - 6 - 8 - 10	9100 3.5x75-4x100- 6,5x150 mm	9102 PH1-PH2
----------------	----------------	--	-------------------------------------	-----------------

Contenu	Dimensions mm	g	Ref.	☐
8 pcs	405x225x60	1750	9436016001	1



16



62



96



120



126



156



188



224



248



254



300



316



340



390



462



488



161



# PINCES MANCHE PVC



## PINCES MANCHE PVC, TÊTE POLIE

### COMPACITÉ

- Les manchons PVC ont l'avantage d'être fins et procurent une légèreté et une maniabilité appréciée dans certains métiers.
- Le faible encombrement en fait un atout dans une caisse à outils.



### QUALITÉ

- Têtes en acier Chrome vanadium forgées et trempées
- Les parties métalliques sont partiellement polies. Ainsi, la lumière directe d'un éclairage ponctuel éblouit moins.

### PINCE COUPANTE DIAGONALE

NF ISO 9654/5749 -  
DIN ISO 5238 - NF E 73-105.  
Manche PVC.



	B mm	Lu mm	E mm	L mm	g	Ref.	☐
140	19,5	19	10	142	145	9305140001	1
160	21,5	22	11	162	185	9305160001	1
180	24	24,5	12	182	240	9305180001	1
200	28	19	12	202	280	9305200001	1

### PINCE COUPANTE DIAGONALE SUR CARTE

NF ISO 9654/5749 -  
DIN ISO 5238 - NF E 73-105.  
Manche PVC.



	Longueur de lame mm	L mm	g	Ref.	☐
160	22	162	185	9305161001	1
180	24,5	182	240	9305181001	1

### PINCE COUPANTE FRONTALE

NF ISO 5348 - DIN ISO 5748.  
Manche PVC.



L mm	Lu mm	B mm	E mm	g	Ref.	☐
160	10	31	25	230	9312160001	1
200	10	42	30	350	9312200001	1

### PINCE COUPANTE FRONTALE SUR CARTE

NF ISO 5348 - DIN ISO 5748.  
Manche PVC.



L mm	E mm	g	Ref.	☐
160	25	230	9312161001	1



## PINCE UNIVERSELLE

ISO 5746 - NF E73-103.  
Manche PVC.

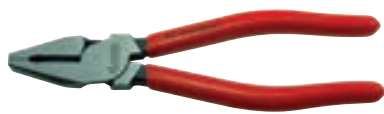
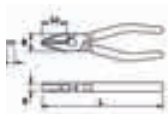

L mm	B mm	Lu mm	S mm	E mm	Eb mm	▲ g	Ref.	☐
160	23	34	6,5	10,5	10,5	200	9304160001	1
180	25	35	6	11	11	250	9304180001	1
200	27	37	7	12,5	12,5	310	9304200001	1

## PINCE UNIVERSELLE SUR CARTE

ISO 5746 - NF E73-103.  
Manche PVC.



L mm	▲ g	Ref.	☐
160	200	9304161001	1
180	250	9304181001	1

## PINCE À BECS PLATS

NF ISO 9655 - DIN ISO 5745.  
Manche PVC.

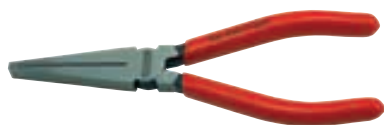
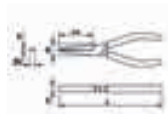

B mm	Lu mm	S mm	E mm	Eb mm	L mm	▲ g	Ref.	☐
170	17,5	51,5	3,5	9	9	160	9300170001	1

## PINCE À BECS PLATS SUR CARTE

NF ISO 9655 - DIN ISO 5745.  
Manche PVC.



Longueur becs mm	L mm	▲ g	Ref.	☐	
170	51,5	160	135	9300171001	1

## PINCE À BECS DEMI-RONDS

ISO 5745 - NF E 73-102.  
Manche PVC.

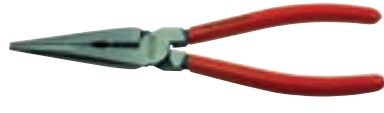

B mm	Lu mm	S mm	E mm	Eb mm	L mm	▲ g	Ref.	☐
170	18,5	51,5	3,5	9,5	3	155	9301170001	1
200	22,5	75	4,2	11	3,5	210	9301200001	1

## PINCE À BECS DEMI-RONDS SUR CARTE

ISO 5745 - NF E 73-102.  
Manche PVC.



Longueur des becs mm	L mm	▲ g	Ref.	☐	
170	51,5	155	130	9301171001	1
200	75	210	220	9301201001	1

## PINCE À BECS DEMI-RONDS COUDÉS

NF ISO 5745.  
Manche PVC.

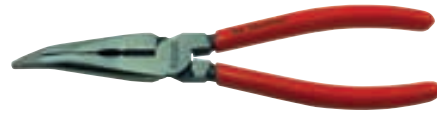

B mm	Lu mm	S mm	E mm	Ea mm	Eb mm	L mm	▲ g	Ref.	☐	
200	22,5	71	4,5	11	20	3	208	215	9302200001	1

## PINCE À BECS DEMI-RONDS COUDÉS SUR CARTE

NF ISO 5745.  
Manche PVC.



Longueur des becs mm	L mm	▲ g	Ref.	☐	
200	71	208	215	9302201001	1

## PINCE À DÉNUDER RÉGLABLE

Manche PVC.

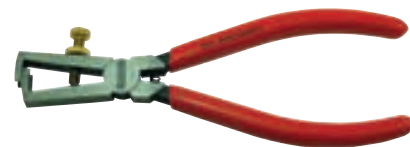
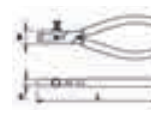

B mm	E mm	L mm	▲ g	Ref.	☐	
160	18	9	165	150	9303160001	1

## PINCE À DÉNUDER RÉGLABLE SUR CARTE

Manche PVC.



L mm	▲ g	Ref.	☐	
160	165	150	9303161001	1

## PINCE À BECS RONDS

NF ISO 5745. Manche PVC.

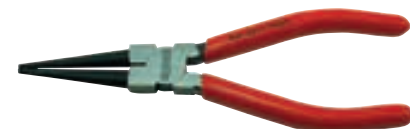
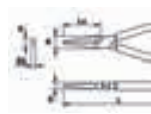

B mm	Lu mm	S mm	E mm	Eb mm	L mm	▲ g	Ref.	☐	
170	18	53	4,3	10	2	160	130	9311170001	1



16



62



96



120



126



156



188



224



248



254



300



316



340



390



462



488



# PINCES ISOLÉES 1000 V



## PINCES ISOLÉES 1000 V

### UTILISATION

- Pour tous les travaux sous tension ou à proximité d'installations sous tension (jusqu'à 1000V en courant alternatif et 1500V en courant continu).
- Gaine diélectrique bimatière pour une sécurité absolue et un plus grand confort d'utilisation.

### CONFORMITÉ

- Conforme à la norme européenne EN60900 et certifié VDE, l'organisme le plus exigeant en matière d'outils isolés.
- Chaque outil fait l'objet d'un test diélectrique unitaire à 10 000 volts pendant 10 secondes.



1000 V AC



### SÉCURITÉ ET ERGONOMIE

- La garde marquée évite le glissement de la main sur la partie métallique en cas de poussée, gage de sécurité.
- Des manchons plus larges permet une meilleure répartition de la pression à l'intérieur de la main.

### QUALITÉ DE COUPE

- Acier forgé en Chrome Molybdène.
- Parties travaillantes trempées pour une plus grande longévité.

### PINCE COUPANTE DIAGONALE

EN 60900 - VDE GS.

1000 V AC



	L mm	B mm	Lu mm	E mm	g	Ref.	☐
160	175	21,5	22	11	227	9305660401	1
180	199	23,5	24	12	293	9305680401	1
200	212	27,5	19	12	311	9305700401	1

### PINCE COUPANTE DIAGONALE SUR CARTE

EN 60900 - VDE GS.

1000 V AC

	L mm	Longueur de lame mm	g	Ref.	☐
160	175	22	227	9305661401	1
180	199	24	293	9305681401	1
200	212	19	311	9305701401	1



### PINCE UNIVERSELLE

EN 60900 - VDE GS.

1000 V AC

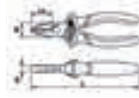

	L mm	B mm	Lu mm	E mm	g	Ref.	☐
160	172	24,5	34	10,5	228	9304660401	1
180	188	25	35	11	274	9304680401	1
200	210	27	36	12	338	9304700401	1

### PINCE UNIVERSELLE SUR CARTE

EN 60900 - VDE GS.

1000 V AC

	L mm	g	Ref.	☐
180	188	274	9304681401	1



# PINCES ISOLÉES 1000 V



## PINCE À BECS PLATS

EN 60900 - VDE GS.

1000V AC



	L mm	B mm	Lu mm	S mm	E mm	Eb mm	g	Ref.	☐
170	162	18	50	3	9	9	167	9300660401	1

## PINCE À BECS DEMI-RONDS

EN 60900 - VDE GS.

1000V AC



	L mm	B mm	Lu mm	S mm	E mm	g	Ref.	☐
200	224	22,5	74	4	11	255	9301700401	1

## PINCE À BECS DEMI-RONDS SUR CARTE

EN 60900 - VDE GS.

1000V AC



	L mm	Longueur des becs mm	g	Ref.	☐
200	224	74	255	9301701401	1

## PINCE À BECS DEMI-RONDS COUDÉS

EN 60900 - VDE GS.

1000V AC



	L mm	B mm	Lu mm	S mm	E mm	g	Ref.	☐
200	220	22,5	71	4,5	11	258	9302700401	1

## PINCE À BECS DEMI-RONDS COUDÉS SUR CARTE

EN 60900 - VDE GS.

1000V AC



	L mm	Longueur des becs mm	g	Ref.	☐
200	220	71	258	9302701401	1

## PINCE À DÉNUDER RÉGLABLE

EN 60900 - VDE GS.

1000V AC

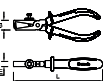

	L mm	B mm	E mm	g	Ref.	☐
160	173	18	9	190	9303660401	1

## PINCE À DÉNUDER RÉGLABLE SUR CARTE

EN 60900 - VDE GS.

1000V AC



	L mm	g	Ref.	☐
160	173	190	9303661401	1

## MULTI PACK ÉLECTRICIEN

- 3 pinces isolées 1000V :
- 1 pince coupante 160 mm
- 1 pince bec demi-rond 200 mm
- 1 pince universelle 180 mm.
- 2 tournevis isolés 1000V :
- 4x100 mm
- PZ1.



1000V AC



	9305 160 mm		9100 4x100 mm
	9304 180 mm		9103 PZ1
	9301 200 mm		

Contenu	g	Ref.	☐
5 pcs	780	0000972101	1

## MODULE DE 4 PINCES ISOLÉES 1000V

- 1 pince universelle 180 mm.
- 1 pince coupante diagonale 180 mm.
- 1 pince à becs demi-ronds 200 mm.
- 1 pince à dénuder 160 mm
- OU 1 pince à becs plats 160 mm.



1000V AC



Contenu	g	Ref.	☐
Ref. 9304-9305-9301-9300	995	9551004301	1
Ref. 9304-9305-9301-9303	1130	9551004401	1

## BOX MAINTENANCE ÉLECTRIQUE (3 PINCES + 5 TOURNEVIS ISOLÉS)

- 1 pince universelle 160 mm.
- 1 pince coupante 160 mm.
- 1 pince à dénuder 160 mm.
- 4 tournevis isolés 1000V 3,5/4/5,5/PZ1.
- 1 testeur.

1000V AC



	9305 160 mm		9100 3,5-4-5,5 mm
	9304 160 mm		9103 PZ1
	9303 160 mm		9100

Contenu	Dimensions mm	g	Ref.	☐
8 pcs	405x225x60	1750	9436008001	1



16



62



96



120



126



156



188



224



248



254



300



316



340



390



462



488



165



# PINCES DE PRÉCISION MICRO



## PINCES DE PRÉCISION BI-MATIÈRE

### TÊTE

- Tête fine en acier trempé.
- Structure de tête entrepassée pour éviter les jeux.

### MANCHE BI-MATIÈRE

- Polypropylène : résistance.
- Elastomère : grip antiglisse et confort.

### PRÉCISION

Ressort d'ouverture qui permet une approche contrôlée. Une gamme étudiée pour toute application exigeant de la précision : petite mécanique, électricité fine, électronique...

micro



Pince coupe à ras tête fine.



Manche bien calé dans la paume.

### PINCE COUPANTE SEMI-RASE

Manche ergonomique bi-matière.



L mm	B mm	Lu mm	E mm	▲ g	Ref.	☐
115	12	20	6	75	9365110401	1

### PINCE À BECS DEMI-RONDS EFFILÉS

Manche ergonomique bi-matière.



L mm	B mm	Lu mm	S mm	E mm	Eb mm	▲ g	Ref.	☐
150	12	60	2,5	1,5	1,5	80	9361150401	1

### PINCE COUPANTE FRONTALE

Manche ergonomique bi-matière.



L mm	B mm	Lu mm	E mm	▲ g	Ref.	☐
110	18,5	15	12,5	70	9368110401	1

### PINCE À BECS DEMI-RONDS COUDÉS

Manche ergonomique bi-matière.

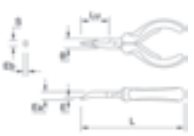

L mm	B mm	Lu mm	S mm	E mm	Ea mm	Eb mm	▲ g	Ref.	☐
125	12,5	40	2,5	6,5	10	2	84	9362120401	1

### PINCE À BECS PLATS

Manche ergonomique bi-matière.

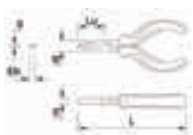

L mm	B mm	Lu mm	S mm	E mm	Eb mm	▲ g	Ref.	☐
125	12	35	2	6,5	6,5	85	9360120401	1

### PINCE À BECS RONDS

Manche ergonomique bi-matière.



L mm	B mm	Lu mm	E mm	S mm	Eb mm	▲ g	Ref.	☐
125	12,5	35	6,5	3	1,5	79	9367120401	1

### PINCE À BECS DEMI-RONDS COURTS

Manche ergonomique bi-matière.



L mm	B mm	Lu mm	S mm	E mm	Eb mm	▲ g	Ref.	☐
125	12,5	35	2,5	2	1,5	67	9361120401	1

### PINCE COUPANTE À RAS

Tête effilée.

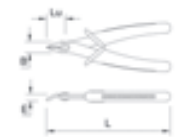

L mm	B mm	Lu mm	E mm	▲ g	Ref.	☐
130	12	20	6	62	9366130001	1



# PINCES DE PRÉCISION MICRO



## TROUSSE D'ÉLECTRICIEN

6 pinces Micro.  
Trousse zippée.  
Dimensions : 192 x 152 x 40 mm.



	9366 Pince coupante à ras		9361 Pince à becs demi-ronds courts
	9365 Pince coupante semi-rase		9362 Pince à becs demi-ronds coudés
	9368 Pince coupante frontale		9367 Pince à becs ronds

	g	Ref.	
6 pcs	615	9369060201	1

## TROUSSE DE MAINTENANCE

6 pinces Micro.  
Trousse zippée.  
Dimensions : 192 x 152 x 40 mm.



	9365 Pince coupante semi-rase		9361 Pince à becs demi-ronds effilés
	9368 Pince coupante frontale		9362 Pince à becs demi-ronds coudés
	9360 Pince à becs plats		9367 Pince à becs ronds

	g	Ref.	
6 pcs	615	9369060301	1

## TROUSSE DE PRÉCISION

9 outils Micro tournevis, pinces, brucelle.  
Trousse zippée.  
Dimensions : 192 x 115 x 35 mm.



	9366 Pince coupante à ras		9340 Brucelle arrondie		9160 1,5 - 2,0 - 2,5 mm
	9361 Pince à becs demi-ronds effilés		9162 PH00 - PH0 - PH1		

	g	Ref.	
9 pcs	390	9369090101	1

## BRUCELLE ARRONDIE



L mm	g	Ref.	
165	25	9340160001	1

## BRUCELLE ARRONDIE COUDÉE



L mm	g	Ref.	
155	25	9341150001	1

## BRUCELLE POINTUE



L mm	g	Ref.	
155	25	9342150001	1

## BRUCELLE POINTUE COUDÉE



L mm	g	Ref.	
155	25	9343150001	1



16



62



96



120



126



156



188



224



248



254



300



316



340



390



462



488



# PINCES MULTIPRISES



## PINCE MULTIPRISE SUPERPOSÉE

### TÊTE

- Tête forgée et trempée. Le traitement thermique est sélectif sur les zones travaillantes pour améliorer la durée de vie de la pince.
- Losange de prise multi-profils
- Zone crantée anti-glissement
- Usinage très fin pour une prise optimale
- Zone de prise traitée par induction pour une longévité maximale

### CARACTÉRISTIQUES

- 7 positions de réglage ouverture maximum de 55mm
- Branches PVC lavables
- Large rivet pour un guidage performant
- Distance courte entre articulation et pièce saisie : pour plus de puissance de serrage

### SÉCURITÉ

Forme des branches anti-pince doigts



### PINCE MULTIPRISE SUPERPOSÉE

NF ISO 8976 - NF E73-102.

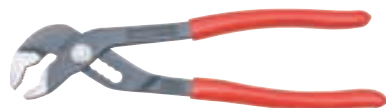
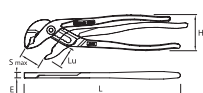

L mm	H mm	Lu mm	S max mm	E mm	g	Ref.	📦
240	55	35	55	8	310	6480240001	1

### PINCE MULTIPRISE SUPERPOSÉE SUR CARTE

NF ISO 8976 - NF E73-102.



L mm	S max mm	g	Ref.	📦
240	55	310	6480241001	1

### PINCE MULTIPRISE ENTREPASSÉE

NF ISO 8976 - NF E73-102.

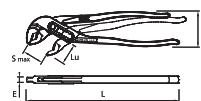

L mm	H mm	Lu mm	S max mm	E mm	g	Ref.	📦
240	55	35	33	7,5	320	6481240001	1

### PINCE MULTIPRISE ENTREPASSÉE SUR CARTE

NF ISO 8976 - NF E73-102.



L mm	S max mm	g	Ref.	📦
240	33	320	6481241001	1



## PINCE MULTIPRISE À BECS EFFILÉS

### ACCESSIBILITÉ

Becs effilés pour une prise plus précise et une meilleure accessibilité.  
Encombrement réduit des becs effilés ouverts.

### FINESSE ET RÉSISTANCE

Pièce forgée, parties travaillantes trempées.  
Capacité d'ouverture : 30 mm.

Zone de prise traitée par induction haute fréquence pour une grande résistance à l'usure et une longévité maximale. Zone crantée antiglissement.  
Table striée : améliore la prise de rondelles et prolonge la durée de vie.  
Distance courte entre articulation et pièce saisie : pour plus de puissance de serrage.

Losange de prise multi profils (rondes, carrées, hexagonales) : pas de déformation des écrous.

7 positions de réglage.



Manche BIMATIÈRE étudié pour un maximum de confort :

- Polypropylène pour plus de résistance.
- Élastomère pour une bonne prise en main.



Manche engainé anti-huile et antiglissement. Sécurité grâce à la butée anti-pince doigts.



16



62



96



120



126



156



188



224



248



254



300



316



340



390



462



488

### PINCE MULTIPRISE BIMATIÈRE BECS EFFILÉS

Superposée - finition chromée - manche bimatière.

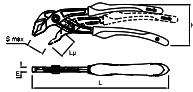

L mm	H mm	Lu mm	S max mm	E mm	g	Ref.	1
240	66	35	30	9	290	6482240401	1

### PINCE MULTIPRISE BI-MATIÈRE BECS EFFILÉS SUR CARTE

Superposée - finition chromée - manche bimatière.



L mm	S max mm	g	Ref.	1
240	30	290	6482242401	1

### PINCE MULTIPRISE À BECS EFFILÉS

Superposée - finition peinture époxy texturée - joues polies - poignées PVC expansé souple anti-graisse et anti-glisse.

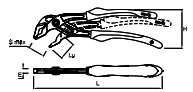

L mm	H mm	Lu mm	S max mm	E mm	g	Ref.	1
240	66	35	30	9	315	6482240001	1

### PINCE MULTIPRISE A BECS EFFILÉS SUR CARTE

Superposée - finition peinture époxy texturée - joues polies - poignées PVC expansé souple anti-graisse et anti-glisse.



L mm	S max mm	g	Ref.	1
240	30	315	6482241001	1

### PINCE MULTIPRISE ENTREPASSÉE ISOLÉE

EN 60900 - VDE GS - NF ISO 8976 - NF E73-102.

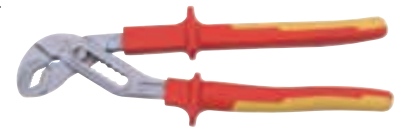
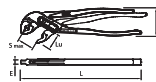

L mm	Lu mm	S max mm	E mm	H mm	g	Ref.	1
250	32,5	31,5	8	78	380	6481740401	1

### PINCE MULTIPRISE ENTREPASSÉE ISOLÉE SUR CARTE

EN 60900 - VDE GS - NF ISO 8976 - NF E73-102.



L mm	S max mm	g	Ref.	1
250	31,5	380	6481741401	1



# PINCES MULTIPRISES



## PINCE AUTOBLOQUANTE RAPIDE SANS BOUTON

### AUTOBLOQUANTE : PAS DE BOUTON À MANIPULER PRÈS DE LA TÊTE 16 POSITIONS DE RÉGLAGE

- Pour fixer l'ouverture : placer le bec supérieur sur la pièce à travailler et pousser le bras. La pince peut être posée puis reprise : le réglage est conservé. Pas besoin de multiples essais pour trouver l'écartement à 2 mains.
- Pour annuler le réglage, il suffit d'ouvrir les bras.
- Tête en acier forgé chromée. Parties travaillantes polies.
- Manche bi-matière : polypropylène pour la résistance et élastomère pour le grip.

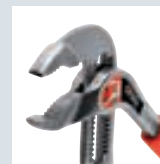

### LE PLUS : SANS BOUTON

- Réglage à même la pièce par simple action du bras supérieur.
- Pas de bouton à manipuler près de la tête
- 1/ Pratique dans les endroits difficiles d'accès
- 2/ Pour les travaux en hauteur
- 3/ Ou avec un risque de tension électrique
- 4/ Pas de risque d'accrocher le mécanisme



Ouverture maximum : 60 mm.



### PERFORMANCE

Une conception exceptionnellement robuste pour une tenue au couple inégalée. D'abord, la pince est entrepassée, c'est à dire qu'un bras passe dans l'autre. D'autre part, le mécanisme est en cage, donc protégé à l'intérieur de la pince.



### PINCE MULTIPRISE AUTOBLOQUANTE RAPIDE

Tête en acier forgé chromé  
- entrepassée.  
Manche bi-matière.



L mm	H mm	Lu mm	S max mm	E mm	g	Ref.	☐
240	48	38	60	17	375	6484240401	1

### PINCE MULTIPRISE RAPIDE AUTOBLOQUANTE SUR CARTE

Tête en acier forgé chromé  
- entrepassée.  
Manche bi-matière.



L mm	g	Ref.	☐
240	375	6484241401	3



## PINCE AUTOBLOQUANTE ZOOMER

### AUTOBLOQUANTE

Pour fixer l'ouverture : ouvrir puis serrer la pièce.  
L'ouverture est automatiquement conservée.



### PRATIQUE

- Pas de bouton à manipuler près de la tête.
- Pratique même dans les endroits difficiles d'accès.
- La pièce est plus facile à serrer, même avec une main.
- Pour annuler, il suffit d'ouvrir les bras.

### FINITION

- Manchons PVC anti-glisse, double épaisseur.
- Tête en acier forgé, phosphatée.
- Parties travaillantes polies.



### PINCE MULTIPRISE AUTOBLOQUANTE ZOOMER



L mm	S max mm	g	Ref.	☐
170 / 7"	25 mm	170	6483170001	1
240 / 10"	35 mm	355	6483240001	1
300 / 12"	40 mm	565	6483300001	1

### PRÉSENTOIR 10 PINCES MULTIPRISES ZOOMER



Contenu	L mm	g	Ref.	☐
10 pcs	240	3900	0000500301	1

### JEU DE 3 PINCES MULTIPRISES AUTOBLOQUANTES ZOOMER

170, 240, 300 mm.



Contenu	g	Ref.	☐
3 pcs	1220	6483030001	1



16



62



96



120



126



156



188



224



248



254



300



316



340



390



462



488



171



# PINCES À CIRCLIPS



## PINCES À CIRCLIPS

### ERGONOMIE

La géométrie des pincas est étudiée pour mettre en place les circlips avec une seule main.  
 Pour les pincas à circlips extérieurs, le ressort de rappel facilite la manipulation des anneaux.  
 Les pincas sont chromées et leurs branches sont gainées pour avoir une bonne prise en main.



### LES PERFORMANCES DES BECS

L'inclinaison des becs vers l'extérieur ou vers l'intérieur empêche les circlips de glisser lors des manipulations.  
 - Pour augmenter leur résistance les becs sont trempés par induction.  
 - Les diamètres des becs sont réalisés avec précision pour correspondre aux trous normalisés des circlips.



### PINCE À CIRCLIPS INTÉRIEUR À BECS DROITS

NF E 73 130 - DIN 5256.

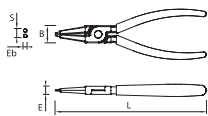

Ø mm	L mm	B mm	S mm	E mm	Eb mm	g	Ref.	☐
8-25	140	16	3,1	7,5	0,9	85	9320080001	1
19-60	182	19	5,2	9	1,8	140	9320190001	1
40-100	223	23	5,7	11	2,3	205	9320400001	1

### PINCE À CIRCLIPS INTÉRIEUR À BECS DROITS SUR CARTE

NF E 73 130 - DIN 5256.



Ø mm	L mm	Ø embouts mm	g	Ref.	☐
8-25	140	0,9	85	9320081001	1
19-60	182	1,8	140	9320191001	1

### PINCE À CIRCLIPS INTÉRIEUR BECS 90°

NF E 73 130 - DIN 5256.

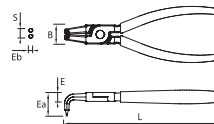

Ø mm	L mm	B mm	S mm	E mm	Ea mm	Eb mm	g	Ref.	☐
8-25	130	16	3,1	7,5	19,5	0,9	85	9321080001	1
19-60	169	19	5,2	9	23	1,8	140	9321190001	1
40-100	207	23	5,7	11	27	2,3	205	9321400001	1

### PINCE À CIRCLIPS INTÉRIEUR BECS 90° SUR CARTE

NF E 73 130 - DIN 5256.



Ø mm	L mm	E mm	Ø embouts mm	g	Ref.	☐
8-25	130	19,5	0,9	85	9321081001	1
19-60	169	23	1,8	140	9321191001	1

# PINCES À CIRCLIPS



## PINCE À CIRCLIPS EXTÉRIEUR À BECS DROITS

NF E 73 130 - DIN 5254.

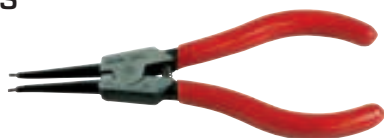
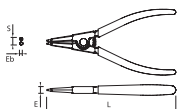

Ø mm	L mm	S mm	E mm	Eb mm	g	Ref.	1
10-25	140	4,7	7,5	1,3	95	9322100001	1
19-60	182	6,2	9	1,8	150	9322190001	1
40-100	224	7,8	11	2,3	215	9322400001	1

## PINCE À CIRCLIPS EXTÉRIEUR À BECS DROITS SUR CARTE

NF E 73 130 - DIN 5254.



Ø mm	L mm	Ø embouts mm	g	Ref.	1
10-25	140	1,3	95	9322101001	1
19-60	182	1,8	150	9322191001	1

## PINCE À CIRCLIPS EXTÉRIEUR BECS 90°

NF E 73 130 - DIN 5254.

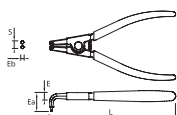

Ø mm	L mm	S mm	E mm	Ea mm	Eb mm	g	Ref.	1
10-25	130	4,7	7,5	19,5	1,3	95	9323100001	1
19-60	169	6,2	9	23	1,8	150	9323190001	1
40-100	207	7,8	11	27	2,3	215	9323400001	1

## PINCE À CIRCLIPS EXTÉRIEUR BECS 90° SUR CARTE

NF E 73 130 - DIN 5254.



Ø mm	L mm	E mm	Ø embouts mm	g	Ref.	1
10-25	130	19,5	1,3	95	9323101001	1
19-60	169	23	1,8	150	9323191001	1

## JEU DE 4 PINCES À CIRCLIPS

- 1 intérieur
- 1 intérieur 90°
- 1 extérieur
- 1 extérieur 90°



	9320 intérieur		9321 intérieur 90°
	9322 extérieur		9323 extérieur 90°

Contenu	Ø mm	g	Ref.	1
4 pcs	19-60	655	0000190001	1

## MODULE DE 4 PINCES CIRCLIPS

- 1 intérieur droit 19-60.
- 1 intérieur 90° 19-60.
- 1 extérieur droit 19-60.
- 1 extérieur 90° 19-60.



Contenu	g	Ref.	1
19-60 mm	915	9551004201	1

## MODULE MOUSSE 4 PINCES CIRCLIPS

- 1 intérieur droit 19-60.
- 1 intérieur 90° 19-60.
- 1 extérieur droit 19-60.
- 1 extérieur 90° 19-60.



Contenu	g	Ref.	1
19-60 mm	680	9809004001	1

### PINCES CIRCLIPS

Référence					Référence				
Circclips externes					Circclips internes				
OEb mm			Ø mm	d1 mm	OEb mm			Ø mm	d1 mm
NFE 22-163					NFE 22-165				
			10-13	1,5				8-9	1
1,3	9322100001	9323100001	14-17	1,7				10-11	1,2
			18-25	2	0,9	9320080001	9321080001	12-13	1,5
			19-30	2				14-17	1,7
1,8	9322190001	9323190001	32-60	2,5				18-25	2
			40-63	2,5	1,8	9320190001	9321190001	19-30	2
			65-82	3				31-60	2,5
2,3	9322400001	9323400001	85-100	3,5				40-63	2,5
					2,3	9320400001	9321400001	65-82	3
								85-100	3,5





# PINCES ÉTAUX



## PINCES ÉTAUX DE MÉCANICIEN

### PERFORMANCES DU SERRAGE

- Capacité de serrage importante réglable par crémaillère.
- Dépassement de l'axe permettant un déplacement facile.
- Mécanisme de blocage avec un mouvement souple.
- Puissance de serrage réglable par molette.
- Déverrouillage d'une seule main, sans à coups par levier arrière.



### PERFORMANCES DES MORS

- Grande résistance à l'usure grâce aux mors forgés en acier Chrome Vanadium.
- Prise puissante par une denture sur toute la profondeur du mors.
- Prise de pièces rondes facilitée en position axiale grâce à la rainure usinée du mors supérieur.
- Adaptation aux serrages de tous les profils grâce aux mors articulés avec denture droite et arrondie.

### GAMME







## PINCE ÉTAU À BECS COURTS

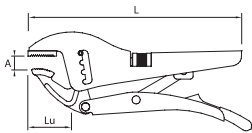

L mm	A mm	Lu mm	g	Ref.	☐
225	60	46	645	9306220001	1

## PINCE ÉTAU À BECS COURTS SUR CARTE

Capacité :  
 - cornière : 55 mm  
 - rond ou hexa. : 60 mm



L mm	g	Ref.	☐
225	645	9306221001	1

## PINCE ÉTAU À BECS LONGS

Boutonnière 5 positions.

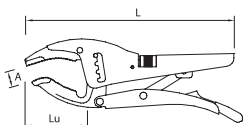

L mm	A mm	Lu mm	g	Ref.	☐
250	90	72	775	9306250001	1

## PINCE ÉTAU À BECS LONGS SUR CARTE

Capacité :  
 - cornière : 85 mm  
 - rond ou hexa. : 85 mm.



L mm	g	Ref.	☐
250	775	9306251001	1

## PINCE ÉTAU À BOUT DE BEC ARTICULÉ

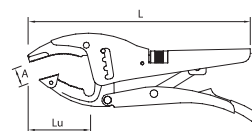

L mm	A mm	Lu mm	g	Ref.	☐
253	85	70	775	9306260001	1

## PINCE ÉTAU À BOUT DE BEC ARTICULÉ SUR CARTE

Capacité :  
 - cornière : 80 mm  
 - rond ou hexa. : 85 mm.



L mm	g	Ref.	☐
253	775	9306261001	1

## PINCE ÉTAU GRANDE CAPACITÉ 5 POSITIONS

Boutonnière 5 positions.



L mm	A mm	Lu mm	g	Ref.	☐
270	135	75	840	9306280001	1

## PINCE ÉTAU GRANDE CAPACITÉ 5 POSITIONS SUR CARTE

Boutonnière 5 positions.  
 Capacité :  
 - cornière : 60 mm  
 - rond ou hexa. : 135 mm.



L mm	g	Ref.	☐
270	850	9306281001	1



16



62



96



120



126



156



188



224



248



254



300



316



340



390



462



488

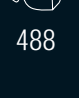

175



# PINCES ÉTAUX



## PINCES ÉTAUX AUTOMATIQUES

### PINCES ÉTAUX À SERRAGE AUTOMATIQUE

7 fois plus rapide qu'une pince étau standard.

### PRATIQUE

Verrouillage et déverrouillage d'une seule main.

Sans molette ni vis.

Les mâchoires s'ajustent automatiquement.

### AUTOMATIC



### PINCE ÉTAU AUTOMATIQUE À BECS LONGS



L mm	Ouverture mm	Ref.	📦
180-7"	42	9306051001	1

### PINCE ÉTAU AUTOMATIQUE À BECS COURTS



L mm	Ouverture mm	Ref.	📦
150-6"	40	9306061001	1
200-10"	50	9306101001	1



## PINCES ÉTAUX AXIALES POUR LA TÔLERIE

### PERFORMANCE

Compactes et légères.

Mouvement de mors rectiligne.

Déverrouillage par bouton poussoir.



### PINCE ÉTAU AXIALE POUR PIÈCES SUPERPOSÉES

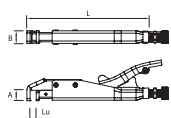

L mm	B mm	A mm	Lu mm	👤 g	Ref.	📦
180	25	13,5	16	455	9306010001	1

### PINCE ÉTAU AXIALE POUR PIÈCES ADJACENTES

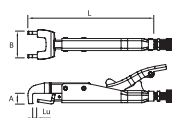

L mm	B mm	A mm	Lu mm	👤 g	Ref.	📦
190	45	21	9,5	505	9306020001	1



## TENAILLES

- **RÉSISTANCE** dureté de 50-54 HRC pour un tranchant optimum et endurant.
- **RIVET LARGE** ultra résistant
- **GRANDE PRÉCISION** polissage fin



- **RÉSISTANCE À LA CORROSION** peinture époxy rouge
- **PUISSANCE ET CONFORT** branches larges et spatulées
- **DURABILITÉ DE LA COUPE**

Les taillants des pinces mob se caractérisent par une capacité de coupe et une durée de vie importantes. Ces performances sont obtenues par la double trempe. Le traitement thermique de la pince est complété dans la zone de coupe, par une trempe par induction qui confère aux taillants une dureté exceptionnelle et donc une grande résistance à l'usure.

Une coupe puissante sans effort grâce à :

- Un usinage très précis des angles de coupe.
- Une optimisation de l'effet de bras de levier.

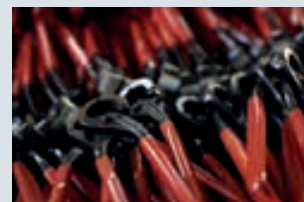

### TENAILLE RUSSE HAUTE QUALITÉ



Qualité de coupe élevée.  
Tête forgée, trempée par induction et polie.



L mm	E mm	▲ g	Ø fil de coupe (mm)	Force de coupe (N)*	Ref.	☐
200	20	220	1,6	455	6350200001	1
220	22	295	1,6	430	6350220001	1
250	24	350	1,6	415	6350250001	1
280	25	505	1,6	405	6350280001	1

### TENAILLE DE MENUISIER



Qualité de coupe élevée.  
Tête polie.



L mm	E mm	▲ g	Ref.	☐
180	22,5	350	6362180010	1
220	25	375	6362220010	1
250	28	530	6362250010	1

### TENAILLE RUSSE HAUTE QUALITÉ SUR CARTE

Qualité de coupe élevée.  
Tête forgée, trempée par induction et polie.



L mm	E mm	▲ g	Ref.	☐
200	20	220	6350201001	1
220	22	295	6350221001	1
250	24	350	6350251001	1

### TENAILLE DE MENUISIER SUR CARTE

Qualité de coupe élevée.  
Tête polie.



L mm	E mm	▲ g	Ref.	☐
220	25	375	6362221001	1
250	28	530	6362251001	1



16



62



96



120



126



156



188



224



248



254



300



316



340



390



462



488



177



# COUPE-BOULONS



## COUPE-BOULONS CLASSIQUES

### PERFORMANCE DE LA COUPE

- Coupe axiale. Capacité de coupe jusqu'à 16 mm de diamètre.
- Lames forgées indéformables.
- Acier haute résistance Chrome Vanadium Molybdène.
- Trempe sélective sur le tranchant des têtes pour une plus grande durée de vie (dureté : 56-60HRC).
- Géométrie exclusive (axe décentré sur l'extérieur) pour une plus grande ouverture. ①
- Têtes vissées pour une compacité supérieure aux boulons.
- Tôle de protection pour bloquer tout dévissage intempestif.



### QUALITÉ DE FINITION

- Peinture époxy cuite au four pour une excellente résistance, épaisseur 60 µm garantie.
- Poignées gainées élastomère pour une bonne prise en main et une amélioration de l'ergonomie.
- Bras tubulaires pour plus de légèreté.

### SIMPLICITÉ D'UTILISATION

- Réglage de l'écartement des lames simple par 1 seule vis excentrique.
- Conseil : laisser un jour entre les 2 lames pour éviter toute détérioration.
- Changement des lames simple par 2 vis.



## COUPE-BOULONS CLASSIQUES

Coupe axiale - bras tube - poignées néoprène.

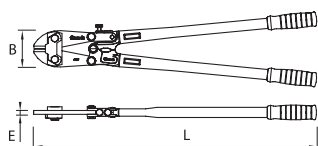

L mm	Capacité de coupe maxi 80 daN/mm <sup>2</sup>	Capacité de coupe maxi 140 daN/mm <sup>2</sup>	E mm	B mm	g	Ref.	☐
450	∅ 8 mm	∅ 6 mm	8	69	1670	0515060610	1
600	∅ 10 mm	∅ 7 mm	10	85	2375	0515070610	1
750	∅ 12 mm	∅ 9 mm	11	100	5215	0515080610	1
900	∅ 14 mm	∅ 10 mm	13	110	6480	0515090610	1
1050	∅ 16 mm	∅ 12 mm	15	128	8605	0515010001	1



## COUPE-BOULONS FORCE

### ▶ PUISSANCE

- Plus de puissance développée avec la position "coup de poing" : parfait alignement du poignet et de l'avant bras (ni hyper extension, ni rotation).



### ▶ QUALITÉ

- Lames forgées et trempées : indéformables.
- Grande durée de vie (dureté : 56-60 HRC).
- Butoir pour calage de la pièce avec tôle de protection.
- Avant bras en acier forgé.
- Bras tubulaires légers et résistants.
- Réglage rapide et facile du parallélisme des lames.
- Coupe axiale
- Coupe des aciers jusqu'à 140 daN/mm<sup>2</sup>.



## COUPE-BOULONS FORCE

Coupe axiale – bras tube – poignées étrier ergonomiques.



L mm	Capacité de coupe maxi 80 daN/mm <sup>2</sup>	Capacité de coupe maxi 140 daN/mm <sup>2</sup>	E mm	B mm	g	Ref.	☐
750	Ø 12 mm	Ø 9 mm	11	100	5850	0516080001	1
900	Ø 14 mm	Ø 10 mm	13	111	7100	0516090001	1



16



62



96



120



126



156



188



224



248



254



300



316



340



390



462



488



# COUPE-BOULONS



## COUPE-BOULONS BRAS FORGÉS

### ROBUSTESSE

Bras entièrement forgés :

- Inécrasables.
- Résistants aux conditions extrêmes des chantiers.
- Résistants aux torsions accidentelles : redressage possible.
- Grip anti-glisse et anti-froid.

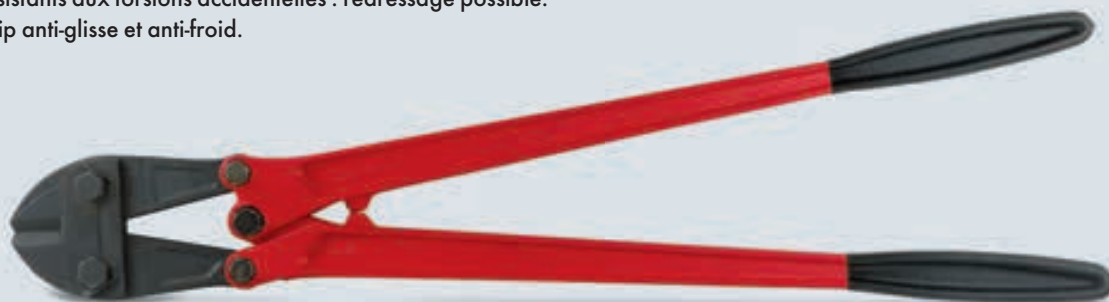

### LAMES FORGÉES ET TREMPÉES

- Indéformables.
- Grande durée de vie (dureté : 56-60 HRC).

### BUTOIR POUR CALAGE DE LA PIÈCE AVEC TÔLE DE PROTECTION

- Capacité de coupe jusqu'aux aciers de 140 daN/mm<sup>2</sup>.
- Coupe axiale.
- Réglage rapide et facile du parallélisme des lames.



### COUPE-BOULONS BRAS FORGÉS

Coupe axiale - bras forgés - poignées PVC texturé.

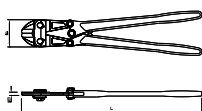

L mm	l mm	Épaisseur mm	E mm	B mm	Capacité de coupe maxi 80 daN/mm <sup>2</sup>	Capacité de coupe maxi 140 daN/mm <sup>2</sup>	g	Ref.	☐
450	115	28	8	69	Ø 8 mm	Ø 6 mm	1415	0514050610	1
600	145	33	10	85	Ø 10 mm	Ø 7 mm	2670	0514060610	1
750	185	38.5	11	100	Ø 12 mm	Ø 9 mm	4215	0514070610	1
900	210	42	13	110	Ø 14 mm	Ø 10 mm	7005	0514080610	1

### LAMES DE RECHANGE

Pour tous les coupe-boulons 0514 - 0515 - 0516.



N°	L mm	g	Ref.	☐
0	450	600	0515160610	1
1	600	975	0515170610	1
2	750	1605	0515180610	1
3	900	2130	0515190610	1
4	1050	2400	0515110001	1



## COUPE-BOULONS HAUTE QUALITÉ

### PERFORMANCE DE LA COUPE

- Adapté aux travaux intensifs de ferrailage
- Coupe axiale
- Capacité de coupe jusqu'à 16 mm de diamètre
- Lames forgées indéformables
- Acier haute résistance
- Trempe sélective sur le tranchant des têtes pour une plus grande durée de vie (dureté : 56-60HRC)



### QUALITÉ

- Poignées gainées élastomère, avec butée anti-glissement de la main
- Belle qualité de finition de la tête : polissage fin
- Bras tubulaires pour plus de légèreté, avec partie avant ovalisée pour plus de résistance

### RÉGLAGE DES LAMES

- Réglage latéral de l'écartement des lames par double point d'appui
- Conseil : laisser un jour entre les 2 lames pour éviter toute détérioration.
- Changement des lames simple par 2 vis



### COUPE-BOULONS HAUTE QUALITÉ

Coupe axiale sauf 450 :  
coupe à ras - bras tube  
- poignées néoprène -  
réglage latéral.



L mm	Epaisseur mm	Capacité de coupe maxi 80 daN/mm <sup>2</sup>	Capacité de coupe maxi 140 daN/mm <sup>2</sup>	N°	g	Ref.	☐
450	130	35	Ø 8		1670	0518045001	1
600	135	40	Ø 10	1	2375	0518060001	1
750	135	43	Ø 12	2	5215	0518075001	1
900	135	47	Ø 14	3	6480	0518090001	1
1050	170	53	Ø 16	4	9025	0518105001	1

### LAMES DE RECHANGE

Pour les coupe-boulons Haute Qualité 0518.



N°	L mm	g	Ref.	☐
0	450	600	0518145001	1
1	600	975	0518160001	1
2	750	1605	0518175001	1
3	900	2130	0518190001	1
4	1050	2400	0518205001	1

- 16
- 62
- 96
- 120
- 126
- 156
- 188
- 224
- 248
- 254
- 300
- 316
- 340
- 390
- 462
- 488



# PINCE À RIVETER



## PINCE À RIVETER

### RÉSISTANCE

Dureté des embouchures : 44HRC (+/-3)  
Dureté des pincas du mécanisme interne : 58HRC (+/-2)

### PERFORMANCE

- Pose des rivets rapide : 4 pompes pour rivets de 5 mm, 2 pompes pour rivets de 3 mm
- Bonne éjection de la tige après pose du rivet
- Embouchures sur le bras mobile pour une meilleure accessibilité
- Diamètres embouts : 2,4-3-4-4,8
- Fixation embouts : Clé placée à l'intérieur du manchon

### MODE D'EMPLOI

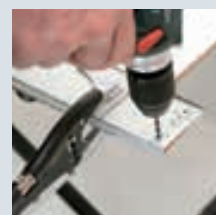

### PINCE À RIVETER

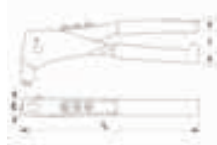

L mm	l mm	E mm	g	Ref.	📦
260	60	25	520	9350001001	1

### COFFRET PINCE À RIVETER + 500 RIVETS

Rivets corps alu - pointe acier.



9350

	Tête standard 4 x 8 mm : 100 pcs 4 x 10 mm : 100 pcs 4,8 x 8 mm : 100 pcs 4,8 x 10 mm : 100 pcs
--	---

	Tête large 4x8 mm : 50 pcs 4x10 mm : 50 pcs
--	---

Dimensions mm	g	Ref.	📦
265x220x55	2400	9350005001	1





## PINCE À DÉNUDER AUTOMATIQUE

### DÉNUDAGE

- Dénudage de 0.08 mm<sup>2</sup> à 6 mm<sup>2</sup> (AGW 28 à 10).
- Réglage facile d'accès par curseur à roulette sur le dessus.
- Longueur de dénudage réglable de 3 à 22 mm.
- Ouverture des mâchoires après relâchement de la pression : permet d'utiliser le bout de pince pour saisir la gaine.

### COUPE

- Coupe-fils incorporé :
- 1.5 mm<sup>2</sup> fil monobrin
  - 10 mm<sup>2</sup> fil multibrin.



## PINCE À DÉNUDER AUTOMATIQUE

Coupe + dénudage des fils  
- corps en nylon renforcé et sablé.



L mm	Capacité de coupe	∅ mm <sup>2</sup>	g	Ref.	∅
205	0,08-6	1,5-10	135	9331001001	1



## PINCE À SERTIR

### SERTISSAGE

Cosses pré-isolées : 1,5-2,5-6 mm<sup>2</sup>.  
Cosses nues : 1,5-2,5-6 mm<sup>2</sup>.



### CARACTÉRISTIQUES

Dénudage 0,75 à 6 mm<sup>2</sup> et coupe-fil.  
Coupe-vis de M2,6 à M5.  
Manche bimatière.



## PINCE À SERTIR

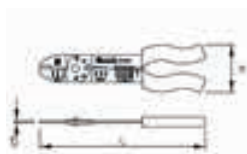

L mm	E mm	H mm	g	Ref.	∅
235	4	58	275	9330220001	1

## PINCE À SERTIR

Tôle épaisseur 4 mm.



L mm	H mm	g	Ref.	∅
235	58	275	9330221001	1

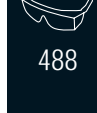
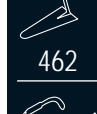
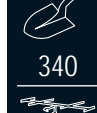
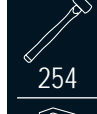
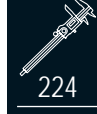
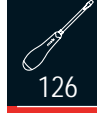
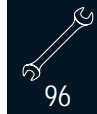



# OUTILS D'ÉLECTRICIEN

6 Pincas Cisailles Coupe-boulons

## BOÎTE DE 30 COSSES



Contenu	Ref.	
30 pcs	9603030010	1

## CLÉ UNIVERSELLE POUR ARMOIRE ÉLECTRIQUE

En zinc moulé sous pression.  
Carré 5-6-7-8-9-10 mm / Triangle 7-8-9-10-11 mm /  
Panneton double 3-5 mm / Demi-lune 6 mm.



L mm		Ref.	
95 x 95	175	92005600SB	1

## PINCE RÉVOLVER TUBE

Ø 2 à 4,5 mm - tôle d'acier polie - poignées antidérapantes - six poinçons amovibles (2,0 mm, 2,5 mm, 3 mm, 3,5 mm, 4,0 mm et 4,5 mm) - un arrêteur est prévu pour bloquer la pince une fois le poinçon choisi - une flèche indique le sens dans lequel il faut tourner la tête de cette pince.



L mm		Ref.	
240	382	8020030001	1



## COUPE-CÂBLES

### PERFORMANCES

- Dénudage et coupe de câbles de cuivre et d'aluminium.
- Lames de haute précision pour une coupe lisse et propre.
- Poignée bimatière ergonomique ou version isolées 1000V, testée unitairement.
- En acier forgé, trempé à l'huile.
- Doubles tranchants : 1<sup>ère</sup> coupe de la gaine dans la partie avant des tranchants et 2<sup>ème</sup> coupe du conducteur dans la partie arrière des tranchants.
- Capacité : diamètre max. de 25 mm.



Nota : ne convient pas aux fils d'acier, alliages d'aluminium et conducteurs de cuivre étirés à froid.

## COUPE-CÂBLES SIMPLE TRANCHANT BIMATIÈRE



L mm	B mm	E mm	Lu mm	Capacité de coupe		Ref.	
160	28	12	23	Ø 16 mm / 50 mm <sup>2</sup>	200	9371160401	1

## COUPE-CÂBLES DOUBLE TRANCHANT BIMATIÈRE



L mm	B mm	E mm	Lu mm	Capacité de coupe		Ref.	
220	28	12,5	37	Ø 25 mm / 70 mm <sup>2</sup>	315	9371210401	1

## COUPE-CÂBLES SIMPLE TRANCHANT ISOLÉ 1000V

1000V AC

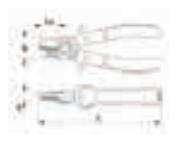

L mm	B mm	E mm	Lu mm	Capacité de coupe		Ref.	
160	28	12	23	Ø 16 mm / 50 mm <sup>2</sup>	200	9371660401	1

## COUPE-CÂBLES DOUBLE TRANCHANT ISOLÉ 1000V

1000V AC



L mm	B mm	E mm	Lu mm	Capacité de coupe		Ref.	
220	31,5	12,5	37	Ø 25 mm / 70 mm <sup>2</sup>	315	9371710401	1



## COUPE-TOUT

Grande puissance et variété de coupe : permet la coupe de plastique, feuilard, tôle fine, nylon, cuir, caoutchouc...

### PERFORMANCE

- Taillant à stries : antiglisse de tôle (évite à la tôle de se dérober pendant la coupe).
- Dureté 50-54 Hrc.
- Auto-affûtage du tranchant par croisement des lames pour un tranchant toujours au top.



### GRANDE LONGÉVITÉ

Entièrement en acier inoxydable y compris visserie et ressort.

### CONFORT D'UTILISATION

- 2 positions d'ouverture : pour petites et grandes mains.
- 1 décrochement pour couper du fil de fer ou acier cylindrique 2,5 mm.

Matière	Coupe
Cuir et carton	5 mm
Feuille de plastique	3 mm
Feuille d'aluminium	1 mm
Feuilard d'acier non trempé	0.5 mm
Fil non trempé (coupe-fil)	Ø 2.5 mm

### COUPE-TOUT DROIT

- L 210mm : 2 ouvertures grande main / petite main
- L 190 mm : sans réglage.



L mm	B mm	g	Ref.	☐
190	60	160	0361190401	1
210	70	175	0361200401	1

### COUPE-TOUT DROIT SUR CARTE



L mm	g	Ref.	☐
210	175	0361201401	1

### COUPE-TOUT COURBÉ

2 ouvertures grande main / petite main.

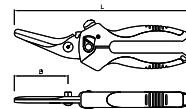

L mm	B mm	g	Ref.	☐
200	70	175	0361210401	1

### COUPE-TOUT COURBÉ SUR CARTE



L mm	g	Ref.	☐
200	175	0361211401	1



16



62



96



120



126



156



188



224



248



254



300



316



340



390



462



488



185



# CISAILLES



## CISAILLES TÔLE

### ▶ PUISSANCE ET LONGÉVITÉ

Cisailles classiques : plus de longévité.  
Cisailles forgées en une seule pièce.  
Lames arrondies. Tranchants traités par induction.  
Réaffûttables. Remontage et réglage faciles.



### ▶ TABLE ET DÉGAGEMENT DE LA MAIN

Les cisailles dites passe-tôle ou passe-franc permettent de dégager la main de la zone de travail. La table permet de guider la tôle et évite la déformation permettant une coupe continue = longue, traversante.

### ▶ LONGUEUR DES LAMES

- Lames courtes : puissance.
- Lames longues : coupe en 1 seule fois.

### CISAILLE UNIVERSELLE LAMES ÉTROITES

2 lames étroites – bec long et fin, idéal pour la coupe de feuillards, de bande en 1 seule fois – chantourneuse et à découpe – coupe à droite – tranchants traités par induction.



L mm	B mm	g	Ref.	📦
250	68	430	0361000610	1

### CISAILLE UNIVERSELLE LAME LARGE

1 lame large, 1 lame étroite – bichantourneuse et à découpe – idéale pour coupe de bande ou grillage – tranchants cémentés par induction – coupe à droite.



L mm	B mm	g	Ref.	📦
250	67	390	0361250001	1

### CISAILLE PASSE-TÔLE

Passe-tôle forme Pélican avec table permettant un dégagement de la main – pour coupe continue longue et passante – tranchants cémentés par induction.



L mm	B mm	g	Ref.	📦
300	62	730	0362000610	1

### CISAILLES CLASSIQUES

Forme avec table permettant un dégagement de la main – bichantourneuse grandes courbes coupe à droite ou à gauche – cisaille à coupe longue et continue – tranchants cémentés par induction.



L mm	B mm	g	Droite		Gauche	
			Ref.	📦	Ref.	📦
260	30	490	0521260001	1	0521260101	1
280	34	520	0521280001	1	0521280101	1

### CISAILLES TÔLE COUPE-TRU

Coupe trou – chantourneuse à droite ou à gauche : petites courbes – cisaille à découpe : coupes courtes.



L mm	B mm	g	Droite		Gauche	
			Ref.	📦	Ref.	📦
250	37	470	0522250001	1	0522250101	1



## CISAILLES À DÉMULTIPLICATION

### DÉMULTIPLICATION

- Plus de puissance, moins d'effort, comme dans un effet de levier.
- Tranchants traités masse et induction sur zone de coupe.
- Lames à micro-denture pour agripper la tôle.



### TWIST

- Le twist est la forme des lames qui permet de prendre des courbes.
- Twist important : petits rayons.
  - Twist moyen : grands rayons.
  - Twist faible ou nul : coupe droite.

### CISAILLES AVIATION BECS COURBÉS

Cisaille à découpe puissante (coupes courtes) – lames twistées : chantourneuse à droite (R) ou à gauche (L) – petits et grands rayons – tranchants avec micro-dentures – couleur normalisée : rouge à gauche et vert à droite.



L mm	B mm	g	Droite		Gauche	
			Ref.	☐	Ref.	☐
240	40	380	0524240001	1	0524240101	1

### CISAILLE AVIATION BECS DROITS

Cisaille à découpe puissante (coupe courte) – coupes courtes à droite et à gauche possibles (twist) – tranchants avec micro-denture anti-glisse de tôle pour coupe franche – poignée bimatière.



L mm	B mm	g	Ref.	☐
240	44	380	0525240101	1

### CISAILLES À DÉMULTIPLICATION

- Cisaille type passe-franc :
- forme avec table et permettant un dégagement de la main
  - double démultiplication pour une plus grande puissance de coupe
  - lames forgées, traitées
  - tranchants traités par induction
  - branches ergonomiques avec revêtement antidérapant
  - branches en acier résistant, zinguées
  - ressort d'ouverture automatique, intégré
  - pour coupes continues, droites longues et grandes courbes
  - lames à micro-dentures légères anti-glisse de tôle
  - disponible en coupe à droite (R) ou coupe à gauche (L)
  - correction de jeu des lames
  - verrouillage de sécurité.



L mm	B mm	g	Droite		Gauche	
			Ref.	☐	Ref.	☐
260	33	520	0523260001	1	0523260101	1



16



62



96



120



126



156



188



224



248



254



300



316



340



390



462



488



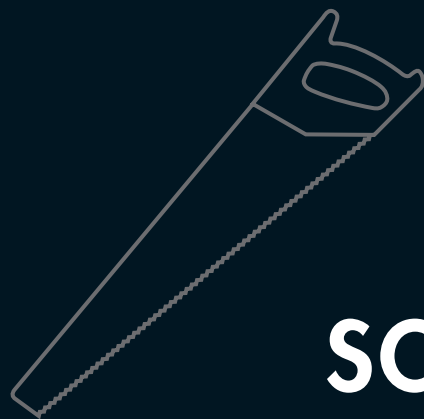

# 007

## SCIAGE, COUPE, LIMES, RÂPES

**P.190**  
| SCIES À MÉTAUX



**P.196**  
| CUTTERS



**P.215**  
| RÂPES



**P.192**  
| SCIES ÉGOÏNES



**P.198**  
| CISEAUX, COUPEAUX,  
MULTITOOL



**P.219**  
| MANCHES  
DE LIMES  
ET RÂPES



**P.194**  
| SCIES DE JARDIN

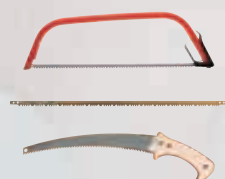

**P.202**  
| LIMES DE MÉCANIQUE



**P.217**  
| JEUX DE LIMES ET RÂPES



**P.195**  
| SCIES JAPONAISES  
TAJIMA



**P.210**  
| LIMES AIGUILLES



**P.221**  
| CISEAUX À BOIS  
MANCHE BOIS

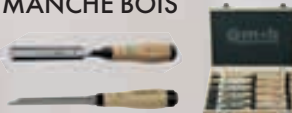

**P.212**  
| LIMES D'AFFÛTAGE



**P.223**  
| CISEAUX À BOIS  
MANCHE TRI-MATIÈRE





# SCIE À MÉTAUX



## SCIE METALCUT

### MetalCut

#### ▶ PUISSANCE ET PRÉCISION

- Résistance exceptionnelle : 190 kg, sans doute la tension la plus élevée du marché.
- Mesurée selon la norme ISO 2336 à 300 mm +/- 2 mm de distance.
- Idéale pour les travaux puissants et intenses tout en restant précis.

#### ▶ CHANGEMENT RAPIDE

- 2 positions de lame : 45° et 90°.

#### ▶ PRÉCISION

- Guidage par l'auriculaire : le plus précis car le plus proche de la coupe.
- Réglage de la tension de la lame.



#### ▶ ERGONOMIE PRÉSERVÉE

- Le levier est au-dessus de la poignée : l'ergonomie est donc totalement préservée : aucune gêne, aucun risque de mauvaise manipulation.
- Double poignée en élastomère : réduit la fatigue et augmente la performance.



#### ▶ LAME PROFESSIONNELLE

- Livrée avec une lame HSS flexible bimétal cobalt 10 dents.
- La couleur blanche unie est plus visible et ne perturbe pas le travail.



### SCIE METALCUT

Usage intensif. Levier de changement de lame.  
Tension 190 kg.

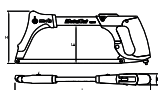

L mm	H mm	Lu mm	L mm	Lame	▲ g	Ref.	☐
405	130	100	32	300	820	6309000001	1

### SCIE À MÉTAUX ALUMINIUM

Poignée aluminium injecté.



L mm	Lame	▲ g	Ancienne Ref. Mondelin	Ref.	☐
450	300	400	833010	6369240010	1





## SCIE À MÉTAUX TUBULAIRE

Monture tubulaire.  
Manche plastique.



L mm	Lame	g	Ref.	
440	300	585	6311000010	1

## SCIE À MÉTAUX MANCHE BOIS

Monture fixe plate.  
Manche bois.



L mm	Lame	g	Ref.	
510	300	585	6310000010	1

## SCIE MONTURE COURTE

Compacte et légère.  
Idéale pour espaces difficiles d'accès.  
Manche bi-matière.



Lame	g	Ref.	
300	165	6314000001	1

## LAMES SCIE BI-MÉTAL PACK DE 5

Bi-métal HSS Cobalt - flexible.



Jeu de 5 lames				
Dents	L mm	g	Ref.	
8	300	95	6313300501	1
10	300	95	6313310501	1

## LAMES SCIE HSS 000 PACK DE 5

High Speed Steel.



Jeu de 5 lames				
Dents	L mm	g	Ref.	
8	300	95	6312300501	1
10	300	95	6312310501	1

## LAME SCIE HSS 0

High Speed Steel.



Dents	L mm	g	Ref.	
10	300	15	6313000010	10

## LAME SCIE CARBONE HCS

High Carbon Steel - pour utilisation polyvalente.



					Carte de 3	
Dents	L mm	g	Ref.		Ref.	
10	300	20	6312000010	10	6312001001	1

## LAMES SCIE BI-MÉTAL SUR CARTE

Bi-métal HSS Cobalt flexible. La couleur blanche unie est plus visible et ne perturbe pas le travail.



					Carte de 3	
Dents	L mm	g	Ref.			
10	300	75	6313310301			1

## LAMES SCIE HSS 000 SUR CARTE

High Speed Steel.  
Couleur grise.



					Carte de 3	
Dents	L mm	g	Ref.			
10	300	75	6312310301			1

## LAME SCIE HSS 0 SUR CARTE

High Speed Steel 0.



					Carte de 3	
Dents	L mm	g	Ref.			
10	300	75	6313001001			1



16



62



96



120



126



156



188



224



248



254



300



316



340



390



462



488



# SCIE ÉGOÏNE



## SCIE ÉGOÏNE NERTECHCUT II



### 2 FINESSES DE COUPE

- Scie universelle : 8 dents au pouce, pour tous travaux : planche, plan de travail aggloméré et medium, gros tasseau, bois tendre et moyen, bois brut, plâtre...
- Scie denture fine : 11 dents au pouce, pour parquet, sol mélaminé, panneau peint, plinthe, bois dur.

### LAME

- Epaisseur 1 mm, pour une très bonne tenue et une bonne transmission de l'effort
- Acier haute qualité au Chrome-Manganèse
- Vernis de protection anti-corrosion



### DENTS

- Denture diamant : 3 angles de coupe pour un meilleur mordant et une vitesse améliorée
- Avoyage une dent sur deux pour limiter les frottements dans le trait de scie



### DURÉE DE VIE

- Traitement thermique : dents trempées par induction pour une durée de vie élevée

### MANCHE

- Manche bimatière ergonomique
- 3 vis de maintien
- Angles à 90° et 45° pour aide au marquage.

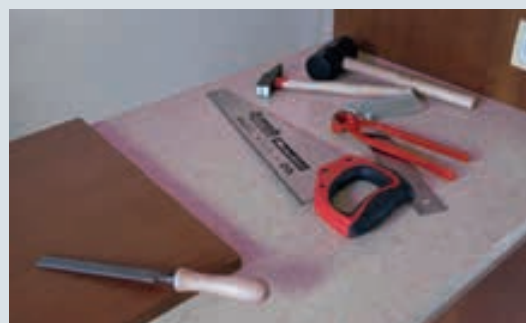

### SCIE ÉGOÏNE UNIVERSELLE NERTECHCUT II

Sciage de tous les bois et dérivés. Poignée ergonomique bi-matière. Affûtage triple biseau. Denture trempée, 8 dents au pouce. Lame épaisseur 1 mm, avec avoyage 1,5 mm.



L mm	g	Ref.	☐
400	365	6349400001	1
450	410	6349450001	1
500	445	6349500001	1
550	475	6349550001	1

### SCIE ÉGOÏNE COUPE FINE NERTECHCUT II

Sciage menuiserie y compris aggloméré. Poignée ergonomique bi-matière. Affûtage triple biseau. Denture trempée, 11 dents au pouce. Lame épaisseur 1 mm, avec avoyage 1,5 mm.



L mm	g	Ref.	☐
400	375	6348400001	1
450	415	6348450001	1
500	435	6348500001	1
550	475	6348550001	1



## SCIE ÉGOÏNE STANDARD

Poignée bi-matière. Lame épaisseur 0,8 mm, avec avoyage 1,3 mm. Denture trempée universelle 8 dents au pouce.



L mm	g	Ref.	☐
400	350	6331400001	1
450	385	6331450001	1
500	415	6331500001	1

## SCIE ÉGOÏNE DE COFFREUR NERTECHCUT II

Pour bois tendre, bois vert, charpente, coffrage. Grosse denture 3,5 TPI.



L mm	g	Ref.	☐
500	385	6305500001	2
600	445	6305600001	1

## SCIE ÉGOÏNE PLAQUE DE PLÂTRE

Denture d'attaque puis groupe de 4 dents séparé par une gorge pour une bonne évacuation de la sciure de plâtre. Lame épaisseur 0,9 mm, avec avoyage 1,3 mm. Denture trempée 6 dents au pouce.



L mm	g	Ref.	☐
400	360	6345400001	1

## SCIE À GUICHET POUR PANNEAUX DE PLÂTRE

Poignée ergonomique bimatière. Denture spéciale plâtre. Pointe effilée pour amorcer la coupe. Avec fourreau de protection. Coupe : le plâtre, le contre plaqué, le bois, le plastique.



L mm	g	Ref.	☐
150	125	6340161401	1

## SCIE À GUICHET



Poignée plastique			
L mm	g	Ref.	☐
300	110	6340300001	1

## SCIE CARBURE BÉTON CELLULAIRE

Pour coupe de matériaux type béton cellulaire, carreaux de plâtre, pierre. Denture à plaquettes au carbure de tungstène de haute qualité. 1,2 dents au pouce. Lame très rigide, épaisseur 1,6 mm, avec avoyage 3,0 mm.



L mm	g	Ref.	☐
750	870	6338700001	1

## SCIE À BÉTON CELLULAIRE

Denture trempée extra-large pour blocs de béton cellulaire, carreaux de plâtre, pierres tendres. Grosse denture 2 dents au pouce, trempée, affûtage permanent. Lame épaisseur 1,4 mm, avec avoyage 2,7 mm.



L mm	g	Ref.	☐
750	740	6337700001	1

## SCIE D'ÉBÉNISTE



Poignée bois			
L mm	g	Ref.	☐
250	160	6343250001	2

## SCIE À DOS

Pour travaux fins, ébénisterie et boîte à coupe. Denture pointue fine, trempée. 12 dents au pouce.



L mm	g	Ref.	☐
300	355	6335300001	2

## SCIE À PANNEAU

Pour la découpe de plaquage et pour attaquer la coupe en plein panneau. Denture fine trempée. 13 dents au pouce.



L mm	g	Ref.	☐
320	195	6334320001	2



16



62



96



120



126



156



188



224



248



254



300



316



340



390



462



488



# SCIE DE JARDIN

## BOÎTE À COUPE

En bois massif.

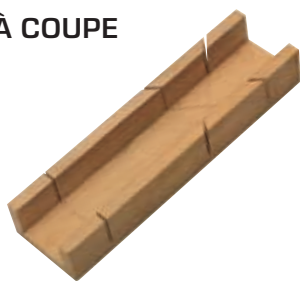

L x l cm	g	Ref.	📦
30x6	525	6325000010	2

## BOITE À COUPE FORME V

Pour toutes formes et dimensions de corniches. En bois composite.



Dimensions intérieures mm	g	Ref.	📦
550 x 150 x 190	2100	6325250101	1

## SCIE ÉGOÏNE PLAQUE DE PLÂTRE

Poignée ergonomique bi-matière. Avec denture d'amorçage (pour scie 60 cm). Lame épaisseur 0,9 mm, avec avoyage 1,3 mm. Denture trempée 6 dents au pouce, affûtage permanent. Référence Mondelin.



Longueur cm	g	Ref.	📦
60	600	831600	5
45	370	831580	1

## SCIE MÈCHE MANCHE PLASTIQUE

Avec vrille d'amorçage et denture pour découpes intérieures dans plaques de plâtre, bois, cuir, plastique.



Longueur totale cm	Longueur mèche cm	Ø mèche mm	g	Ref.	📦	Ref.	📦
27	17	5	80	832900	5	832908	1

## SCIE COUTEAU AFFÛTABLE

Pour bois brut et bois vert. Coupe en tirant.



			Poignée bois	
L mm	L lame mm	g	Ref.	📦
475	355	235	6317350010	1

## SCIE À BÛCHE L76

Affûtage permanent Hard Point. Denture américaine.



L mm	g	Ref.	📦
762	845	6301000010	2

## SCIE À BÛCHE L53

Denture isocèle.



L mm	g	Ref.	📦
533	515	6300000010	2

## LAME DE RECHANGE POUR SCIE À BÛCHE - AMERICAINE

Denture américaine trempée.



L mm	g	Ancienne Ref. Mondelin	Ref.	📦
762	75	832780	6303000010	10
533	55	832540	6304530001	10

## LAME DE RECHANGE POUR SCIE À BÛCHE - ISOCELE

Denture isocèle trempée.



L mm	g	Ancienne Ref. Mondelin	Ref.	📦
762	65	832790	6302760010	10
533	50	-	6302530010	10

## COUPE POLYSTYRÈNE ÉLECTRIQUE

Pour une découpe rapide de panneaux isolants en polystyrène. Environ 5 mètres de câble. Livré dans une mallette. Équipé de 2 lames chauffées par une résistance électrique 220 V (17 cm et 19,5 cm).



g	Ref.	📦
1930	830700	1



## SCIE TAJIMA® G SAW 240

### SCIE JAPONAISE PLIABLE

- lame repliable et facilement interchangeable
- denture polyvalente 9 TPI avec alternance de 4 grosses dents et de 4 dents plus petites. Multiplie par 3 la performance du tranchant de la lame, y compris pour le bois vert.



- Coupe en tirant.
- Grande qualité de coupe (trempe à la japonaise, à haute fréquence).
- Affûtage triple biseau.
- Epaisseur 0.9mm extra-rigide.

### SCIE TAJIMA® G SAW 240

Scie japonaise pliable. Denture universelle. Coupe en tirant. Affûtage triple biseau. Manche élastomère.



Longueur lame mm	Nb dents TPI	Epaisseur de lame mm	Ep. avec avoyage mm	Ref.	📦
240	9	0,7	1,0	832930	1

### LAME DE RECHANGE POUR SCIE TAJIMA® G SAW 240



Longueur lame mm	Nb dents TPI	Epaisseur de lame mm	Ep. avec avoyage mm	Ref.	📦
240	9	0,7	1	832931	1



## SCIE TAJIMA® RAPID PULL

### SCIE JAPONAISE COUPE FINE

- Scie de précision, coupe fine, 16 TPI.
- Utile pour couper nettement et sans éclat les liteaux, baguettes, PVC, plastique, plexi...



### CARACTÉRISTIQUES

- Coupe en tirant, 3 fois plus rapide qu'une scie traditionnelle avec un effort réduit de moitié.
- Lame facilement interchangeable.
- Grande qualité de coupe (trempe à la japonaise, à haute fréquence).

### SCIE TAJIMA® RAPID PULL

Scie japonaise coupe fine. Changement de lame rapide. Coupe en tirant. Lame facilement interchangeable. Etui carton brochant. Livrée en présentoir de 6 pièces.



Longueur lame mm	Nb dents TPI	Epaisseur de lame mm	Ep. avec avoyage mm	Ref.	📦
265	16	0,6	0,9	832820	6

### LAME DE RECHANGE POUR SCIE TAJIMA® RAPID PULL



Longueur lame mm	Nb dents TPI	Epaisseur de lame mm	Ep. avec avoyage mm	Ref.	📦
265	16	0,6	0,9	832821	1



## SCIE TAJIMA® MAGNUM SAW 300

### REVÊTEMENT FLUORINE

- Améliore la glisse
- Protège de la rouille
- Evite à la résine et à la sciure de coller.

### CARACTÉRISTIQUES

- Coupe en tirant.
- Poignée aluminium bi-matière acier et élastomère de forme enveloppante protégeant bien la main.
- Grande qualité de coupe (trempe à la japonaise, à haute fréquence).



### SCIE TAJIMA® MAGNUM SAW 300

Scie japonaise de menuisier. Revêtement fluorine. Coupe en tirant. Poignée aluminium bi-matière.



Longueur lame mm	Nb dents TPI	Epaisseur de lame mm	Ep. avec avoyage mm	Ref.	📦
300	13	0,7	1,15	832940	1



16



62



96



120



126



156



188



224



248



254



300



316



340



390



462



488



# CUTTERS TAJIMA

## CUTTERS TAJIMA

### CUTTER ALUMINIUM 18 MM TAJIMA®

Manche en aluminium, robuste et de haute qualité.  
Livré avec 2 lames.



Cutter Aluminium 18 mm Tajima®			
Epaisseur mm	g	Ref.	1
0,6	180	103498	1

### CUTTER 18 MM MANCHE ANTIDÉRAPANT TAJIMA®

Avec bouton de blocage.  
Manche élastomère antidérapant.  
Livré avec 3 lames.



Cutter 18 mm manche antidérapant Tajima®			
Epaisseur mm	g	Ref.	1
0,6	160	103528	1

### CUTTER 18 MM TAJIMA® AVEC EMBOUT DE VISSAGE

Manche antidérapant.  
Livré avec 3 lames.



Cutter 18 mm Tajima® avec embout de vissage			
Epaisseur mm	g	Ref.	1
0,6	115	103558	1



## LAMES TAJIMA® RAZAR BLACK

#### UTILISATION

- Tranchant acéré en fil de rasoir pour coupe précise et extrêmement efficace
- Idéal pour matières fines, papier, film ou autres matières de faible épaisseur ou se déchirant facilement



#### QUALITÉ TAJIMA®

- Acier SK-120 très haut de gamme pour un usinage et un affûtage fin
- Technique de trempage japonaise multi-phases qui assure une grande dureté et un affûtage longue durée
- Revêtement antifriction améliorant la résistance dans le temps

#### DISTRIBUTEUR

- Avec distributeur de lames, sans manipulation avec les doigts, pour une meilleure sécurité
- Boîte de 10 lames

### BOITE DE 10 LAMES TAJIMA® RAZAR BLACK CUTTER 18 MM

Lames «fil de rasoir» pour cutter TAJIMA®.  
Boîte de 10 lames.



Boîte de 10 lames Razar Black cutter 18 mm				
x 10	18 mm	g	Ref.	1
		99	103588	1

### BOITE DE 10 LAMES TAJIMA® CUTTER 18 MM

Lames de rechange pour cutter TAJIMA®.  
Boîte de 10 lames.



Boîte de 10 lames cutter 18 mm				
x 10	18 mm	g	Ref.	1
		90	103548	1

### CUTTER DE PLAQUISTE 25 MM TAJIMA®

Manche en aluminium, robuste et de haute qualité.  
Avec molette de blocage.  
Epaisseur : 0,7 mm.  
Livré avec 2 lames.



Cutter de plaquiste 25 mm Tajima®			
Epaisseur mm	g	Ref.	1
0,7	275	103518	1

### BOITE DE 10 LAMES TAJIMA® RAZAR BLACK CUTTER 25 MM

Lames «fil de rasoir» pour cutter TAJIMA®.  
Boîte de 10 lames.



Boîte de 10 lames Razar Black cutter 25 mm				
x 10	25 mm	g	Ref.	1
		250	103578	1

### BOITE DE 10 LAMES TAJIMA® CUTTER 25 MM

Lames de rechange pour cutter TAJIMA®.  
Boîte de 10 lames.



Boîte de 10 lames cutter 25 mm				
x 10	25 mm	g	Ref.	1
		205	103538	1

### COUPEAU ALUMINIUM LAME RETRACTABLE TAJIMA®

En aluminium peint.  
Livré avec 10 lames trapèze.



Coupeau aluminium lame retractable Tajima®			
g	Ref.	1	
225	103308	1	

### 10 LAMES TRAPÈZE TAJIMA® POUR COUPEAU

10 lames trapèze pour coupeaux



10 lames trapèze Tajima® pour coupeau			
Nb de lames	g	Ref.	1
x 10	56	103318	1

### 10 LAMES CROCHET TAJIMA® POUR COUPEAU

10 lames crochet pour coupeaux



10 lames crochet Tajima® pour coupeau			
Nb de lames	g	Ref.	1
x 10	50	103328	1



## CUTTERS MONDELIN

### CUTTER BI-MATIÈRE 18 MM

Livré avec 1 lame.  
Avec bouton de blocage.



		☰	
Epaisseur mm	g	Ref.	☐
0,6	80	103038	1

### BOITE DE 10 LAMES CUTTER 18 MM

Epaisseur 0,6 mm.  
Dimensions : 10 x 18 mm.  
Boîte de 10 lames  
avec trou de suspension.



		☰	
Nb de lames	g	Ref.	☐
x 10	75	103168	1

### CUTTER BI-MATIÈRE DE PLAQUISTE 25 MM

Spécial plaquiste. 1 lame renforcée épaisseur : 0,7 mm. Verrouillage par vis. Blocage automatique de la lame par molette de sécurité sur le guide métal. Manche bi-matière.



		☰	
Epaisseur mm	Ref.	☐	
0,7	103098	1	

### BOITE DE 10 LAMES CUTTER 25 MM

Epaisseur : 0,7 mm.  
Dimensions : 10 x 25 mm.  
Boîte de 10 avec trou  
de suspension.



		☰	
Nb de lames	g	Ref.	☐
x 10	170	103198	1

### CUTTER À LAME AUTO-RÉTRACTABLE

Avec 1 lame trapèze.  
Bi-matière. Conforme  
à la directive de  
l'inspection du travail.



		☰	
g	Ref.	☐	
75	103088	1	

### BOITE 5 LAMES TRAPÈZE

Pour cutters à lame auto-rétractable réf. 103088.



		☰	
Nb de lames	g	Ref.	☐
x 5	25	103188	1



## COUTEAU UNIVERSEL À CHARGEMENT AUTOMATIQUE

### LES PLUS

- Rechargement automatique des lames : un aller-retour de la molette permet de charger une nouvelle lame et de la faire sortir instantanément.



### PRATIQUE

- Réserve de lames accessible sans outil  
- Bouton d'éjection de la lame usagée  
- Bimatière : corps en alliage métal et zone de grip élastomère antiglisse  
- Forme galbée pour un excellent maintien dans la main  
- Trou d'accroche ou de dragonne.

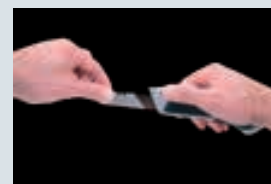

### COUTEAU UNIVERSEL

Avec 5 lames trapézoïdales dans la réserve.

		☰	
g	Ref.	☐	
265	6228001001	1	



16



62



96



120



126



156



188



224



248



254



300



316



340



390



462



488



# CUTTERS

## CUTTER PROFESSIONNEL 18MM

Avec lames 18 mm. Bimatière. Brise-lame amovible.



L lames mm	g	Ref.	Ref.
18	70	6247000010	6247001001

## ÉTUI DE 10 LAMES DE CUTTER 18 MM

Pour cutter 18 mm.



l mm	L mm	g	Ref.
18	109	40	6248001001

## CUTTER À VERROUILLAGE VIS 25MM

Idéal plaquiste. Lames sécables de 25mm. Verrouillage par vis. Construction très résistante pour coupe de plaques et matériaux épais. Grip bimatière.



L lame mm	Ref.
25 x 0,7	6244251001

## ÉTUI DE 10 LAMES DE CUTTER 25 MM

Pour cutter 25 mm.



l mm	L mm	e mm	Ref.
25	138	0,7	6245250001



## CUTTER TOPSECURITY

### INNOVATION = AUTO-RÉTRACTABLE + 2<sup>ème</sup> sécurité

Non seulement le cutter TopSecurity est auto-rétractable, c'est à dire qu'il est nécessaire de garder le bouton poussé pour que la lame sorte, mais en plus, la lame se rétracte automatiquement dès qu'elle n'est plus en contact avec le support découpé, même lorsque le bouton est encore poussé.

- Système breveté
- Conforme aux normes de sécurité TUV - GS.



30% des blessures surviennent en fin de coupe, lorsque la lame quitte le produit coupé (source : CNAMTS).

Bouton accessible sur 3 faces, pour droitier et gaucher. Bi-matière : alliage léger + élastomère

Changement rapide de la lame



## COUTEAU TOPSECURITY

Auto-rétractable + 2ème sécurité - bimatière - lame trapézoïdale.



g	Ref.	Ref.
165	6228010001	6228011001

## ÉTUI DE 10 LAMES TRAPÉZOÏDALES

Pour couteau



g	Ref.
40	6229001001

## ÉTUI DE 10 LAMES CROCHET

Pour couteau



g	Ref.
38	6229011001





## CISEAUX SOLINGEN BIMATIÈRE

### POIGNEES

- Surmoulées pour une meilleure tenue dans le temps.
- Bimatière (élastomère pour le confort et polypropylène pour la résistance).
- Poignées passe-franc permettant de dégager la main.

### LAME

- Lame micro-dentelée, évitant la glisse du matériau
- Auto-affûtable
- Longue durée de vie



Solingen

### QUALITÉ

- Fabrication à Solingen, ville du ciseau en Allemagne
- Lames en acier inoxydable trempé dans la glace (62HRC).

### PERFORMANCE

- Attaque franche : coupe dès le début.
- Performance de coupe tout au long de la lame.

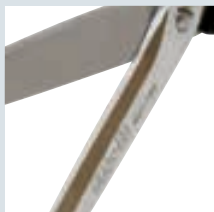
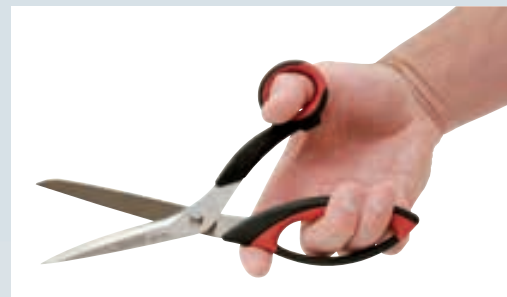

### CISEAUX D'ATELIER SOLINGEN

200 mm - 8". Inox.  
Bimatière. Vis d'ajustage.

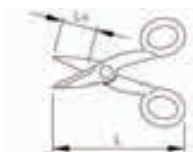

L mm	Lu mm	g	Ref.	☐
200 / 8"	80	100	6217501001	1

### CISEAUX D'ATELIER MULTI-USAGE

240 mm - 10". Acier trempé. Vis d'ajustage.

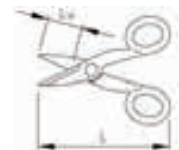

L mm	Lu mm	g	Ref.	☐
240 / 9"1/2	115	160	6217401001	1



16



62



96



120



126



156



188



224



248



254



300



316



340



390



462



488





## CISEAU D'ÉLECTRICIEN

### UTILISATION

- LE ciseau pour électricien : compact, trapu, gainé jusqu'à l'articulation



### CARACTÉRISTIQUES

- Manche bimatière
- Articulation gainée
- Lames courtes inox 40 mm
- Fonction coupe-fil
- Porte ciseaux plastique avec clip ceinture

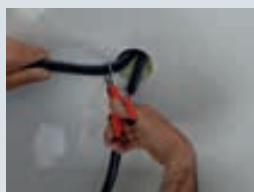

### CISEAUX D'ÉLECTRICIEN BIMATIÈRE

Manche bimatière.  
Articulation gainée.  
Lames courtes inox.  
Fonction coupe-fil.



L mm	Lu mm	g	Ref.	☐
140	40	150	6217011001	1

### CISEAUX D'ÉLECTRICIEN AVEC PORTE CISEAUX

Manche bimatière.  
Articulation gainée.  
Lames courtes inox.  
Fonction coupe-fil.  
+ Porte ciseaux



L mm	Lu mm	g	Ref.	☐
140	40	150	6217011001	1



## SET MULTI-TOOL

### OUTIL MULTITOOL

Pince universelle // Pince bec plat  
 Tournevis mécanicien 3,5 mm  
 Tournevis électricien 3mm // Tournevis PH0  
 Lime taille simple et taille double // Petite lame 2.5cm  
 Grande lame 5.2 cm //  
 Grande lame à dents (12 dents) 5.2 cm  
 Ouvreboîte



### COUTEAU

- Acier inoxydable
- Déplié : 16,5 cm / Plié : 10 cm
- Lame évidée de 6.5cm
- Clip ceinture évidé vissé



### PORTE-OUTILS TEXTILE

- Textile alvéolé doublé PVC
- Passant pour ceinture
- 2 poches avec rabat
- Fermeture scratch



### SET MULTI-TOOL

Contenu : 1 multi-tool (pince, tournevis, lames...) + 1 couteau inox + 1 poche textile avec passant de ceinture.



g	Ref.	☐
350	6202000000	1

### PINCE MULTI-TOOL SEULE

Pince multitool (pince, tournevis, lames...) + 1 poche textile avec passant de ceinture.



g	Ref.	☐
245	0000975901	1



## COUTEAU D'ÉLECTRICIEN

### QUALITÉ

- lame en acier inoxydable type 420
- lame trempée dureté 50-55 Hrc
- rivets finition laiton brillant

### ERGONOMIE

- manche ergonomique bimatière
- forme adaptée au travail du câble
- manche de 10 cm



### CARACTÉRISTIQUES

- 3 positions : fermée, ouverte à 180°, mi-ouverte à 90°
- 1 lame droite de 8 cm, avec 2 encoches : 1 encoche en V coupe-fil et 1 encoche en demi-cercle pour dénuder
- 1 lame courbe type serpette de 7 cm spécialement conçue pour travailler les câbles et les gaines



## COUTEAU D'ÉLECTRICIEN 2 LAMES BIMATIÈRE

- Manche bimatière :  
2 lames en acier inoxydable :
- fonction coupe-fil
  - fonction dénudage.



	L mm	Dim. fermée mm	Longueur de lame mm	g	Ref.
2 lames	177	100 x 18	67	100	6218021401

## COUTEAU D'ÉLECTRICIEN 2 LAMES BOIS

- Manche bois de rose.  
2 lames en acier inoxydable :
- fonction coupe-fil
  - fonction dénudage.



	L mm	Dim. fermée mm	Longueur de lame mm	g	Ref.
2 lames	177	100 x 18	67	100	6218020001

## COUTEAU D'ÉLECTRICIEN 1 LAME BOIS

- Manche bois.  
1 lame en acier inoxydable.



	L mm	Dim. fermée mm	Longueur de lame mm	g	Ref.	
1 lame	177	100 x 18	67	67	6218010001	1



## COUTEAU PROBLADE

### QUALITÉ

- lame en acier inoxydable AUS-8 (acier allié de coutellerie de très haute qualité)
- toutes les pièces du corps du couteau sont en acier inoxydable.



### SÉCURITÉ

- cran d'arrêt
- trou d'accroche pour dragonne.

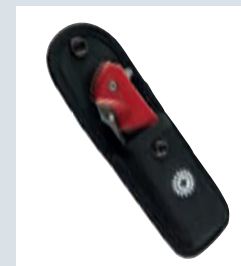
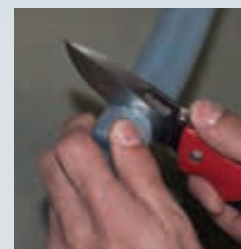

## COUTEAU PROBLADE



L mm	g	Ref.	
205	230	6218010401	1



16



62



96



120



126



156



188



224



248



254



300



316



340



390



462



488



201



# LIMES ET RÂPES



## LIMES ET RÂPES

### LA QUALITÉ DE LA FABRICATION

Le groupe MOB a acquis il y a 30 ans le leader européen des limes et râpes, TALABOT.

- limes : grande longévité de la coupe grâce à l'acier fortement chargé en carbone (1,3 à 1,4 %), allié au chrome pour obtenir un mordant puissant.
- acier des râpes moins chargé en carbone (0,45 %) pour un travail efficace sur les matériaux tendres.
- duretés de  $65 \pm 2$  HRC pour les limes et de 53 HRC pour les râpes.
- conformité à la norme NF E 75 001-75 002.



Fabrication dans nos usines

### DIMENSIONS

Les limes et râpes sont définies par leur longueur (sans la soie) en mm. Pour les limes aiguilles la soie est comprise dans la longueur.

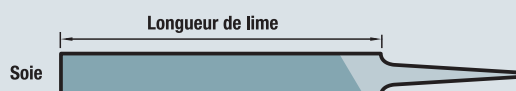

### TAILLE DES LIMES DE MÉCANIQUE

La taille croisée est destinée à la mécanique et à l'ajustage. Elle permet d'augmenter la quantité de matière enlevée.

Ces limes servent à l'ajustage.

Le degré de finesse de la taille se mesure en nombre de dents par cm de longueur. Ce ratio varie en fonction de la dimension de la lime. La finition est :

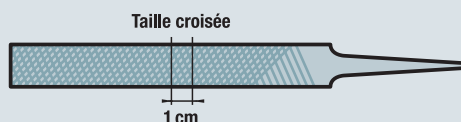

- 1** bâtarde pour le dégrossissage,
- 2** mi-douce pour les travaux courants
- 3** douces pour la finition.



### TAILLE DES LIMES AIGUILLES

Les limes aiguilles, utilisées pour le travail de précision, ont deux types de taille : taille 0 = Mi-douce et taille 2 = Douce.

### TAILLE DES LIMES D'AFFÛTAGE

La simple taille est destinée à l'affûtage des scies, des couteaux, des cisailles ou des chaînes pour tronçonneuse. Elles ont un seul type de taille (2).



### PIQÛRE DES RÂPES

Les piqûres pour les râpes permettent le travail des matériaux tendres : l'aluminium, le plomb, le plastique ou le bois. La finition des râpes se mesure en nombre de piqûres par  $\text{cm}^2$ .

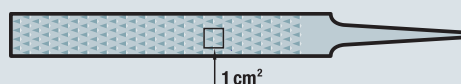

Il y a trois types de piqûre selon le degré de finition que l'on souhaite obtenir :

- 1** grosse piqûre
- 2** moyenne piqûre
- 3** fine piqûre.

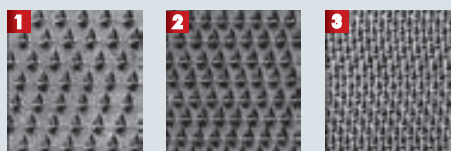



## LES MANCHES DES RÂPES ET LIMES



### MANCHES BOIS

Les manches bois sont tournés en France.  
Les forêts d'origine sont labellisées PEFC.



### MANCHE BIMATIÈRE

Polypropylène : résistance et relief permettant de travailler avec précision.  
Élastomère : souple et confortable.  
Limite la transpiration et l'échauffement de la main.



Code couleur pour distinguer les grandes familles

Travail du bois : orange

Travail du métal : bleu

Affûtage : vert

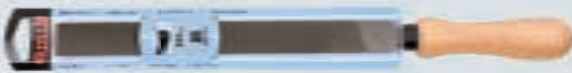

\*Les limes en dimension 100 mm se présentent avec un manche plastique.

#### Emmanchement d'une lime :

- Positionner l'insert sur la lime
- Utiliser un maillet pour enfoncer le manche sur la lime.



16



62



96



120



126



156



188



224



248



254



300



316



340



390



462



488



203



# LIMES DE MÉCANICIEN



## LIMES DE MÉCANIQUE

### LA QUALITÉ DE LA FABRICATION

- Le groupe MOB a acquis il y a 30 ans le leader européen des limes et râpes, TALABOT.
- Les limes se caractérisent par une grande longévité de la coupe grâce à l'acier fortement chargé en carbone (1,3 à 1,4 %). Il est allié au chrome pour obtenir un mordant puissant.
- A chaque coulée, MOB vérifie la composition chimique des aciers.
- La maîtrise parfaite de la trempe, opération capitale pour la qualité de la coupe, permet de garantir des duretés de  $65 \pm 2$  HRC pour les limes et de 53 HRC pour les râpes.
- Les limes et râpes mob sont conformes à la norme NF E 75 001-75 002.

### DIMENSIONS

Les limes et râpes sont définies par leur longueur (sans la soie) en mm.

### TAILLE DES LIMES DE MÉCANIQUE

- Taille croisée
  - Le degré de finesse de la taille se mesure en nombre de dents par cm de longueur.
- Ce ratio varie en fonction de la dimension de la lime.

Les finitions sont :

- bâtardes pour le dégrossissage (1),
- mi-douces (2) pour les travaux courants
- douces (3) pour la finition.

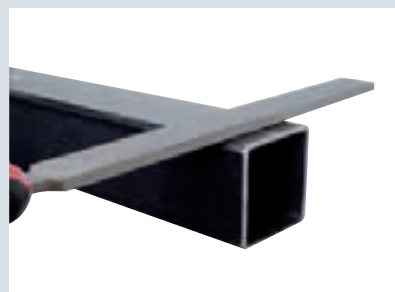
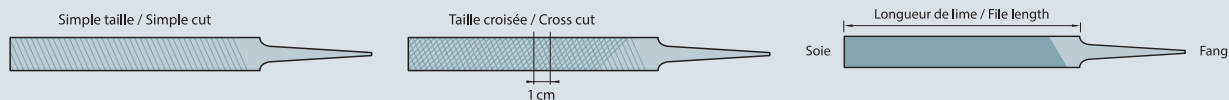



## LIME PLATE À MAIN SANS MANCHE

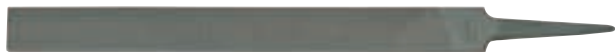

		1		2		3	
L mm		Ref.	☐	Ref.	☐	Ref.	☐
100-4"	12 x 3	0900100101	12	0900100201	12	0900100301	12
125-5"	12 x 3			0900120201	12		
150-6"	15 x 4	0900150101	12	0900150201	12	0900150301	12
200-8"	20 x 5	0900200101	12	0900200201	12	0900200301	12
250-10"	25 x 6	0900250101	12	0900250201	12	0900250301	12
300-12"	30 x 7	0900300101	6	0900300201	6		
350-14"	35 x 8	0900350101	6	0900350201	6		

## LIME PLATE À MAIN MANCHE BOIS



		1		2	
L mm		Ref.	☐	Ref.	☐
200-8"	20 x 5	0900202101	6		
250-10"	25 x 6	0900252101	6	0900252201	6

## LIME PLATE À MAIN MANCHE BOIS SUR CARTE



		1		2	
L mm	Section mm	Ref.	☐	Ref.	☐
100	12 x 3	090010H101	3	090010H201	3
125	12 x 3			090012M201	3
150	15 x 4	090015M101	3	090015M201	3
200-8"	20 x 5	090020M101	3	090020M201	3
250	25 x 6	090025M101	3	090025M201	3

## LIME PLATE À MAIN MANCHE BI-MATIERE



		1		2	
L mm		Ref.	☐	Ref.	☐
150-6"	15 x 4	0900158101	6	0900158201	6
200-8"	20 x 5	0900208101	6	0900208201	6
250-10"	25 x 6	0900258101	6	0900258201	6
300-12"	30 x 7	0900308101	6	0900308201	6

## LIME PLATE À MAIN MANCHE BI-MATIERE SUR CARTE



		1		2	
L mm	Section mm	Ref.	☐	Ref.	☐
150	15 x 4	0900156101	3	0900156201	3
200	20 x 5	0900206101	3	0900206201	3
250	25 x 6	0900256101	3	0900256201	3

## LIME PLATE À MAIN MINCE



		2	
L mm		Ref.	☐
125-5"	14 x 1,75	0902120201	12
150-6"	16 x 2	0902150201	12
200-8"	20 x 2,5	0902200201	12

## LIME PLATE À MAIN MINCE MANCHE BOIS SUR CARTE

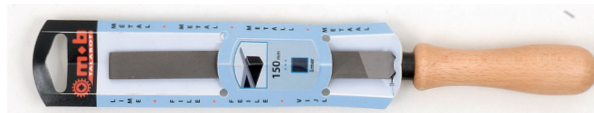

		2	
L mm	Section mm	Ref.	☐
125	14 x 1,75	090212M201	3
150	16 x 2	090215M201	3

## LIME PILIER ÉPAIS SANS MANCHE



		2	
L mm		Ref.	☐
150-6"	11 x 5,5	0903150201	12



16



62



96



120



126



156



188



224



248



254



300



316



340



390



462



488



205



# LIMES DE MÉCANICIEN

## LIME PLATE POUR TOUR SANS MANCHE

1 taille - pour inox.



		2		3	
L mm		Ref.	☐	Ref.	☐
250-10"	25 x 6	0904250201	12		
300-12"	30 x 7	0904300201	6	0904300301	6

## LIME PLATE POINTUE SANS MANCHE

2 bords plats



		1		2		3	
L mm		Ref.	☐	Ref.	☐	Ref.	☐
100-4"	12 x 3			0906100201	12		
150-6"	15 x 4			0906150201	12	0906158201	6
300-12"	30 x 7	0906300101	6				

## LIME PLATE POINTUE MANCHE BOIS SUR CARTE

2 bords plats.

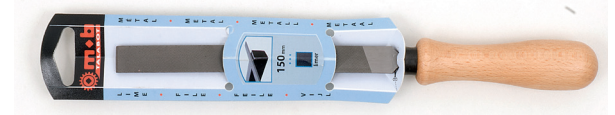

		2	
L mm	Section mm	Ref.	☐
125	12 x 3	090612M201	3
150	15 x 4	090615M201	3
200	20 x 5	090620M201	3

## LIME PLATE POINTUE MINCE



		2	
L mm		Ref.	☐
100-4"	12 x 1,5	0907100201	12
150-6"	16 x 2	0907150201	12
200-8"	20 x 2,5	0907200201	12

## LIME PLATE POINTUE MINCE MANCHE BOIS SUR CARTE

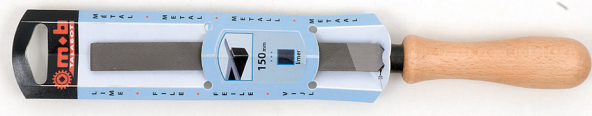

		2	
L mm	Section mm	Ref.	☐
125	14 x 1,75	090712M201	3
150	16 x 2	090715M201	3

## LIME DEMI-RONDE SANS MANCHE



		1		2		3	
L mm		Ref.	☐	Ref.	☐	Ref.	☐
100-4"	11 x 3,5	0910100101	12	0910100201	12		
150-6"	16 x 4,5	0910150101	12	0910150201	12	0910150301	12
200-8"	21 x 6	0910200101	12	0910200201	12	0910200301	12
250-10"	25 x 7	0910250101	12	0910250201	12	0910250301	12
300-12"	30 x 8,5	0910300101	6	0910300201	6		
350-14"	35 x 10	0910350101	6	0910350201	6		

## LIME DEMI-RONDE MANCHE BOIS



		1		2	
L mm	Section mm	Ref.	☐	Ref.	☐
200-8"	21 x 6	0910202101	6		
250-10"	25 x 7	0910252101	6	0910252201	6

## LIME DEMI-RONDE MANCHE BOIS SUR CARTE

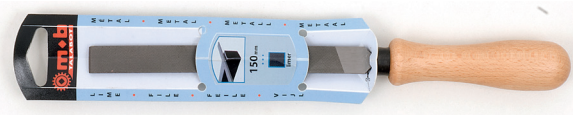

		1		2	
L mm	Section mm	Ref.	☐	Ref.	☐
125	14 x 4			091012M201	3
150	16 x 4,5	091015M101	3	091015M201	3
200	21 x 6	091020M101	3	091020M201	3
250	25 x 7	091025M101	3	091025M201	3





## LIME DEMI-RONDE MANCHE BI-MATIÈRE



		1		2	
L mm		Ref.	☐	Ref.	☐
150-6"	16 x 4,5	0910158101	6	0910158201	6
200-8"	21 x 6	0910208101	6	0910208201	6
250-10"	25 x 7	0910258101	6	0910258201	6
300-12"	30 x 8,5	0910308101	6	0910308201	6

## LIME DEMI-RONDE MANCHE BI-MATIÈRE SUR CARTE

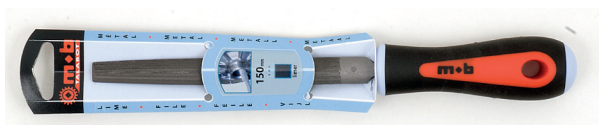

		1		2	
L mm	Section mm	Ref.	☐	Ref.	☐
150	16 x 4,5	0910156101	3	0910156201	3
200	21 x 6	0910206101	3	0910206201	3
250	25 x 7	0910256101	3	0910256201	3

## LIME TRIANGULAIRE SANS MANCHE



		1		2		3	
L mm	Δ mm	Ref.	☐	Ref.	☐	Ref.	☐
100-4"	8			0912100201	12	0912100301	12
150-6"	11	0912150101	12	0912150201	12	0912150301	12
200-8"	15	0912200101	12	0912200201	12	0912200301	12
250-10"	19	0912250101	12	0912250201	12	0912250301	12
300-12"	21	0912300101	6	0912300201	6		

## LIME TRIANGULAIRE MANCHE BOIS SUR CARTE

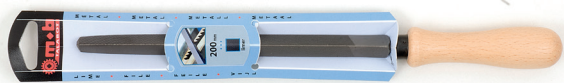

		1		2	
L mm	Δ mm	Ref.	☐	Ref.	☐
150-6"	11			091215M201	3
200-8"	15	091220M101	3	091220M201	3
250-10"	19	091225M101	3		

## LIME TRIANGULAIRE MANCHE BI-MATIÈRE



		1		2	
L mm	Δ mm	Ref.	☐	Ref.	☐
150-6"	11	0912158101	6	0912158201	6
200-8"	15	0912208101	6	0912208201	6
250-10"	19	0912258101	6	0912258201	6

## LIME TRIANGULAIRE MANCHE BI-MATIÈRE SUR CARTE



		1		2	
L mm	A mm	Ref.	☐	Ref.	☐
150	11	0912156101	3	0912156201	3
200	15	0912206101	3	0912206201	3

## LIME CARRÉE SANS MANCHE



		1		2	
L mm		Ref.	☐	Ref.	☐
100-4"	5	0913100101	12	0913100201	12
125-5"	5			0913120201	12
150-6"	6	0913150101	12	0913150201	12
200-8"	8	0913200101	12	0913200201	12
250-10"	10	0913250101	12	0913250201	12
300-12"	12	0913300101	6	0913300201	6

## LIME CARRÉE MANCHE BOIS SUR CARTE



		2	
L mm		Ref.	☐
150-6"	6	091315M201	3
200-8"	8	091320M201	3

## LIME CARRÉE MANCHE BI-MATIÈRE



		1		2	
L mm		Ref.	☐	Ref.	☐
150-6"	6			0913158201	6
200-8"	8	0913208101	6	0913208201	6
250-10"	10			0913258201	6
300-12"	12				



16



62



96



120



126



156



188



224



248



254



300



316



340



390



462



488



207



# LIMES DE MÉCANICIEN

## LIME CARRÉE MANCHE BI-MATIÈRE SUR CARTE

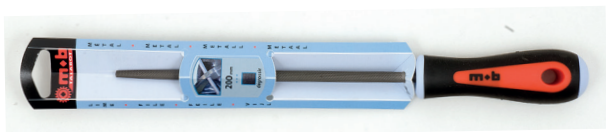

		1		2	
L mm	Section mm	Ref.	∅	Ref.	∅
150	6	0913156101	3	0913156201	3
200	8	0913206101	3	0913206201	3

## LIME RONDE MANCHE BI-MATIÈRE



		1		2	
L mm	∅ mm	Ref.	∅	Ref.	∅
150-6"	6	0914158101	6	0914158201	6
200-8"	8	0914208101	6	0914208201	6
250-10"	10	0914258101	6	0914258201	6

## LIME RONDE SANS MANCHE



		1		2		3	
L mm	∅ mm	Ref.	∅	Ref.	∅	Ref.	∅
100-4"	4	0914100101	12	0914100201	12	0914100301	12
125-5"	5	0914120101	12	0914120201	12		
150-6"	6	0914150101	12	0914150201	12	0914150301	12
200-8"	8	0914200101	12	0914200201	12	0914200301	12
250-10"	10	0914250101	12	0914250201	12	0914250301	12
300-12"	12	0914300101	6	0914300201	6		

## LIME RONDE MANCHE BI-MATIÈRE SUR CARTE

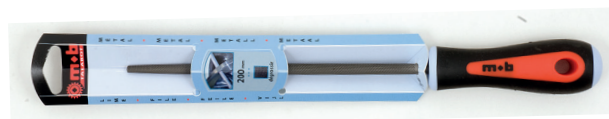

		1		2	
L mm	∅ mm	Ref.	∅	Ref.	∅
150	6	0914156101	3	0914156201	3
200	8	0914206101	3	0914206201	3
250	10	0914256101	3	0914256201	3

## LIME RONDE MANCHE BOIS



		2	
L mm	∅ mm	Ref.	∅
250-10"	10	0914252201	6

## LIME COUTEAU SANS MANCHE



		2	
L mm	Section	Ref.	∅
150-6"	18 x 4	0923150201	12
200-8"	22 x 5	0923200201	12
250-10"	26 x 6	0923250201	12

## LIME RONDE MANCHE BOIS SUR CARTE

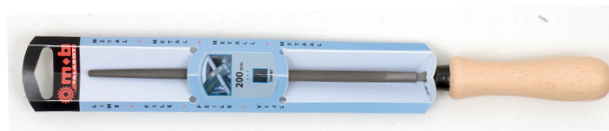

		1		2	
L mm	∅ mm	Ref.	∅	Ref.	∅
100	4			091410H201	3
125	5			091412M201	3
150	6			091415M201	3
200	8	091420M101	3	091420M201	3
250	10	091425M101	3	091425M201	3

## LIME PLATE SPECIALE STRATIFIÉ MANCHE BOIS SUR CARTE



Taille fraisée 5 dents/cm  
- acier au chrome - brise-  
copeau de dégagement.

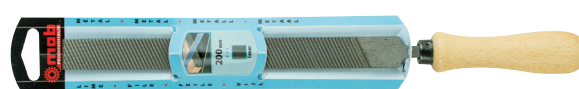

		2	
L mm	Section mm	Ref.	∅
200	20 x 5	092620M501	3



## LIME PLATE SPECIALE STRATIÉ MANCHE BI-MATIÈRE SUR CARTE

Taille fraisée 5 dents/cm - acier au chrome - brise-copeau de dégagement.



L mm	Section mm	Ref.	📦
200	20 x 5	0926206501	3

## LIME DEMI-RONDE POUR MÉTAUX TENDRES SANS MANCHE

Spéciale aluminium.



L mm	Section mm	Ref.	📦
300-12"	30 x 7	0929300401	6

## LIME PLATE POUR MÉTAUX TENDRES SANS MANCHE

Spéciale aluminium



L mm	Section mm	Ref.	📦
300-12"	30 x 7	0925300401	6

## LIME PLATE POUR MÉTAUX TENDRES SUR CARTE

Spéciale aluminium



L mm	Section mm	Ref.	📦
200	20 x 5	092520M201	3

## LIME FRAISEUSE À SOIE OBLIQUE SANS MANCHE

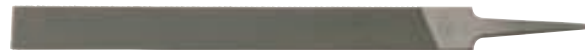

L mm	Ref.	📦	Ref.	📦	Ref.	📦
250-10"					0927250501	6
300-12"	0927300401	6	0927300601	6		

## LIME FRAISEUSE À SOIE CURVILIGNE SANS MANCHE

Sans brise-copeaux.

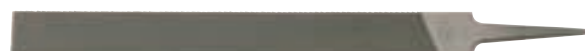

L mm	Ref.	📦	Ref.	📦
300-12"	0928300401	6	0928300601	6

## PLAQUE FRAISEUSE PLATE OBLIQUE

Pour monture à arc

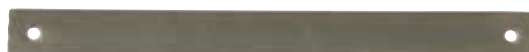

L mm	Ref.	📦	Ref.	📦	Ref.	📦
300-12"	0931300401	6	0931300601	6	0931300501	6
350-14"			0931350601	6		

## PLAQUE FRAISEUSE PLATE CURVILIGNE

Pour monture à arc



L mm	Ref.	📦	Ref.	📦	Ref.	📦
300-12"	0932300401	6			0932300501	6
350-14"	0932350401	6	0932350601	6		

## MONTURE A ARC

Pour plaques fraiseuses 300 et 350 mm.



L mm	g	Ref.	📦
350	420	0933000001	1





# LIME AIGUILLE



## LIME AIGUILLE

### UTILISATION

- Les limes aiguilles se caractérisent par leur petite taille permettant un travail précis.

### CARACTÉRISTIQUES

- Des angles vifs, des extrémités pointues et taillées
- Fabriquées à partir d'acier au chrome, de dureté 66 HRC
- Ebauches d'une grande précision
- Très grande régularité de la taille
- Manche moleté
- Swiss made



### LIME AIGUILLE PILIER



		0		2	
L mm		Ref.	☐	Ref.	☐
140	5,0 x 1,2	0971140001	12	0971140201	12
180	6,4 x 1,5	0971180001	12	0971180201	12
160	5,8 x 1,3	0971160001	12	0971160201	12

### LIME AIGUILLE ENTRÉE



		0	
L mm		Ref.	☐
180	6,0 x 1,2	0972180001	12

### LIME AIGUILLE DEMI-RONDE



		0		2	
L mm		Ref.	☐	Ref.	☐
140	5,2 x 1,6	0973140001	12	0973140201	12
160	5,6 x 1,7	0973160001	12	0973160201	12
180	5,9 x 2,0	0973180001	12	0973180201	12

### LIME AIGUILLE TRIANGULAIRE



		0		2	
L mm	Δ mm	Ref.	☐	Ref.	☐
140	3,5	0974140001	12	0974140201	12
160	3,8	0974160001	12	0974160201	12

### LIME AIGUILLE CARRÉE

Angles vifs, Extrémités pointues et taillées.



		0		2	
L mm		Ref.	☐	Ref.	☐
160	2,4	0975160001	12	0975160201	12
140	2,2	0975140001	12	0975140201	12

### LIME AIGUILLE RONDE



		0		2	
L mm	Ø mm	Ref.	☐	Ref.	☐
140	2,8	0976140001	12	0976140201	12
160	2,9	0976160001	12	0976160201	12

### LIME AIGUILLE COUTEAUX

Angles vifs, extrémités pointues et taillées.



		0	
L mm		Ref.	☐
140	5,0 x 1,4	0978140001	12

### LIME AIGUILLE OVALE



		0	
L mm		Ref.	☐
140	3,5 x 2,4	0979140010	12
160	3,9 x 2,5	0979160010	12
180	4,2 x 2,8	0979180010	12

### LIME AIGUILLE BARRETTE

Angles vifs, Extrémités pointues et taillées.  
Fabriquées à partir d'acier au chrome. Dureté 65 HRC.



		0	
L mm		Ref.	☐
140	5,4 x 2,0	0980180001	12

### LIME AIGUILLE CROCHET

Angles vifs, extrémités pointues et taillées.



		0	
L mm		Ref.	☐
140	4,8 x 1,2	0981140010	12
160	5,4 x 1,3	0981160010	12
180	5,9 x 1,4	0981180010	12

### LIME AIGUILLE PILIER

Bords ronds.



		0	
L mm		Ref.	☐
140	4,8 x 1,2	0982140001	12
160	6,0 x 1,4	0982160001	12



## JEU DE 3 LIMES AIGUILLES

Sous coque.  
Manche rond.  
Plate - mi-ronde - carrée.

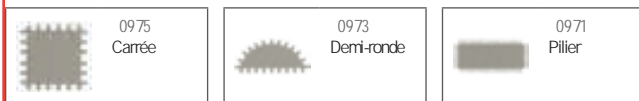

L mm	Ref.	📦
140	098414G201	1

## JEU DE 6 LIMES AIGUILLES

Sous étui.  
Manche rond.  
Pilier - entrée - mi-ronde - carrée - ronde - triangulaire.

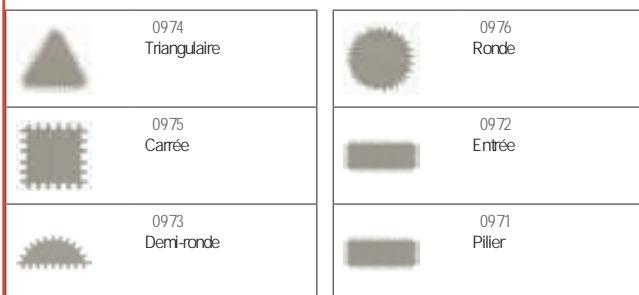

L mm	Ref.	📦
140	0983142001	1
160	0983162001	1
180	0983182001	1

## JEU DE 12 LIMES AIGUILLES

Sous étui.  
Manche rond.  
2 Piliers, Demi-ronde, Feuille de sauge, Couteau, Entrée, Triangulaire, Carrée, Ovale, Ronde, Barrette, Crochet, Pilier bords ronds.

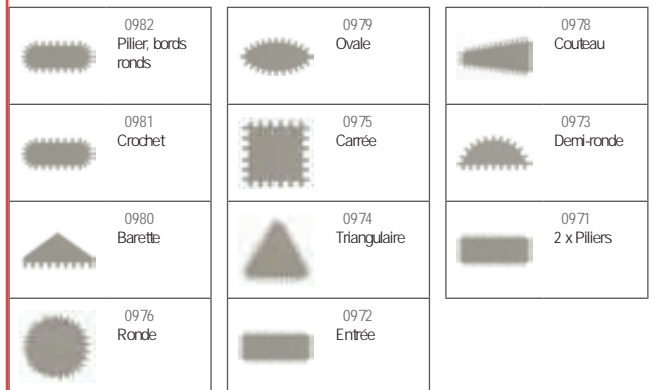

L mm	Ref.	📦
140	0985142001	1
160	0985162001	1

## JEU DE 12 LIMES AIGUILLES

En boîte.  
Manche rond.  
2 Piliers, Demi-ronde, Feuille de sauge, Couteau, Entrée, Triangulaire, Carrée, Ovale, Ronde, Barrette, Crochet, Pilier bords ronds.

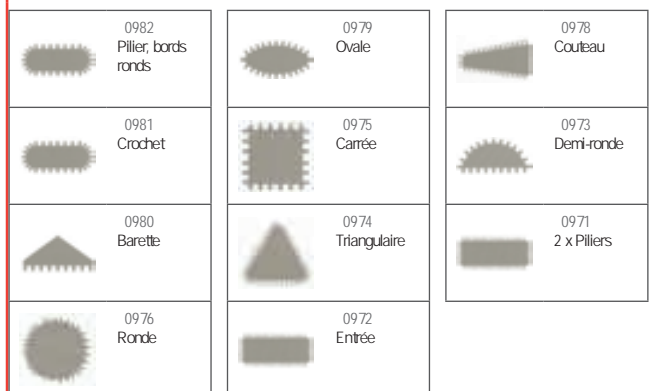

L mm	Ref.	📦
160	0986169001	1





# LIMES D'AFFÛTAGE



## LIMES D'AFFÛTAGE

### UTILISATION

#### Plate « à scie » :

- Forme plate pour l'affûtage des lames de couteaux, de cisailles
- Affûter les lames de tondeuse et outils de jardin (binette, bêche...)
- Affûter les haches et hachettes
- Rectifier les maillons des chaînes de tronçonneuse
- Rajeunir le plat des scies
- Affûter les haches et hachettes

**Tiers-point :** Forme triangulaire pour les dents de scies réaffûtables (tiers point). Plus les dents de scie sont petites, plus la lime doit être effilée en pointe.

#### Lime de tronçonneuse ou « Ronde à chaîne » :

Forme ronde pour affûter les gouges des chaînes de tronçonneuse

### TAILLE

- Taille simple, à la différence des limes de mécanique qui présentent une taille double
- Taille unique mi-douce de type 2.

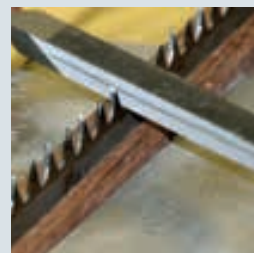

### TIERS POINT - ANGLES VIFS SANS MANCHE



L mm	Δ mm	Ref.	2	3
250-10"	19	0950250201	12	
200-8"	16	0950200201	12	
175-7"	15	0950170201	12	
150-6"	13	0950150201	12	
125-5"	11	0950120201	12	
100-4"	9	0950100201	12	

### TIERS POINT ANGLES VIFS MANCHE BOIS SUR CARTE



L mm	Δ mm	Ref.	2	3
100	9	095010H201	3	
125	11	095012M201	3	
150	13	095015M201	3	
175	15	095017M201	3	
200	16	095020M201	3	

### TIERS POINT ANGLES VIFS MANCHE BI-MATIÈRE



L mm	Δ mm	Ref.	2	3
125-5"	11	0950128201	6	
150-6"	13	0950158201	6	
175-7"	15	0950178201	6	
200-8"	16	0950208201	6	
250-10"	19	0950258201	6	

### TIERS POINT ANGLES VIFS MANCHE BI-MATIÈRE SUR CARTE



L mm	Δ mm	Ref.	2	3
125	11	0950126201	3	
150	13	0950156201	3	
175	15	0950176201	3	
200	16	0950206201	3	

### TIERS POINT ANGLES ROUNDS SANS MANCHE



L mm	Δ mm	Ref.	2	3
150-6"	13	0951150201	12	
175-7"	15	0951170201	12	
200-8"	16	0951200201	12	

### TIERS POINT ANGLES ROUNDS MANCHE BOIS SUR CARTE



L mm	Δ mm	Ref.	2	3
150	13	095115M201	3	
175	15	095117M201	3	
200	16	095120M201	3	



## TIERS POINT EFFILÉ SANS MANCHE



L mm	Δ mm	Ref.	3
100-4"	6	0952100201	12
125-5"	8	0952120201	12
150-6"	9	0952150201	12
200-8"	13	0952200201	12

## TIERS POINT EFFILÉ MANCHE BOIS SUR CARTE



L mm	Δ mm	Ref.	3
100	6	095210H201	3
125	8	095212M201	3
150	9	095215M201	3
175	11	095217M201	3

## TIERS POINT EFFILÉ MANCHE BI-MATIÈRE



L mm	Δ mm	Ref.	3
100-4"	6	0952108201	6
125-5"	8	0952128201	6
150-6"	9	0952158201	6
200-8"	13	0952208201	6

## TIERS POINT EFFILÉ MANCHE BI-MATIÈRE SUR CARTE



L mm	Δ mm	Ref.	3
100	6	0952106201	3
125	8	0952126201	3
150	9	0952156201	3

## TIERS POINT TRÈS EFFILÉ SANS MANCHE



L mm	Δ mm	Ref.	3
100-4"	5	0953100201	12
125-5"	6	0953120201	12
150-6"	8	0953150201	12
175-7"	9	0953170201	12

## TIERS POINT TRÈS EFFILÉ MANCHE BOIS SUR CARTE



L mm	Δ mm	Ref.	3
100	5	095310H201	3
125	6	095312M201	3
150	8	095315M201	3

## TIERS POINT TRÈS EFFILÉ MANCHE BI-MATIÈRE



L mm	Δ mm	Ref.	3
125-5"	6	0953128201	6

## TIERS POINT MACHETTE



Cylindrique pour affûtage des machettes.



L mm	Δ mm	Ref.	3
200-8"	16	0954200201	12

## LIME PLATE À SCIES



Simple taille - 2 bords ronds.



L mm	Ref.	3	
200-8"	21 x 4	0965200201	12
250-10"	25 x 5	0965250201	12

## LIME PLATE À SCIES SANS MANCHE



Simple taille - 1 bord rond - 1 bord plat.



L mm	Ref.	3	
200-8"	21 x 4	0966200201	12
250-10"	25 x 5	0966250201	12

## LIME PLATE À SCIES MANCHE BOIS SUR CARTE



Simple taille - 1 bord rond - 1 bord plat.



L mm	Section mm	Ref.	3
200	21 x 4	096620M201	3

## LIME PLATE À SCIES MANCHE BI-MATIÈRE



Simple taille - 1 bord rond - 1 bord plat.



L mm	Ref.	3	
200-8"	21 x 4	0966208201	6



16



62



96



120



126



156



188



224



248



254



300



316



340



390



462



488

213



# LIMES D'AFFÛTAGE

## LIME PLATE À SCIÉS MANCHE BI-MATIÈRE SUR CARTE

Simple taille  
- 1 bord rond - 1 bord plat.



		2	
L mm	Section mm	Ref.	📦
200	21 x 4	0966206201	3

## LIME SPÉCIALE TONDEUSE SUR CARTE

1 côté double taille pour  
l'ébarbage - 1 côté simple  
taille pour aiguïser la lame.



		2	
L mm		Ref.	📦
200	20 x 5	095720M201	3

## LIME DE TRONÇONNEUSE SANS MANCHÉ SOUS ETUI

Sous étui.



		2	
L mm	∅ mm	Ref.	📦
200	5,5	0970552201	6
200	3,2	0970322201	6
200	4	0970412201	6
200	4,75	0970482201	6

## LIME RONDE DE TRONÇONNEUSE

Pour chaîne de  
tronçonneuse.



		2		2	
L mm	∅ mm	Ref.	📦	Ref.	📦
200-8"	4	0970410301	12	0970418201	6
200-8"	4,75	0970480301	12	0970488201	6
200-8"	5,5	0970550301	12	0970558201	6
200-8"	3,2	0970320301	12		

Chaîne	Lime si chaîne neuve	Lime si chaîne usée
0,404"	∅ 5,5 mm	∅ 4,75 mm
1/4"	∅ 4 mm	∅ 3,2 mm
0,325"	∅ 4,75 mm	∅ 4 mm
3/8"	∅ 5,5 mm	∅ 4,75 mm

## LIME RONDE DE TRONÇONNEUSE MANCHE BOIS SUR CARTE

Pour chaîne de  
tronçonneuse.



		2	
∅ mm	L mm	Ref.	📦
3,2	200	097032G201	3
4	200	097040G201	3
4,75	200	097048G201	3
5,5	200	097055G201	3

## LIME RONDE DE TRONÇONNEUSE MANCHE BI-MATIÈRE

Pour chaîne de  
tronçonneuse.



		2	
L mm	∅ mm	Ref.	📦
200-8"	5,5	0970558201	6
200-8"	4,75	0970488201	6
200-8"	4	0970418201	6
200-8"	3,2		

## LIME RONDE DE TRONÇONNEUSE MANCHE BI-MATIÈRE SUR CARTE

Pour chaîne de  
tronçonneuse.



		2	
∅ mm	L mm	Ref.	📦
3,2	200	0970326201	3
4	200	0970416201	3
4,75	200	0970486201	3
5,5	200	0970556201	3

## JEU DE 2 LIMES NUES DE TRONÇONNEUSE



		2	
L mm	∅ mm	Ref.	📦
200	5,5	098755G201	1
200	4,75	098748G201	1
200	4	098740G201	1
200	3,2	098732G201	1





## RÂPES

### PIQÛRE DES RÂPES

Les piqûres pour les râpes permettent le travail des matériaux tendres : le bois bien sûr, mais aussi l'aluminium, le plomb, le plastique. La finition des râpes se mesure en nombre de piqûres par cm<sup>2</sup>. Il y a trois types de piqûre selon le degré de finition que l'on souhaite obtenir : grosse piqûre ①, moyenne piqûre ② et fine piqûre ③.

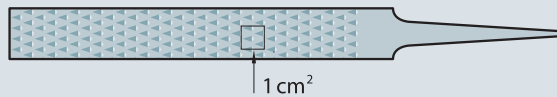
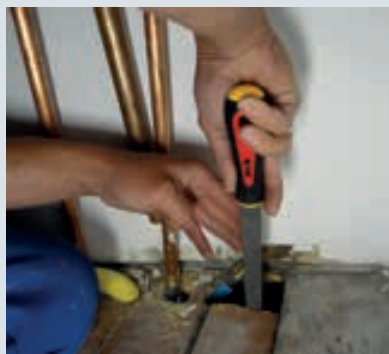
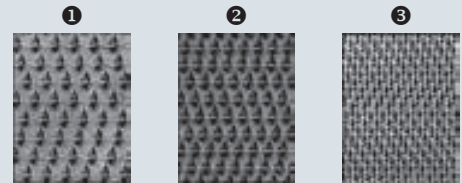

### RÂPE PLATE À MAIN SANS MANCHE



		1		2	
L mm		Ref.	☐	Ref.	☐
150-6"	15 x 4	0940150101	12		
200-8"	20 x 5	0940200101	12	0940200201	12
250-10"	25 x 6	0940250101	12	0940250201	12
300-12"	30 x 7	0940300101	6	0940300201	6

### RÂPE PLATE À MAIN MANCHE BOIS SUR CARTE

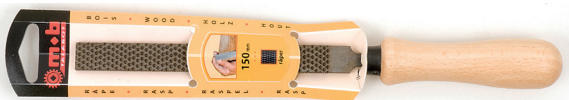

		1		2	
L mm		Ref.	☐	Ref.	☐
150-6"	15 x 4			094015M201	3
200-8"	20 x 5	094020M101	3	094020M201	3
250-10"	25 x 6	094025M101	3	094025M201	3

### RÂPE PLATE À MAIN MANCHE BI-MATIÈRE



		2	
L mm		Ref.	☐
200-8"	20 x 5	0940208201	6
250-10"	25 x 6	0940258201	6

### RÂPE PLATE À MAIN MANCHE BI-MATIÈRE SUR CARTE



		1		2	
L mm	Section mm	Ref.	☐	Ref.	☐
150	15x4			0940156201	3
200	20x5	0940206101	3	0940206201	3
250	25x6			0940256201	3

### RÂPE DEMI-RONDE SANS MANCHE



		1		2		3	
L mm		Ref.	☐	Ref.	☐	Ref.	☐
150-6"	16 x 4,5	0941150101	12	0941150201	12		
200-8"	21 x 6	0941200101	12	0941200201	12	0941200301	12
250-10"	25 x 7	0941250101	12	0941250201	12	0941250301	12
300-12"	30 x 8,5	0941300101	6	0941300201	6		

### RÂPE DEMI-RONDE MANCHE BOIS SUR CARTE

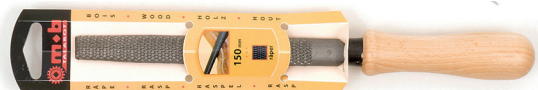

		1		2	
L mm		Ref.	☐	Ref.	☐
150-6"	16 x 4,5			094115M201	3
200-8"	21 x 6	094120M101	3	094120M201	3
250-10"	25 x 7	094125M101	3	094125M201	3



16



62



96



120



126



156



188



224



248



254



300



316



340



390



462



488



215



# RÂPES

## RÂPE DEMI-RONDE MANCHE BI-MATIÈRE



		1		2	
L mm		Ref.	☐	Ref.	☐
150-6"	16 x 4,5			0941158201	6
200-8"	21 x 6	0941208101	6	0941208201	6
250-10"	25 x 7	0941258101	6	0941258201	6

## RÂPE DEMI-RONDE MANCHE BI-MATIÈRE SUR CARTE

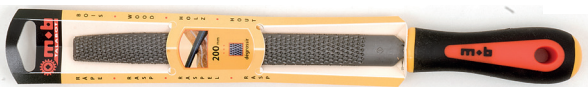

		1		2	
L mm	Section mm	Ref.	☐	Ref.	☐
150	16 x 4,5			0941156201	3
200	21 x 6	0941206101	3	0941206201	3
250	25 x 7	0941256101	3	0941256201	3

## RÂPE RONDE SANS MANCHE



		1		2	
L mm	∅ mm	Ref.	☐	Ref.	☐
150-6"	6	0942150101	12		
200-8"	8	0942200101	12	0942200201	12
250-10"	10	0942250101	12	0942250201	12

## RÂPE RONDE MANCHE BOIS SUR CARTE



		1		2	
L mm	∅	Ref.	☐	Ref.	☐
150-6"	6			094215M201	3
200-8"	8	094220M101	3	094220M201	3
250-10"	10	094225M101	3	094225M201	3

## RÂPE RONDE MANCHE BI-MATIÈRE

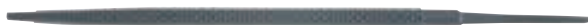

		1		2	
L mm	∅ mm	Ref.	☐	Ref.	☐
150-6"	6			0942158201	6
200-8"	8	0942208101	6	0942208201	6
250-10"	10	0942258101	6	0942258201	6

## RÂPE RONDE MANCHE BI-MATIÈRE SUR CARTE

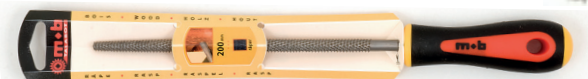

		1		2	
L mm	∅ mm	Ref.	☐	Ref.	☐
150	6			0942156201	3
200	8			0942206201	3
250	10	0942256101	3		

## RÂPE CABINETTE CHAISIÈRE



		2		2	
L mm		Ref.	☐	Ref.	☐
200-8"	23 x 4,5	0943200201	12	094320M201	3
250-10"	28 x 5,5	0943250201	12		

## RÂPE SERRURIÈRE



		2		2	
L mm	∅ mm	Ref.	☐	Ref.	☐
200-8"	8	0944200201	12	094420H201	3
250-10"	10	0944250201	12		

## LIME PLATE SPÉCIALE STRATIFIÉ MANCHE BOIS SUR CARTE



Taille fraisée 5 dents/cm - acier au chrome - brise-copeau de dégagement

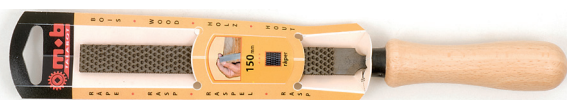

		2		2	
L mm	Section mm	Ref.	☐	Ref.	☐
200	20 x 5	092620M501	3		

## LIME PLATE SPÉCIALE STRATIFIÉ MANCHE BI-MATIÈRE



Taille fraisée 5 dents/cm. Acier au chrome. Brise-copeau de dégagement.



		2		2	
L mm	Section mm	Ref.	☐	Ref.	☐
200	20 x 5	0926206501	3		

## LIME MIXTE MANCHE BOIS SUR CARTE



1 côté lime - 1 côté râpe.



		2		2	
L mm	Section mm	Ref.	☐	Ref.	☐
200	20 x 5	094720M201	3		

## LIME MIXTE MANCHE BI-MATIÈRE SUR CARTE



1 côté lime - 1 côté râpe.



		2		2	
L mm	Section mm	Ref.	☐	Ref.	☐
200	20 x 5	0947206201	3		



## JEU DE 3 RÂPES MANCHE BOIS

- 1 plate
- 1 mi-ronde
- 1 ronde - moyenne piquûre.

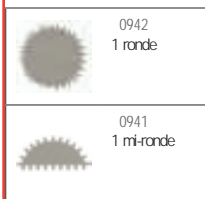

L mm	Ref.	📦
200	0000991801	1

## JEU DE 3 RÂPES MANCHE BI-MATIÈRE

- 1 plate
- 1 mi-ronde
- 1 ronde - moyenne piquûre.

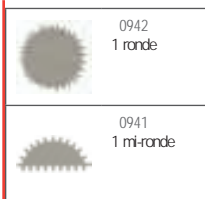

L mm	Ref.	📦
200	0000982801	1

## JEU DE 2 LIMES + 1 RÂPE MANCHE BOIS

- 1 lime plate à main mi-douce
- 1 lime mi-ronde mi-douce
- 1 râpe mi-ronde moyenne piquûre.

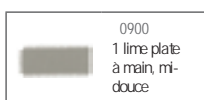
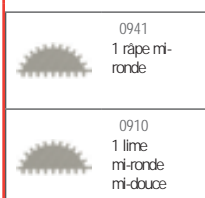

L mm	Ref.	📦
200	0000992301	1

## JEU DE 2 LIMES + 1 RÂPE MANCHE BI-MATIÈRE

- 1 lime plate à main mi-douce
- 1 lime mi-ronde mi-douce
- 1 râpe mi-ronde moyenne piquûre

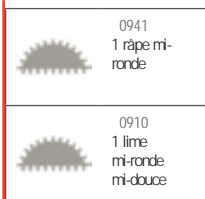

L mm	Ref.	📦
200	0000982701	1

## JEU DE 3 LIMES MANCHE BOIS

- 1 plate à main mi-douce
- 1 mi-ronde mi-douce
- 1 ronde mi-douce.

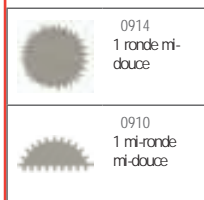

L mm	Ref.	📦
200	0000991901	1

## JEU DE 3 LIMES MANCHE BI-MATIÈRE

- 1 plate à main mi-douce
- 1 mi-ronde mi-douce
- 1 ronde mi-douce.

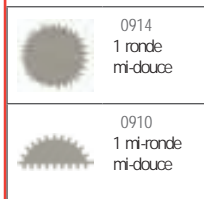

L mm	Ref.	📦
200	0000982601	1

## JEU DE 4 LIMES MANCHE BOIS

- 1 plate à main mi-douce
- 1 plate à main bâtarde
- 1 mi-ronde mi douce
- 1 ronde mi douce.

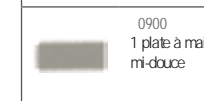
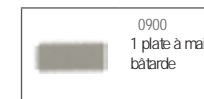

L mm	Ref.	📦
200-8"	0000990E01	1









# TROUSSE DE LIMES

## TROUSSE DE 4 LIMES BIMATIÈRE

- 1 plate à main bâtarde
- 1 plate à main mi-douce
- 1 mi-ronde mi-douce
- 1 ronde mi-douce



 0914 1 ronde mi-douce	 0900 1 plate à main mi-douce
 0910 1 mi-ronde mi-douce	 0900 1 plate à main bâtarde



L mm	Ref.		
200-8"	0935208201		1

## TROUSSE 5 LIMES BIMATIÈRE

- 1 lime plate mi-douce
- 1 demi-ronde mi-douce
- 1 triangulaire mi-douce
- 1 carrée mi-douce
- 1 ronde mi-douce



 0914 1 ronde mi-douce	 0912 1 triangulaire mi-douce	 0900 1 lime plate mi-douce
 0913 1 carrée mi-douce	 0910 1 demi-ronde mi-douce	

L mm	 g	Ref.		
200-8"	1000	0935208501		1
250-10"	1200	0935258501		1

## MODULE DE 5 LIMES

- 200 mm batarde :
- 1 plate à main
- 200 mm mi-doux :
- 1 mi-ronde
  - 1 carrée
  - 1 triangulaire
  - 1 ronde







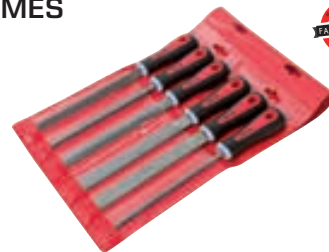

Contenu	 g	Ref.	
Ref.0900+0910+0913+0914+0912	1070	9553005001	1

## TROUSSE 6 LIMES BIMATIÈRE

- 1 plate à main mi-douce
- 1 plate à main bâtarde
- 1 mi-ronde mi-douce
- 1 triangulaire mi-douce
- 1 ronde mi-douce
- 1 carrée mi-douce



 0914 1 ronde mi-douce	 0910 1 mi-ronde mi-douce
 0913 1 carrée mi-douce	 0900 1 plate à main bâtarde
 0912 1 triangulaire mi-douce	 0900 1 plate à main mi-douce



L mm	Ref.		
200-8"	093520S201		1
250-10"	093525S201		1

## LIMES TYPE GENÈVE, JEU DE 3

- Manche bois
- 1 plate à main mi-douce
  - 1 triangulaire mi-douce
  - 1 ronde mi-douce









 0914	 0912	 0900
--	--	--

L mm	Ref.		
100-4"	093510G201		1

## LIMES TYPE GENÈVE, TROUSSE DE 6

- Manche bois - en troussé -
- plate à main
  - plate à main pointue
  - mi-ronde
  - triangulaire
  - carrée
  - ronde



 0914	 0910
 0913	 0906
 0912	 0900

L mm	Ref.		
100-4"	0936103201		1



## MANCHES DE LIMES

### CHOIX DU MANCHE

- bois : un manche bois est léger et confortable
- bi-matière (polypropylène et élastomère) : un manche bi-matière est plus stable et insensible à l'hygrométrie.



### MODE D'EMPLOI

- Positionner l'insert sur la lime
- Utiliser un maillet pour enfoncer le manche sur la lime.



### MANCHE BI-MATIÈRE POUR LIMES SUR CARTE



Inserts	Adapté à	Couleur manche	L mm	Ref.	📦
E04	Lime ronde 150	Bleu	112	0918212001	1
E06	Lime plate et demi-ronde 150, ronde 200, carrée 150 et 200	Bleu	112	0918222001	1
E08	Lime triangulaire 150, demi-ronde 150, ronde et carrée 250	Bleu	112	0918232001	1
E10	Lime triangulaire 200	Bleu	112	0918242001	1
R06 - R08	Lime plate et demi-ronde 200 à 250	Bleu	112	09182A2001	1
R10	Lime plate et demi-ronde 300, triangulaire 250	Bleu	112	0918272001	1

### MANCHE BI-MATIÈRE RÂPES SUR CARTE



Inserts	Adapté à	Couleur manche	L mm	Ref.	📦
E04 - E06 - E08	Râpe 100 à 150	Orange	112	09181B2001	1
E10 - R06 - R08	Râpes 200	Orange	112	09181A2001	1
R08 - R10	Râpes 250 et 300	Orange	112	09181C2001	1

### MANCHE BI-MATIÈRE LIMES AFFUTAGE SUR CARTE



Inserts	Adapté à	Couleur manche	L mm	Ref.	📦
E04	Ronde à chaîne 200, tiers-point 100 à 125	Vert	112	0918312001	1
E06 - E08 - E10 - R10	Tiers-point et plate à scie 150 à 250	Vert	112	09183A2001	1

### MANCHE PLASTIQUE LIME AIGUILLE



L mm	Ref.	📦
82	0918200001	10

### MANCHE BOIS



A mm	B mm	L mm	👤 g	Ref.	📦
10	5	61	5	0915120001	12
10	4	61	5	0915110001	12
10	5	61	5	0915120001	12
12	3	85	20	0915130001	12
12	5/4	85	20	0915140001	12
16	3	109	35	0915150001	12
16	4	109	35	0915160001	12
16	5/3	109	35	0915170001	12
16	6	109	35	0915190001	12
16	7/5	109	35	0915200001	12
16	8,5/6	109	35	0915270001	12
20	5	127	55	0915220001	12
20	7/5	127	55	0915210001	12
20	8,5/5	127	55	0915230001	12
20	9/6	127	55	0915250001	12

### CARDE A LIME

Brosse de nettoyage pour limes et râpes en fil d'acier, ultra fine, manche en bois. Fils en acier trempé.



L mm	Ref.
400	0990040001



16



62



96



120



126



156



188



224



248



254



300



316



340



390



462



488









219



# RÉFÉRENCES DE MANCHES

## Références de manches pour limes et râpes

Type de lime		Longueur de la lime							
		Ref.	100	125	150	175	200	250	300
<b>1 Manche bois</b>									
 Limes de mécanique	Plate à main	0900	0915140001	0915160001	0915190001		0915200001	0915250001	0915250001
	Plate à main mince	0902		0915160001	0915170001				
	Plate pointue	0906		0915160001	0915190001		0915200001	0915230001	
	Plate Pointue mince	0907		0915160001	0915170001				
	Demi-ronde	0910	0915140001	0915170001	0915190001		0915200001	0915220001	0915250001
	Triangulaire	0912		0915170001	0915190001		0915200001	0915210001	
	Carrée	0913			0915160001		0915170001	0915220001	
	Ronde	0914	0915130001	0915150001	0915160001		0915170001		
	Lime plate alu	0925					0915200001		
	Lime plate spécial	0926					0915200001		
	T.P angle vif	0950	0915140001	0915170001	0915170001	0915200001	0915270001	0915250001	
	Tiers point angles ronds	0951		0915170001	0915190001	0915200001	0915270001		
 Limes d'affûtage	T.P effilé	0952	0915130001	0915150001	0915160001	0915170001	0915190001		
	T.P très effilé	0953	0915130001	0915150001	0915150001				
	Plate à scies	0966					0915200001		
	Ronde cylindrique	0970					0915130001		
	Lime spéciale tondeuse	0957					0915200001		
	Râpe plate à main	0940			0915190001		0915270001	0915250001	
 Râpes	Râpe demi-ronde	0941			0915190001		0915200001	0915250001	
	Râpe ronde	0942			0915160001		0915190001	0915210001	
	Râpe cabinette	0943					0915200001		
	Râpe serrurière	0944							
	Lime mixte	0947					0915200001		
<b>2 Manche bi-matière</b>									
 Limes de mécanique	Plate à main	0900			0918222001		09182A2001	09182A2001	09182A2001
	Plate pointue	0906			09182A2001				
	Demi-ronde	0910			0918232001		09182A2001	09182A2001	09182A2001
	Triangulaire	0912			0918232001		0918242001	0918232001	
	Carrée	0913			0918222001		0918222001	0918232001	
	Ronde	0914			0918222001		0918222001	0918232001	
 Limes d'affûtage	T.P angle vif	0950		09183A2001	09183A2001	09183A2001	09183A2001	09183A2001	
	T.P effilé	0952	0918312001	0918312001	09183A2001				
	T.P très effilé	0953		0918312001					
	Plate à scies	0966					09183A2001		
	Ronde cylindrique	0970			-	-	0918312001	-	-
 Râpes	Râpe plate à main	0940		-	09181B2001		09181A2001	09181A2001	-
	Râpe demi-ronde	0941			09181B2001		09181A2001	0918272001	-
	Râpe ronde	0942			09181B2001		09181B2001	09181B2001	-
	Lime mixte	0947					09181A2001		



## CISEAUX MANCHE BOIS

### ERGONOMIE

- Manche étudié pour travailler dans toutes les positions.
- Méplat empêchant l'outil de rouler.
- Essence de bois haute densité : charme (600 kg/m<sup>3</sup>)

### ROBUSTESSE ET MAINTIEN

- Virole de renfort anti-éclatement.
- Précision de frappe grâce à une extrémité plate.
- Virole de renfort pour éviter le champignonage et l'éclatement du bois.

Fabrication forgée



### RÉSISTANCE

- Lame forgée en acier à haute teneur en carbone et en chrome.
- Dureté 59-63HRC.

### FINITION ET MARQUAGE

- Brunissage et vernis de protection
- Marquage précis des dimensions pour une identification facile.

### PRÉCISION

- Usinage de la lame pour un taillant agressif et durable
- Angle à 25°



## CISEAU DE SCULPTEUR



Manche bois.

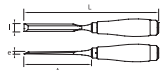

I mm	L mm	A mm	E mm	g	Ref.	☐
4	254	119	3	65	7020040201	5
6	254	119	3	70	7020060201	5
8	264	129	3	75	7020080201	5
10	264	129	3	100	7020100201	5
12	269	134	3,5	110	7020120201	5
14	269	134	3,5	115	7020140201	5
15	269	134	3,5	118	7020150201	5
16	279	144	3,5	135	7020160201	5
18	279	144	3,5	140	7020180201	5
20	284	149	3,5	145	7020200201	5
22	284	149	3,5	155	7020220201	5
25	294	159	4	195	7020250201	5
28	299	164	4	205	7020280201	5
30	299	164	4	215	7020300201	5
35	309	174	4,5	255	7020350201	5
40	309	174	4,5	310	7020400201	5

## CISEAU DE SCULPTEUR SUR CARTE



Manche bois.

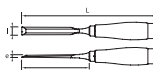

I mm	L mm	A mm	E mm	g	Ref.	☐
4	254	119	3	65	7020041201	3
6	254	119	3	70	7020061201	3
8	264	129	3	75	7020081201	3
10	264	129	3	100	7020101201	3
12	269	134	3,5	110	7020121201	3
14	269	134	3,5	115	7020141201	3
15	269	134	3,5	118	7020151201	3
16	279	144	3,5	135	7020161201	3
18	279	144	3,5	140	7020181201	3
20	284	149	3,5	145	7020201201	3
22	284	149	3,5	155	7020221201	3
25	294	159	4	195	7020251201	3
28	299	164	4	205	7020281201	3
30	299	164	4	215	7020301201	3
35	309	174	4,5	255	7020351201	3
40	309	174	4,5	310	7020401201	3



16



62



96



120



126



156



188



224



248



254



300



316



340



390



462



488



221



# GOUGE DE SCULPTEUR

## GOUGE DE SCULPTEUR



Manche bois.

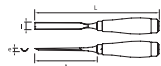

L mm	L mm	A mm	E mm	g	Ref.	☐
8	260	124	4	125	7025080201	1
10	260	124	4	135	7025100201	1
12	260	124	6	145	7025120201	1
14	266	130	7	160	7025140201	1
16	266	130	7	170	7025160201	1
20	266	130	7	180	7025200201	1

## GOUGE DE SCULPTEUR SUR CARTE



Manche bois. Pour creuser le bois, sculpter les parties concaves ou convexes, pour créer des lignes ou des cercles et pour tailler les moulures.

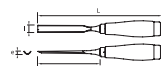

L mm	L mm	A mm	E mm	g	Ref.	☐
8	260	124	4	125	7025081201	1
10	260	124	4	135	7025101201	1
12	260	124	6	145	7025121201	1
14	266	130	7	160	7025141201	1
16	266	130	7	170	7025161201	1
20	266	130	8	190	7025201201	1

## BÉDANE DE MENUISIER



Manche bois.



L mm	L mm	A mm	E mm	g	Ref.	☐
6	285	148	9	170	7010060201	1
8	285	148	9	190	7010080201	1
10	285	148	9	215	7010100201	1

## BÉDANE DE MENUISIER SUR CARTE



Manche bois. Pour creuser et réaliser des mortaises. A utiliser avec un maillet en bois.



L mm	L mm	A mm	E mm	g	Ref.	☐
8	285	148	9	190	7010081201	1
10	285	148	9	215	7010101201	1
14	285	148	9	260	7010141201	1

## JEU DE 3 CISEAUX DE SCULPTEUR BOIS



Contenu	g	Ref.	☐
10 - 15 - 20	580	0000991701	1

## COFFRET 5 CISEAUX DE SCULPTEUR BOIS



Dans coffret en bois.



Contenu	g	Ref.	☐
6 - 10 - 15 - 20 - 25	1545	7000200001	1

## MALLETTE ALU DE 6 CISEAUX BOIS DE SCULPTEUR



Contenu	g	Ref.	☐
6 - 10 - 15 - 20 - 25 - 30	2200	7000300001	1

## JEU DE 6 PETITS OUTILS DE SCULPTEUR

Outils L180mm - contenu :

- 1 fermail droit
- 1 fermail ciseau oblique
- 1 gouge droite
- 1 gouge coupe angulaire
- 1 gouge demi-creuse coudée
- 1 gouge cuillère



g	Ref.	☐
420	7007000201	1

## MANCHE DE RECHANGE CISEAUX A BOIS

Pour réf. 7010 à 7025. Sur carte.

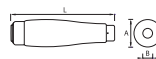

L mm	B mm	A mm	g	Ref.	☐
135	8	25	70	7353001001	1

## PIERRE À AFFÛTER

Rectangulaire - 2 grains : gros = 80 / moyen = 150.



L mm	l mm	H mm	g	Ref.	☐
150	50	25	415	7337000010	1



# CISEAUX MANCHE TRIMATIÈRE



## CISEAUX MANCHE TRI-MATIÈRE

### ERGONOMIE

- Manche ergonomique.
- Zone de frappe en métal : ne champignonne pas, ne se déforme pas.
- Elastomère confortable - Corps en polypropylène.
- Posé, il ne roule pas
- La soie ne vrille pas dans le manche grâce à son assemblage à section angulaire.

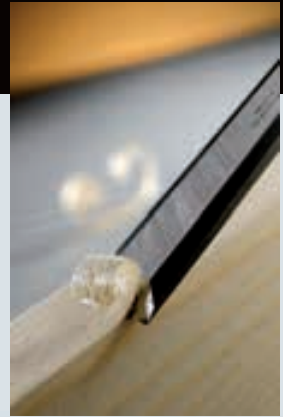

### RÉSISTANCE

- Lame forgée en acier à haute teneur en carbone et en chrome. Dureté 59-63HRC.



### FINITION ET MARQUAGE

- Brunissage et vernis de protection.
- Marquage précis des dimensions pour une identification facile.

### PRÉCISION

- Usinage fin "des faces" pour un taillant de grand de rectitude agressive et durable.
- Angle à 25°.

### SÉCURITÉ

- Embout de protection.



### CISEAU DE SCULPTEUR TRI-MATIÈRE SUR CARTE

Manche tri-matière.

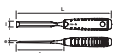

l mm	L mm	A mm	E mm	g	Ref.	
4	254	119	3	85	7020041701	3
6	254	119	3	90	7020061701	3
8	264	129	3	95	7020081701	3
10	264	129	3	120	7020101701	3
12	269	134	3,5	130	7020121701	3
14	269	134	3,5	135	7020141701	3
15	269	134	3,5	138	7020151701	3
18	279	144	3,5	160	7020181701	3
20	284	149	3,5	165	7020201701	3
22	284	149	3,5	175	7020221701	3
25	294	159	4	215	7020251701	3
30	299	164	4	235	7020301701	3
35	309	174	4,5	275	7020351701	3
40	309	174	4,5	330	7020401701	3

### JEU DE 3 CISEAUX DE SCULPTEUR TRI-MATIÈRE

Manche tri-matière.



Contenu	g	Ref.	
15-20-25	580	0000998901	1

### COFFRET 5 CISEAUX DE SCULPTEUR TRI-MATIÈRE

Manche tri-matière.  
Dans coffret en bois



Contenu	g	Ref.	
6-10-15-20-25	1500	7000200701	1

### MALLETTE ALUMINIUM 6 CISEAUX TRI-MATIÈRE

Manche tri-matière.



Contenu	g	Ref.	
6-10-15-20-25-30	2200	7000300701	1



16



62



96



120



126



156



188



224



248



254



300



316



340



390



462



488

223



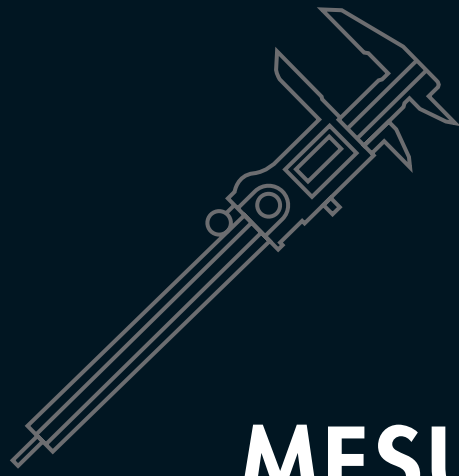

# MÉTROLOGIE, MESURE, TRAÇAGE

**P.226**

PIEDS À COULISSE ET  
JAUGES DE PROFONDEUR



**P.231**

JAUGES, CALIBRE  
ET CHIFFRES À FRAPPER

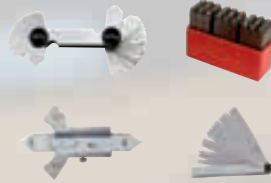

**P.237**

MESURES LONGUES,  
ODOMÈTRE



**P.227**

MICROMÈTRES,  
COMPARATEURS



**P.232**

ÉQUERRES ET  
RAPPORTEURS D'ANGLE



**P.239**

NIVEAUX ET  
RÈGLES BÂTIMENT



**P.229**

RÉGLETS, VES,  
COMPAS  
ET TRAÇAGE



**P.234**

MESURES COURTES



**P.242**

ÉQUERRES BÂTIMENT



**P.243**

TRACAGE, PLOMB  
ET MARQUAGE





# PIEDS À COULISSE



## PIED À COULISSE DIGITAL IP67

### DIGITAL

- L'affichage digital par écran LCD permet de faciliter la lecture
- Lecture de 1/100<sup>ème</sup> de mm.

### ÉTANCHE

- Étanche eau (immersion) et poussière (totale) : indice de protection IP67

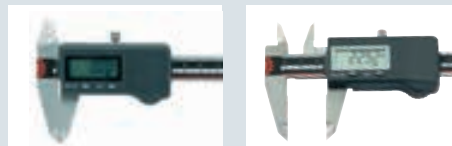

### CARACTÉRISTIQUES TECHNIQUES

- Vitesse de mesure :  $\leq 1.5m/s$
- Température de fonctionnement : 0° à +40° C
- Température de stockage : -10° à +60° C

### ALIMENTATION

- Pile Lithium fournie 3V (CR1632)
- Mise en veille automatique

### MESURES

- Mesure mm/pouces
- Mesure absolue et relative
- Mesure intérieure - extérieure - profondeur

Mesure intérieure



Mesure extérieure



Mesure de profondeur



Mesure décrochement



Mesure extérieure



### PIED À COULISSE DIGITAL IP67



IP67 - Lecture : 1/100<sup>ème</sup> de mm - Mesure mm/pouces - Mesure intérieure-externe-profondeur - Mesure absolue et relative - Arrêt automatique - Acier inoxydable - Vis de blocage - Alimentation par pile bouton CR1632 fournie - Livré en coffret plastique avec notice et certificat de conformité - DIN 862



Capacité	L mm	H mm	E mm	P mm	g	Ref.	
150 mm	236	77	15	16	170	5201150001	1

### PIED À COULISSE DIGITAL

Lecture : 1/100<sup>ème</sup> de mm - Mesure mm/pouces - Mesure intérieure-externe-profondeur - Mesure absolue et relative - Mise en veille automatique - Acier inoxydable - Vis de blocage - Alimentation par pile bouton CR2032 fournie - Livré en coffret plastique avec notice et certificat de conformité - DIN 862

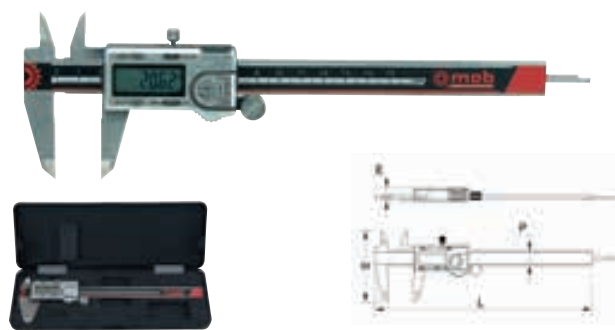

Capacité	L mm	H mm	E mm	P mm	g	Ref.	
150 mm	236	77	14	16	155	5200150001	1



## PIED À COULISSE VERNIER MONOBLOC

Lecture : 1/50 ème - Mesure intérieure-extérieure-profondeur - Acier inoxydable finition mate - Vis de blocage des verniers - Livré en coffret plastique avec certificat de conformité



Capacité	L mm	H mm	E mm	P mm	g	Ref.	☐
150 mm	228	76	7	16	140	5200150101	1
200 mm	290	90	7	17	180	5200200101	1

## PIED À COULISSE VERNIER BECS DROITS

Lecture : 1/50 ème - Mesure intérieure-extérieure - Acier inoxydable finition mate - Vis de blocage des verniers - Livré en coffret plastique avec certificat de conformité

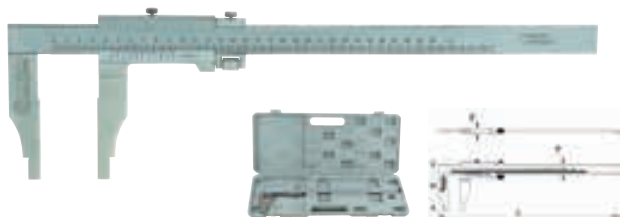

Capacité	L mm	H mm	E mm	P mm	g	Ref.	☐
300 mm	470	137	11	24	820	5202300101	1

## JAUGE DE PROFONDEUR DIGITALE

Lecture : 1/100ème - Mesure mm/pouces - Embase 100mm - Alimentation par pile bouton SR44 fournie - Acier inoxydable - Vis de blocage - Livrée en coffret plastique avec notice et certificat de conformité



Capacité	L mm	H mm	E mm	P mm	g	Ref.	☐
300 mm	380	100	15,5	14	240	5205300001	1

## JAUGE DE PROFONDEUR VERNIER

Lecture : 1/50ème de mm - Vernier monobloc - Avec guide et blocage par vis pour une bonne fiabilité de la mesure - Acier inoxydable chromé mat - Livrée en coffret bois avec certificat de conformité



Capacité	L mm	H mm	E mm	P mm	g	Ref.	☐
200 mm	300	100	10	10	235	5205200101	1



## MICROMÈTRE DIGITAL IP65

### QUALITÉ

- Micromètre de haute précision, pour une utilisation dans les ateliers et dans les industries métallurgiques
- Afficheur LCD pour une bonne lecture
- Lecture 0,001 mm
- Touche carbure Ø6.5 mm



### CARACTÉRISTIQUES TECHNIQUES

- Indice de protection étanchéité eau (protection contre les jets de liquide) et poussière (protection totale) : IP65
- Force de mesure: 5 - 10N
- Environnement de travail : 0° à 40°C
- Température de stockage : -20° à 60°C
- Conforme à la norme DIN 863

### MESURE

- Mesure mm/pouces
- Mesure absolue et relative



Livré en coffret plastique avec certificat de conformité

## MICROMÈTRE DIGITAL IP65

IP65 - Lecture : 0,001 mm - Mesure mm/pouces - Force de mesure : 5 à 10N - Mesure absolue et relative - Alimentation par 1 pile bouton SR44 fournie - Livré en coffret plastique avec notice et certificat de conformité. DIN 863



Capacité	Longueur mm	H mm	Epaisseur mm	g	Ref.	☐
0-25 mm	160	60	27,5	270	5210002501	1





## MICROMÈTRES MÉCANIQUES

### PRÉCISION ET LONGUE DURÉE

Lecture 1/100ème  
 Micromètres de haute précision, qui assurent une très bonne lecture.  
 Sécurité de mesure garantie.  
 Pour une utilisation dans les ateliers et dans les industries métallurgiques.



### QUALITÉ

- Touche carbure Ø6,5mm
- Pour une bonne lecture anti-reflets, les pièces de lecture sont chromées mat. Les traits de graduation sont noirs, non effaçables et bien visibles

Levier de blocage  
 Livré en coffret plastique avec étalon de réglage (à partir de 25-50mm)  
 Conforme à la norme DIN 863



Tableau de marge de déviation autorisée

Capacité en mm	Déviati on maxi de l'affichage	Tolérance de parallé lité des surfaces de mesure par pression de 10N	Flexion autorisée de l'étrier par pression de 10N
0-25	4	2	2
25-50	4	2	2
50-75	5	3	3
75-100	5	3	3

## MICROMÈTRES MÉCANIQUES

Lecture 1/100ème - Touche carbure - Pièces de lecture en chromé mat avec marquage noir pour une bonne lecture - Levier de blocage - Livré en coffret plastique avec étalon de réglage (à partir de 25-50mm)



Capacité	L mm	H mm	E mm	Ø C	g	Ref.	☐
0-25 mm	133	54	21	6,5	170	5211002501	1
25-50 mm	163	72	21	6,5	220	5211255001	1
50-75 mm	182	90	21	6,5	260	5211507501	1
75-100 mm	220	112	21	6,5	330	5211751001	1



## COMPARATEURS

### UTILISATION

- Un comparateur est un instrument de mesure à affichage mécanique. Le déplacement de la tige de mesure est transmis à une aiguille par un système mécanique à crémaillère. L'aiguille se déplace sur 360° sur un cadran rond gradué.
- Cette mécanique de précision permet d'obtenir une pression de mesure constante sur toute la course.

- Précision au 1/100ème de mm
- Cadran tournant
- Livré en coffret plastique 135x85x35 mm
- Conforme à la norme DIN 878



## COMPARATEUR MÉCANIQUE

Lecture 1/100ème de mm  
 Anti-choc avec pattes  
 Cadran tournant Ø58mm  
 Course 10 mm - Corps métallique chromé mat - Tiges en acier trempé inoxydable - Livré en coffret plastique 135x85x35mm



Capacité	Ø mm	g	Ref.	☐
0-10mm	58	185	5215000001	1

## SUPPORT AIMANTÉ POUR COMPARATEUR

Force d'attraction 80 kgs.  
 Socle 50x65x55 mm  
 Support à serrage central.  
 Blocage et désarticulation par came



Dim mm	g	Ref.	☐
50x65x55	1255	5291000001	1

## COMPARATEUR À LEVIER

Lecture au 1/100ème de mm - Capacité 0,40mm  
 - Cadran tournant Ø28mm - Course 0,8 mm - Corps métallique chromé mat - Tiges à bille en carbure Ø2,5 mm - Livré en coffret plastique 98x58x35 mm. DIN 2270.



Capacité	Ø mm	g	Ref.	☐
0-40mm	28	50	5219000001	1



## RÉGLETS

### UTILISATION

- Le réglelet sert à mesurer et reporter des cotes sur les pièces à tracer.
- Un réglelet flexible de 50 cm permet le traçage des parties courbes lorsqu'il est utilisé sur son chant.
- Il sert de jauge de profondeur car l'origine de sa graduation est située à une extrémité.
- Il est gradué en millimètres et demi-millimètres, ce qui lui donne une précision de 0.5 mm.



### QUALITÉ

- Le réglelet flexible est gradué 2 faces
- Gravage chimique profonde indélébile
- Graduation nette
- En acier inoxydable
- Surface satinée mate, anti-reflet, pour une bonne lisibilité
- Avec trou de suspension
- Classe II. Règlementation européenne 2004/22/CE
- Fabriqué en France.

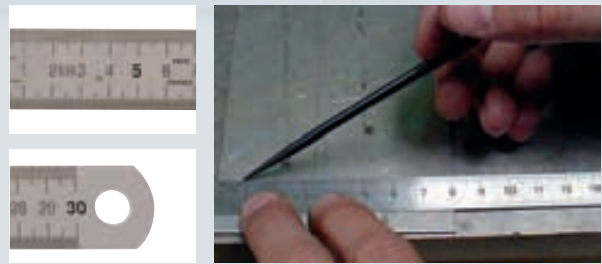

### RÉGLETS INOX FLEXIBLES

Gradué 2 faces. Gravage indélébile. En acier inoxydable. Flexible. Surface satinée mate, anti reflet. Avec trou de suspension. Classe II.



L cm	E mm	g	Ref.	📦
15	0,5	7	6285150001	5
20	0,5	8	6285200001	5
30	0,5	15	6285300001	5
50	0,5	20	6285500001	5

### RÉGLET INOX SEMI-RIGIDE

Haute qualité - 300 mm - 2 faces - Gradué en millimètres et demi-millimètres - En acier inoxydable. Chromé mat. Avec trou de suspension. Classe II.



L cm	g	Ref.	📦
30	15	6283300001	1

### RÈGLE NON GRADUÉE

500 mm - 40x8 - Classe I - NF E-11 / DIN 874. Non graduée, en inox. Livrée en coffret bois avec certificat de conformité.



L mm	E mm	P mm	g	Ref.	📦
500	8	40	1200	5250500001	1

### RÈGLES À FILAMENT

Pour contrôler la planéité.  
NF E-11 / DIN 874.  
En acier inoxydable avec poignée.  
Livrée en étui.



L mm	H mm	E mm	P mm	g	Ref.	📦
75	28	5	11,3	46	5251070001	1
100	23,5	5	11,3	70	5251100001	1
150	28,5	6	12,5	150	5251150001	1
200	29,5	6	12,5	230	5251200001	1

### PAIRE DE VÉS

Précision : 50 microns - Rectifié, haute précision.



Dim. mm	Entailles	g	Ref.	📦
95x70x35	20x30x40x50 mm	2500	5290000001	1

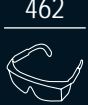



# COMPAS ET TRAÇAGE

## COMPAS

### UTILISATION

- Pour le traçage de cercles, courbes sur surface plane

### CARACTÉRISTIQUES

- En acier poli
- Pointes sèches trempées et rectifiées
- Réglage rapide par bouton moleté
- Charnière à rivet



### COMPAS PORTE-CRAYONS

Pointe trempée et rectifiée. Charnière à rivet. Livré en étui.



L mm	E mm	P mm	ØX maxi	S max mm	g	Ref.	📦
250	25	63	7,5	152,5	330	5240250001	1

### COMPAS À POINTE

En acier poli - Pointes sèches trempées - Branches plates - Réglage rapide par bouton moleté - Livré en étui.



	L mm	E mm	P mm	S max mm	g	Ref.	📦
150	210	19	75	150	150	5241150001	
200	260	19	85	200	160	5241200001	
250	325	24	100	250	265	5241250001	1

### COMPAS À CHARNIÈRE

Pointe trempée et rectifiée - Charnière à rivet. Livré en étui.



	L mm	E mm	P mm	S max mm	g	Ref.	📦
200	215	20	60	200	225	5242200001	
250	265	20	60	250	300	5242250001	1

### POINTE À TRACER



L mm	g	Ref.	📦
190	16	7255190001	5

### POINTE À TRACER

Manche acétate. Chrome vanadium.



L mm	g	Ref.	📦
210	20	7255000010	5

### POINTE À TRACER

Démontable. Chrome vanadium



L mm	g	Ref.	📦
250	35	7256000010	5

### TRACETTE CARBURE

Avec clip.



L mm	S mm	g	Ref.	📦	Ref.	📦
150	16	25	7257000010	5	7257001001	3

### KIT DE TRAÇAGE

Réglet de 20 cm.  
Tracette carbure.  
Pointeau de 6 mm.



g	Ref.	📦
125	0000970901	1





## JAUGES ÉPAISSEUR MÉTRIQUES

Longueur 100 mm  
Jeu de 20 lames pointues  
de 0,05 à 1 mm.



	L mm	E mm	g	Ref.	☐
20 lames : 0,05 à 1 mm	100	18	317	526020001	1

## JAUGES À RAYON

Lames convexes et concaves.



	L mm	E mm	g	Ref.	☐
34 lames : 1 à 7 mm	70	17	68	5265010701	1
32 lames : 7,5 à 15 mm	87	17	110	5265071401	1
30 lames : 15,5 à 25 mm	88	17	118	5265152501	1

## JAUGES DE FILETAGE



	L mm	E mm	g	Ref.	☐
24 lames ISO : 0,25 à 6 mm	70	13	43	5267020001	1
28 lames Whitworth : 4 à 62	70	13	43	5267030001	1
52 lames : 24 ISO + 28 Whitworth	70	13	77	5267010001	1

## CALIBRE DE SOUDEUR

60°-70°-80°-90° Lecture  
1/10 ème - Calibre pour  
contrôler rapidement les  
outils et filets



L mm	H mm	E mm	P mm	g	Ref.	☐
100	14,5	5,3	60	70	5268000001	1



## CHIFFRES ET LETTRES À FRAPPER

### UTILISATION

Ces marques donnent une empreinte lisible pour le repérage de pièces métalliques (outillages...). Le marquage se réalise à l'aide d'un simple marteau.



### CARACTÉRISTIQUES

Dégagement important des empreintes pour une exécution de marquage de qualité. Calibrage des pièces permettant un positionnement facile. Acier étiré extra-dur à haute teneur en carbone, traité à 58/60 HRC et nickelé pour une grande durée de vie. Présentation en boîte plastique rouge.

## CHIFFRES À FRAPPER

De 0 à 9.



mm	g	Ref.	☐
4	180	7267040001	1
5	280	7267050001	1
6	430	7267060001	1
8	790	7267080001	1
10	800	7267100001	1

## LETTRES À FRAPPER

De A à Z + "&"



mm	g	Ref.	☐
4	500	7268040001	1
5	810	7268050001	1
6	1280	7268060001	1
8	2350	7268080001	1
10	2400	7268100001	1



16



62



96



120



126



156



188



224



248



254



300



316



340



390



462



488



# ÉQUERRES



## ÉQUERRES



### UTILISATION

- Pour le contrôle d'équerrage d'angles

### UNE GAMME COMPLÈTE

- Une gamme d'équerres plus larges avec différents modèles proposés : simples, à talon, à onglet, à 45°...

### 2 CLASSES DE PRÉCISION

- Classe I : pour l'industrie mécanique de précision
- Classe II : pour l'industrie mécanique générale

### QUALITÉ

- En acier fraisé rectifié
- Conforme à la norme DIN 875
- Livrées avec certificat de conformité



DIN 875 - Tableau de tolérance de rectangularité de l'angle

Dim. mm (L)	Classe de précision	
	I	II
75	14	28
100	15	30
150	18	35
200	20	40
250	23	45
300	25	50
500	35	70

DIN 875 - Tableau de tolérance de planéité

Dim. mm (L)	Classe de précision		Dim. mm (L)	Classe de précision	
	I	II		I	II
50	5	10	165	7	15
70	5	11	200	8	16
75	6	11	250	9	18
100	6	12	300	10	20
130	7	13	330	11	28
150	7	14	500	14	28

### ÉQUERRES SIMPLES DE PRÉCISION

Classe I. Précision 1/50ème. Conforme DIN 875.



L x P mm	H mm	E mm	Ref.
150x100	26	5,8	5221150001
200x130	29,5	7,3	5221200001

### ÉQUERRES SIMPLES DE MÉCANICIEN

Classe II. Précision 1/25ème. Conforme DIN 875.



L x P mm	H mm	E mm	Ref.
100x70	20	5,8	5222100001
150x100	26	5,8	5222150001
200x130	29,5	7,3	5222200001
300x180	40	9,2	5222300001

### ÉQUERRES À CHAPEAU DE PRÉCISION

Classe I. Précision 1/50ème. Chapeau rapporté vissé. Conforme DIN 875.



L x P mm	H mm	E mm	Ref.
100x70	20	5,8	5224100001
150x100	26	5,8	5224150001
200x130	29,5	7,3	5224200001
250x165	35	7,3	5224250001
300x180	40	9,2	5224300001

### ÉQUERRES À CHAPEAU DE MÉCANICIEN

Classe II. Précision 1/25ème. Chapeau rapporté vissé. Conforme DIN 875.



L x P mm	H mm	E mm	Ref.
100x70	20	5,8	5225100001
150x100	26	5,8	5225150001
200x130	29,5	7,3	5225200001
250x165	35	7,3	5225250001
300x180	40	9,2	5225300001



## ÉQUERRES DOUBLE ONGLET À CHAPEAU

Classe II. Chapeau vissé.  
Pour le contrôle d'angles multiples.  
Conforme DIN 875 / Classe II.



	L mm	H mm	P mm	E mm	g	Ref.
100	93	89	44	6,5	275	5226100001
150	125	135	70	6,5	550	5226150001
200	180	165	93	6,5	930	5226200001

## ÉQUERRE À 45° À CHAPEAU

Conforme DIN 875 /  
Classe II.



	L mm	H mm	P mm	E mm	g	Ref.
150	110	20	104	4,5	235	5227150001



## ÉQUERRE À CENTRER

### UTILISATION

Permet de déterminer le centre d'une pièce ronde ou d'un arc de cercle : tracer d'abord une droite en plaçant les plots sur le bord du cylindre, puis réaliser un deuxième tracé plus loin. L'intersection est le centre du cercle.

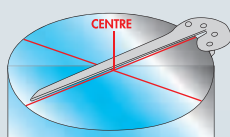

### CARACTÉRISTIQUES

- Équerre en acier
- 4 plots symétriques en acier

## ÉQUERRE À CENTRER



L mm	g	Ref.
170	55	5228170001



## RAPPORTEUR D'ANGLE

### UTILISATION

Pour relever, reporter ou contrôler la valeur d'un angle



### CARACTÉRISTIQUES

- Base du secteur divisée en mm.
- Double division inversée de 0 à 180°.
- Ø du secteur : 90 mm.
- Gravage indélébile. En acier inoxydable.
- Surface satinée. Longueur 240 mm.
- Livré en étui

## RAPPORTEUR D'ANGLE

Double division inversée de 0 à 180°.  
Gravage indélébile. En acier inoxydable.  
Surface satinée.  
Livré en étui.



Ø mm	L mm	H mm	E mm	g	Ref.
90	240	14	14	70	5230150001

## RAPPORTEUR D'ANGLE À SERRAGE CENTRAL

0 à 180°.  
Acier inox chromé mat.  
Livré en étui.



Ø mm	L mm	H mm	E mm	g	Ref.
150	200	16	20	215	5231200001

## RAPPORTEUR D'ANGLE À RÈGLE COULISSANTE

Gradué de 10 à 170° - Règle coulissante avec blocage par vis - Acier inox chromé mat - Livré en étui

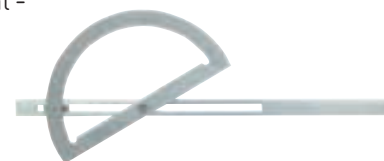

Ø mm	L mm	H mm	E mm	P mm	g	Ref.
200	400	24	20	290	450	5231400001



16



62



96



120



126



156



188



224



248



254



300



316



340



390



462



488



## MESURES ABS

### RÉSISTANCE

- Excellente qualité de ruban nylon.
- Boîtier ABS compact et résistant.

### PRÉCISION

- Précision Classe II : 0,5 mm/m.
- Retour automatique.
- Avec dragonne
- Bouton de blocage rapide et précis de la lame



### MESURE ABS

Précision Classe II : 0,5 mm/m.



L m	l mm	Ref.	
2	16	6270020104	1
3	16	6270030104	1
5	25	6270050104	1
8	25	6270080104	1



## MESURES ROLL'UP MINI

### CARATÉRISTIQUES

- Arrêt du ruban par pression du boîtier.
- Précision Classe II : 0,5 mm/m
- Dos aimanté.



### MESURE MINI ROLL'UP

Précision Classe II : 0,5 mm/m.

**roll up**



L m	l mm	g	Ref.		Ref.	
2	13	80	6270020001	1	6270021001	1



## MESURES ROLL'UP



### CARATÉRISTIQUES

- Boîtier ergonomique bimatière antichoc & anti-dérapant.
- Ruban nylon, résiste à l'humidité et à l'abrasion.
- Clip ceinture résistant.
- Précision Classe II : 0,5 mm/m.
- Crochet multiprise renforcé avec 3 rivets.
- Conforme à la norme européenne MID 2004/22/CE



### MESURE ROLL'UP

Précision Classe II : 0,5 mm/m.



L m	l mm	g	Ref.	☐
3	16	140	6275031401	1
5	19	230	6275051401	1
8	25	415	6275081401	1

### MESURE ROLLUP MAGNET

Boîtier ABS. Avec 2 aimants.  
Crochet 3 rivets.  
Ruban nylon.  
Précision Classe II :  
0,5 mm/m.



L m	l mm	g	Ref.	☐
5	19	230	6275051201	1
8	25	240	6275081201	1



## MESURE BLOCK'UP

### IDÉAL POUR LE TRAVAIL SEUL

- Ruban auto-bloquant pour travailler avec une seule main : le ruban est bloqué automatiquement à sa sortie - le bouton débloque le ruban
- Impression recto-verso bicolore avec une lecture verticale et une horizontale
- Ruban nylon : résiste à l'humidité et à l'abrasion
- Clip ceinture résistant.
- Double crochet renforcé avec 3 rivets
- Précision Class II : 0,5mm/m
- Conforme à la norme européenne MID 2004/22/CE

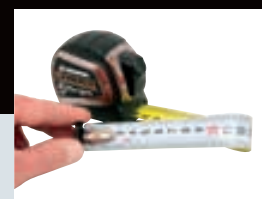

### MESURE BLOCK'UP

Le ruban est bloqué automatiquement à sa sortie.  
Le bouton débloque le ruban - idéal pour le travail seul.



L m	l mm	g	Ref.	☐
5	25	230	6275051101	1





## BOÎTIER G-3LOCK TAJIMA

### UNE MARQUE RÉPUTÉE

La marque Tajima tient son nom de la société japonaise TJM Design Corporation, créée en 1909. Cette société est rapidement devenue leader dans la fabrication du petit outillage professionnel au Japon. L'entreprise au rayonnement international propose aujourd'hui une large gamme de cutters, de mètres-rubans, scies et lames professionnelles.

### BOÎTIER G-3LOCK

- Flèche importante grâce au ruban de 27 mm.
- Boîtier ABS surmoulé en élastomère anti-choc.
- Ruban avec revêtement nylon pour une excellente résistance à la rouille et aux pliures.
- Précision Classe II : 0,5 mm/m
- Agrafe ceinture.
- Triple rivetage du crochet magnétique.
- Amortisseur retour ruban.



Conditionnement en présentoir de 6 pièces pour les réf. 877058, 877158 et 877258.

### BOÎTIER G-3LOCK TAJIMA®

Flèche importante grâce au ruban de 27 mm. Boîtier ABS surmoulé en élastomère anti-choc. Ruban avec revêtement nylon pour une excellente résistance à la rouille et aux pliures. Agrafe ceinture. Triple rivetage du crochet magnétique. Amortisseur retour ruban. Graduation recto-verso. Classe II.



Longueur m	Largeur mm	g	Ref.	📦
5	27	395	877258	6
8	27	390	877288	1

### BOÎTIER W-MAG TAJIMA®

Boîtier de mesure en ABS avec une gaine en élastomère. Boîtier avec socle magnétique. Ruban blanc marqué deux faces. Crochet magnétique.



Longueur m	Largeur mm	g	Ref.	📦
5	25	360	877358	1

### BOÎTIER G LOCK TAJIMA®

Boîtier ABS surmoulé en élastomère anti-choc. Ruban avec revêtement nylon pour une excellente résistance à la rouille et aux pliures. Agrafe ceinture. Triple rivetage du crochet. Amortisseur retour ruban. Classe II.



Longueur m	Largeur mm	g	Ref.	📦
3	16	160	877138	1
5	25	313	877158	6
8	25	490	877188	1
10	25	595	877108	1

### BOÎTIER ABS JAUNE HI LOCK TAJIMA®

Ruban avec revêtement nylon pour une excellente résistance à la rouille, aux pliures... Agrafe ceinture. Amortisseur retour ruban. Classe II.



Longueur m	Largeur mm	g	Ref.	📦
3	16	130	877038	1
5	25	270	877058	6



## MESURES COURTES MONDELIN

### GAMME PRO

Boîtier chromé. Blocage permanent ou temporaire. Ruban protégé par un film nylon anti-abrasion. Agrafe ceinture. Classe II.



Longueur m	Largeur mm	Ref.	Ref.	Ref.	Ref.
5	19	874448	1		
5	25	874458	1		
8	25	874488	1		
10	25	874498	1		

### BOÎTIER BI-MATIÈRE MAGNÉTIQUE

Triple rivetage du crochet magnétique. Blocage permanent. Ruban protégé par un film nylon anti-abrasion. Agrafe ceinture. Classe II.



Longueur m	Largeur mm	Ref.	Ref.	Ref.	Ref.
5	25	875310	1		
8	25	875320	1		

### BOÎTIER BI-MATIÈRE

Triple rivetage du crochet. Blocage permanent. Ruban protégé par un film nylon anti-abrasion. Agrafe ceinture. Classe II.



Longueur m	Largeur mm	Ref.	Ref.	Ref.	Ref.
3	19	873530	1	873538	1
5	25	873550	1	873558	1
8	25	873580	1	873588	1

### BOÎTIER BI-MATIÈRE A RUBAN AUTOBLOQUANT

Triple rivetage du crochet. Agrafe ceinture. Classe II.



Longueur m	Largeur mm	Ref.	Ref.	Ref.	Ref.
5	25	873658	1		
8	25	873688	1		

## MESURES PLIANTES



Longueur m	Matière	Ref.	Ref.	Ref.	Ref.
2	ABS	873120	10	873128	1
2	Bois	873020	10		
2	Aluminium	873220	12	873228	1

## MESURES LONGUES

### BOÎTIER ABS, RUBAN FIBRÉ SYMRON-R TAJIMA®

Impression de la graduation durable et précise. Ruban fibre de verre.



Longueur m	Largeur mm	Ref.	Ref.	Ref.	Ref.
30	13	877308	1		
50	13	877508	1		

### BOÎTIER À POIGNÉE, RUBAN FIBRE DE VÉRRE

Présentation en boîte carton avec trou de suspension.



Longueur m	Largeur mm	Ref.	Ref.	Ref.	Ref.
30	16	876310	1		
50	16	876500	1		

### BOÎTIER À MANCHE RUBAN ACIER AVEC ÉTRIER

Ruban recouvert en polyester anti-abrasion longue durée.



Longueur m	Largeur mm	Ref.	Ref.	Ref.	Ref.
30	13			875230	1
50	13	875250	1		

### BOÎTIER SYNTHÉTIQUE, RUBAN FIBRE DE VÉRRE

Présentation en boîte carton avec trou de suspension.



Longueur m	Largeur mm	Ref.	Ref.	Ref.	Ref.
10	13	876210	1		
20	13	876230	1		



16

62

96

120

126

156

188

224

248

254

300

316

340

390

462

488

237

## Roger MONDELIN ODOMÈTRE

### UTILISATION

- Pour mesurer la longueur d'une piste ou d'une route.

### CARACTÉRISTIQUES

- Utilisation facile : Poignée pistolet avec 2 commandes, 1 pour bloquer la roue et 1 pour réinitialiser le compteur.
- Béquille solide pour tenir l'odomètre debout et rétractable lors de l'utilisation.
- Poignée bimatière pour plus de confort à l'utilisation.
- Mesures précises : système d'affichage mécanique fiable.
- Circonférence de la roue : 1 m.
- Mesure jusqu'à 9999,9 mètres.
- Résolution affichage : 0,1 m.
- Flèche fixée sur l'axe de la roue pour repérer le début et la fin du parcours.
- Conception robuste. Corps en aluminium.
- Conception de transmission par engrenage protégée par brevet.
- Articulation brevetée.
- Diamètre de roue de 320mm.

### TRANSPORT

- Transport facilité : manche pliable.
- Avec sac à dos de rangement.
- Léger : 1.8kg.
- Poignée avec dragonne.

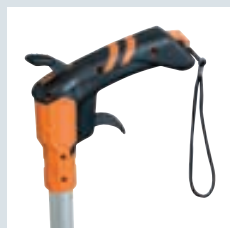
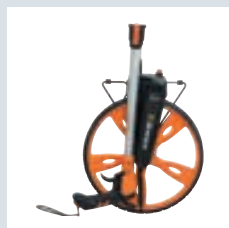
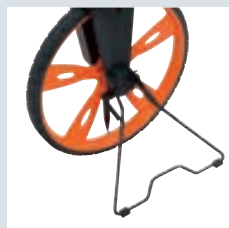

### ODOMÈTRE

Pour mesurer la longueur d'une piste ou d'une route.



 kg	 roue	Ref.	
1,8	320 mm	878000	1



## NIVEAU TRAPÈZE

Corps massif en aluminium moulé.  
Semelle fraisée.  
1 fiole horizontale et 1 fiole verticale.



Longueur cm	Ref.	
40	872400	1
50	872500	1
60	872600	1
80	872800	1
100	872805	1

## NIVEAU TRAPÈZE SEMELLE MAGNÉTIQUE

Corps massif en aluminium moulé.  
Semelle magnétique.  
1 fiole horizontale et 1 fiole verticale.



Longueur cm	Ref.	
40	872100	1
60	872120	1

## NIVEAU PROFIL RECTANGULAIRE

Embouts amortisseurs des chocs.  
Profil aluminium. Peinture époxy orange.  
Poids du profilé : 683 g/m.  
Section du profilé : 50 x 21 mm.  
1 fiole horizontale et 1 fiole verticale.



Longueur cm	Ref.	
40	870400	1
50	870500	1
60	870600	1
80	870800	1
100	871000	1
120	871200	1
150	871500	1
200	872000	1

## NIVEAU PROFIL RECTANGULAIRE MAGNÉTIQUE

Profil aluminium jaune. Semelle magnétique.  
Poids du profilé : 816 g/m. Section du profilé :  
47 x 20 mm. 1 fiole horizontale et 1 fiole verticale.



Longueur cm	Ref.	
60	872160	1

## NIVEAU TRIPLE FIOLE ET DOUBLE POIGNÉE

Embouts amortisseurs de chocs. Double semelle fraisée.  
Profil aluminium. Peinture époxy orange.  
Poids du profilé : 900 g/m.  
Section du profilé : 60 x 24 mm.  
3 fioles : 1 à 180°, 1 à 90° et 1 à 45°.



Longueur cm	Ref.	
60	872170	1
80	872180	1
100	872190	1

## NIVEAU RECTANGLE ALU MOULÉ

Double poignée. 2 fioles.  
Double semelle fraisée.



Longueur cm	Ref.	
40	872040	1
50	872050	1
60	872060	1
80	872080	1
60 magnétique	872140	1

## PAIRE DE NIVEAUX À EAU

2 fioles graduées sur  
10 cm avec bouchon  
d'évacuation d'air.



Ref.	
872850	1

## TUYAU POUR NIVEAU À EAU

Section 10 x 14 mm -  
Cristal. S'adapte sur fioles  
ci-dessus.



Longueur m	Ref.	
50	872900	1
25	872890	1





## NIVEAU COURT NIVOLINER

### COMPACTITÉ

- Longueur 230mm. Corps en aluminium moulé pour une grande résistance aux chocs et à l'abrasion
- Semelle usinée pour une meilleure précision
- Semelle magnétique



### PRÉCISION

- 2 fioles fixes : 1 horizontale et 1 verticale
- Grande fiole centrale pour plus de visibilité
- 1 fiole rotative 180°
- Précision 1mm/m

### NIVEAU COURT MAGNÉTIQUE FIOLE ROTATIVE NIVOLINER

Semelle magnétique avec 2 aimants. Précision : 1mm/m.  
3 fioles. Horizontale, verticale et rotative 180°.



L mm	g	Ref.	📦
230	350	6273001001	1

### NIVEAU RECTANGULAIRE NIVOLINER

- Précision 0.5 mm/m - En aluminium - Deux faces usinées.
- Poignée bimatière :
- 1 poignée sur le 40 cm et 2 poignées sur le 60 cm
- Embouts soft anti-chocs.



L cm	g	Ref.	📦
40	720	6272060001	1
60	930	6272080001	1

### NIVEAU RECTANGULAIRE

Aluminium anodisé.  
2 fioles.  
Embouts plastique.



L cm	g	Ref.	📦
30	170	6251300010	1
40	230	6251400010	1
50	280	6251500010	1
60	330	6251600010	1
80	420	6251800010	1

## **MONDELIN** RÈGLE À NIVEAUX

### LES PLUS

Série PREMIUM

- Excellente prise en main grâce à ses 2 poignées en ABS intégrées parfaitement dans le profil
- Fioles haute qualité pour une règle à niveau très précise
- Supports des fioles en ABS anti-chocs
- Réglage et contrôle des fioles en usine par capteur optique
- Profil aluminium lourd d'excellente qualité section 22 x 100 mm



Fabrication à Ambierle

### RÈGLE À NIVEAUX

Profil alu section. 22 x 100 mm.  
Avec embouts plastiques.  
Deux poignées. Deux fioles.



Longueur m	Ref.	
1,50	351615	1
2	351620	1
2,50	351625	1
3	351630	1

### NIVEAU POUR RÈGLE DE MAÇON

Système clipsable sur le profil alu 100 x 18 mm.



Longueur cm	Ref.	
15	872820	1

## **MONDELIN** RÈGLES ALUMINIUM DE MAÇON

### LES PLUS

- Excellente rigidité
- Très bonne qualité de notre aluminium

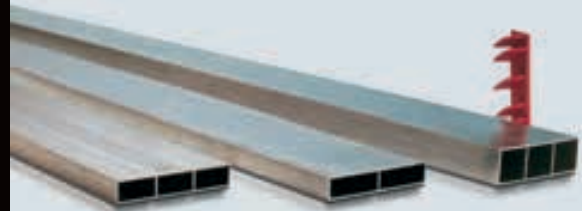

### UTILISATION

- Permet d'enlever le surplus de matière
- Vérifie la planéité

### CHOIX

- Embouts montés sur la règle ou à part
- Embout pour protéger l'extrémité de la règle et éviter que le mortier ne pénètre à l'intérieur de celle-ci.
- Au choix : 1 voile (soit 2 alvéoles) ou pour plus de rigidité 2 voiles (3 alvéoles) ou encore super-rigide : hauteur 100 et 2 voiles (3 alvéoles).



Emballage et protection des règles de maçon



### RÈGLE ALU MAÇON 1 VOILE

100 x 18 mm.  
1 voile (2 alvéoles).



L m	Dimensions mm	Voile	Alvéole	Avec embouts plastique		Sans embout plastique	
				Ref.		Ref.	
2	100 x 18	1	2	351200	5	351020	5
2,5	100 x 18	1	2	351250	5	351025	5
3	100 x 18	1	2	351300	5	351030	5
4	100 x 18	1	2	351400	5	351040	5
5	100 x 18	1	2	351500	5	351050	5
6	100 x 18	1	2	351600	5	351060	5



16



62



96



120



126



156



188



224



248



254



300



316



340



390



462



488



241

# RÈGLES BÂTIMENT

## RÈGLES ALU MAÇON 2 VOILES

100 x 18 mm -  
2 voiles (3 alvéoles).



L m	Dimensions mm	Voiles	Alvéoles	Avec embouts plastique		Sans embout plastique	
				Ref.	📦	Ref.	📦
2	100 x 18	2	3	351720	5	351701	5
2,5	100 x 18	2	3	351725	5	351702	5
3	100 x 18	2	3	351730	5	351703	5
4	100 x 18	2	3	351740	5	351704	5
5	100 x 18	2	3	351750	5	351705	5
6	100 x 18	2	3	351760	5	351706	5

## RÈGLE ALU MAÇON SUPER RIGIDE 2 VOILES

100 x 30 mm super rigide.  
Épaisseur : 1,5 mm.  
2 voiles (3 alvéoles).  
Avec embouts plastique.  
Poids : 1,250 kg/m.



L m	Dimensions mm	Avec embouts plastique	
		Ref.	📦
2	100 x 30	356620	2
2,5	100 x 30	356625	2
3	100 x 30	356630	2
4	100 x 30	356640	2
5	100 x 30	356650	2
6	100 x 30	356660	2

## EMBOUIT PLASTIQUE

Pour règle alu 100 x 18 mm - 1 et 2 voiles. Pour protéger l'extrémité de la règle et éviter que le mortier ne pénètre à l'intérieur de celle-ci.



	Ref.	📦
Carte de 2 embouts	351988	1
Sac de 10 embouts	351995	1
Sac de 100 embouts	351994	1

## RÈGLE ALU PROFIL «I» POUR FAÇADIER

ITE

FAÇADIER



L m	Ref.	📦
1,25	358602	4

Roger MONDELIN

## ÉQUERRE EN ALU

### 2 GAMMES

**RIVETÉE** : assemblage de l'équerre par manchonnage, collage, rivetage qui ne provoque aucune déformation de l'aluminium.

**SODÉE** : assemblage sur station de soudage robotisée. Procédé de soudage innovant sans projection, de type CMT (Cold metal transfer).



## ÉQUERRE EN ALU RIVETÉE AVEC ÉCHARPE

Manchonnée, collée et rivetée.



Hauteur cm	Longueur cm	Ref.	📦
60	80	350010	2
100	60	350040	2
100	150	350020	2
150	200	350030	1



## ÉQUERRE ALUMINIUM SODÉE

Assemblage sur station de soudage robotisée CMT.



Longueur cm	Hauteur cm	Ref.	📦
60	80	350011	2
100	150	350021	2
100	60	350041	2



## ÉQUERRE DE MENUISIER GRADUÉE

Talon aluminium. Lame inox. Gravure laser haute qualité pour un gravage indélébile. Facilité de lecture : très nette.



Longueur cm	Ref.	📦
30	350230	1
40	350240	1



## FAUSSE ÉQUERRE A COULISSE

Lame graduée.  
Talon bois avec 2 garnitures laiton.

Longueur cm	Ref.	📦
25	350270	1
30	350280	1
40	350290	1





## MONDELIN CRAYON DE CHARPENTIER

### UTILISATION

- Crayon pour un marquage propre et précis sur du bois, du béton et autres surfaces.

### QUALITÉ

- Mine tendre facile à affûter
- Forme ovale de 30 cm qui empêche le crayon de rouler et offre une prise en main optimisée
- Vernis rouge protégeant le crayon pour une utilisation en extérieur
- Bois de qualité supérieure pour limiter les risques de casse, même stocké avec des outils lourds
- Livré non taillé

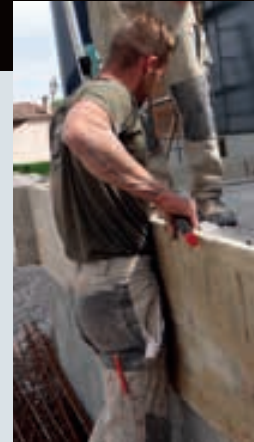

### CRAYON DE CHARPENTIER

Forme ovale.  
Longueur : 30 cm.  
Bois vernis rouge.

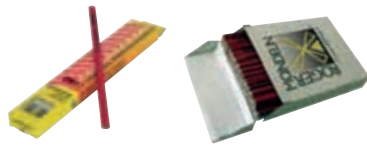

Conditionnement	Ref.	∅
En boîte brochable de 12	811001	12
Carte de 2 pièces	811018	1
Boîte de 72 pièces	811012	1

### CRAYON TAILLEUR DE PIERRE ET MAÇON

Forme ovale.  
Longueur : 30 cm.  
Bois vernis vert.

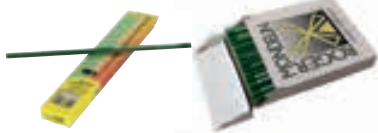

Conditionnement	Ref.	∅
En boîte brochable de 12	811101	12
Carte de 2 pièces	811118	1
Boîte de 72 pièces	811112	1

### TAILLE-CRAYON

Pour les crayons de forme ovale. Corps en ABS, forme ergonomique. Lames en acier. Outil fonctionnel qui permet la coupe des crayons de chantier en deux passages pour obtenir une mine carrée.



Ref.	∅
811150	12

### CRAYON CELLUGRAPH

Crayon universel triangulaire. Pour le marquage sur les surfaces lisses. Mine 4B.



Conditionnement	∅ mm	Ref.	∅
En boîte de 100	4	811160	100
Carte de 2 pièces	4	811168	1

### CRAYON MINE BLANCHE

Pour le marquage sur les carreaux foncés (noirs, gris, taupe...).



Ref.	∅
811120	12
811128	1

### ETUI DE 12 CRAIES INDUSTRIELLES HEXAGONALES



Coloris	Longueur cm	∅ cm	Ref.	∅
Rouge	12	1,2	813150	1
Jaune	12	1,2	813160	1
Bleu	12	1,2	813170	1
Blanc	12	1,2	813180	1

### ETUI DE 12 CRAIES DE BRIANÇON

Destiné au marquage sur les métaux.  
Couleur : blanche.



Coloris	Longueur cm	Ref.	∅
Blanche	10	813190	1

### FEUTRE À ENCRE INDÉLÉBILE ONYX-MARKER

Petit modèle - Corps plastique.  
Pointe biseautée.



Conditionnement	Coloris	Ref.	∅
Boîte de 12 pièces	Rouge	813330	1
Carte de 2 pièces	Rouge	813338	1
Boîte de 12 pièces	Bleu	813360	1
Carte de 2 pièces	Bleu	813368	1
Boîte de 12 pièces	Noir	813390	1
Carte de 2 pièces	Noir	813398	1

### FEUTRE À ENCRE INDÉLÉBILE ONYX-MARKER

Grand modèle - Corps métallique.  
Pointe biseautée.



Conditionnement	Coloris	Ref.	∅
Boîte de 12 pièces	Rouge	813430	1
Boîte de 12 pièces	Bleu	813460	1
Boîte de 12 pièces	Noir	813490	1



16



62



96



120



126



156



188



224



248



254



300



316



340



390



462



488



# TRAÇAGE, PLOMB ET MARQUAGE



## POUDRE À TRACER

### UTILISATION

- Pour tous travaux de traçage en maçonnerie, charpente, couverture.
- Peut s'utiliser sur les chantiers intérieurs et extérieurs
- Compatible avec tous les modèles de cordeaux.
- Excellente tenue sur toutes les surfaces.
- Bonne résistance aux intempéries.



### POUDRE À TRACER 200 G

Biberon de 200 g net.

Coloris	Contenance g net	Ref.	📦
Bleu	200	814180	6
Rouge	200	814190	6



### POUDRE À TRACER 400G

Biberon de 400 g net.

Coloris	Contenance g net	Ref.	📦
Bleu	400	814360	6
Rouge	400	814370	6
Jaune	400	814380	6
Blanc	400	814350	6



### POUDRE À TRACER 1 KG

Biberon de 1 kg net.

Coloris	Contenance kg net	Ref.	📦
Bleu	1	814410	6
Rouge	1	814420	6
Jaune	1	814430	6



### POUDRE À TRACER 3,5 KG

Biberon de 3,5 kg net.



Coloris	Contenance kg net	Ref.	📦
Bleu	3,5	814500	1
Rouge	3,5	814510	1

### POUDRE À TRACER LONGUE DURÉE

Spéciale pour travaux extérieurs. Qualité supérieure.



Coloris	Conditionnement	Contenance kg net	Ref.	📦
Bleu	Biberon	0,200	814200	6
Bleu	Biberon	0,400	814390	6
Bleu	Biberon	1	814440	6
Bleu	Sac	25	814820	1
Rouge	Sac	25	814830	1



## TRAÇEUR DE CHANTIER TRACE

### BOUCHON DE SÉCURITÉ

- Fiabilité : pas de fuites grâce au bouchon de sécurité exclusif
- Bonne utilisation de la peinture : la bombe se vide à 98%

### MARQUAGE TEMPORAIRE

- Température d'utilisation : -15 à +50°C
- Bonne visibilité sur supports béton, bitume, gazon, piquets...
- Inflammable.
- Non irritant (Xi), ni nocif (Xn), ni toxique.

# TRACE

Bouchon exclusif



### TRAÇEUR DE CHANTIER TRACE

Marquage temporaire.



Couleur	Contenance ml	Ref.	📦
Rouge	500	6264500201	12
Jaune	500	6264500301	12
Orange	500	6264500401	12
Vert	500	6264500501	12
Bleu	500	6264500001	12
Blanc	500	6264500101	12



## CORDEAU-TRAÇEUR STOPLINE

### QUALITÉ

- Bonne absorption de la poudre et bonne restitution pour un trait net.

### CARACTÉRISTIQUES

Bouton poussoir à 2 positions : ouverte ou fermée.



## CORDEAU-TRAÇEUR STOPLINE

Boîtier plastique jaune et gris avec poignée en élastomère noire. Polycoton tressé Ø 1,5 mm.



	Longueur m	Ø mm	Ref.	☐
Cordeau seul	30	1,5	815000	6
Cordeau avec 1 biberon de poudre 200g qualité supérieure en coffret	30	1,5	815002	6

## CORDEAU-TRAÇEUR BOÎTIER BLEU/ROUGE

Boîtier plastique. Coton câblé.



Longueur m	Ø mm	Ref.	☐	Blister	
				Ref.	☐
15	1	814910	6	814918	6
20	1	814920	6	814928	6

## CORDEAU-TRAÇEUR BOÎTIER ROND ORANGE

Coton tressé. Boîtier plastique.



Longueur m	Ø mm	Ref.	☐	Blister	
				Ref.	☐
30	1,5	814930	6	814938	1

## CORDEAU-TRAÇEUR BOÎTIER ALU

Retors polyester.



Longueur m	Ø mm	Ref.	☐	Blister	
				Ref.	☐
15	1	814950	6	814958	1
30	1	814960	6	814968	1

## CORDEAU DOUBLE DE CHARPENTIER

Coton tressé.



Longueur m	Ø mm	Ref.	☐	Blister	
				Ref.	☐
30	1,5	814940	1		

## CORDEAU-TRAÇEUR RAPID-LINE

Système de verrouillage/déverrouillage du cordeau. Bobinage rapide. Boîtier plastique jaune/noir. Blocage manivelle. Coton câblé.



Longueur m	Ø mm	Ref.	☐	Blister	
				Ref.	☐
30	1	815030	6	815038	1

## CORDEAU-TRAÇEUR RONDO-LINE

Boîtier plastique jaune. Polycoton tressé Ø 1,6 mm - 30 m.



Longueur m	Ø mm	Ref.	☐	Blister	
				Ref.	☐
30	1,6	815010	6	815018	1

## CORDEAU-TRAÇEUR RONDO-LINE AVEC POUVRE

Boîtier plastique jaune. Polycoton tressé Ø 1,6 mm - 30 m. En coffret avec 1 biberon de 120 g bleue.



Longueur m	Ø mm	Ref.	☐
30	1,6	815017	1

## CORDEAU-TRAÇEUR COSMOS-LINE

Système de bobinage rapide. Boîtier alu. Peinture époxy orange. Blocage manivelle. Polycoton tressé Ø 1 mm - 30 m.



Longueur m	Ø mm	Ref.	☐	Blister	
				Ref.	☐
30	1	814970	6	814978	1



16



62



96



120



126



156



188



224



248



254



300



316



340



390



462



488

# TRAÇAGE, PLOMB ET MARQUAGE

## CORDEAU-TRACEUR GEANT 50 M

Boîtier plastique.  
Manivelle en acier, rabattable.  
Coton câblé Ø 3 mm.  
Capacité : 500 g de poudre.



Longueur m	Ø mm	Ref.	📦
50	3	814990	1

## CORDEAU-TRACEUR MAGNUM 50 M

Bague laiton.  
Poignée élastomère.  
Manivelle en acier, rabattable.  
Cordeau polycoton tressé Ø 2,5 mm.  
Capacité : 500 g de poudre.



Longueur m	Ø mm	Ref.	📦
50	2,5	814997	1

## CORDEAU-TRACEUR MINI-GEANT 30 M

Boîtier plastique.  
Manivelle en acier, rabattable.  
Cordeau polycoton tressé Ø 2,5 mm.



Longueur m	Ø mm	Ref.	📦
50	2,5	814980	1

## CORDEAU-TRACEUR CORDO 30 M

Boîtier plastique.  
Grande capacité.  
Manivelle en acier, rabattable.  
Coton tressé Ø 2 mm.



Longueur m	Ø mm	Ref.	📦
30	2	815020	1

## CORDEAU DE RECHANGE



Conditionnement	Ø mm	Longueur m	Pour ref.	Ref.	📦
Carotte coton câblé	1	15	81491 et 81495	814904	10
Carotte coton câblé	1	20	81492	814905	10
Carotte coton tressé	1,5	30	81493	814902	10
Carotte coton câblé	1	30	81493 et 81500	814906	10
Carotte coton tressé	1,6	30	81501	814907	10
Carotte coton tressé	2	30	814901 et 815020	814901	10
Bobine coton tressé	2,5	30	81498 et 81490	814981	1
Bobine coton câblé	3	50	81499	814991	1

## ROLICORD'

Petit modèle.  
Cordeau câblé en polypro rouge.  
Enrouleur à cordeau avec poignée démontable pour fixer dans un jalon (voir ci-dessous jalon réf. 801620).  
Rembobinage grâce à la poignée et au bouton de manivelle.  
Blocage du cordeau dans 2 positions.



Longueur m	Ø mm	Ref.	📦
60	2	823220	1

## ROLICORD'

Grand modèle.  
Cordeau tressé en polypro jaune.  
Enrouleur à cordeau avec poignée démontable pour fixer dans un jalon (voir ci-dessous jalon réf. 801620).  
Rembobinage grâce à la poignée et au bouton de manivelle.  
Blocage du cordeau dans 2 positions.



Longueur m	Ø mm	Ref.	📦
75	2	823320	1
100	1,5	823310	1

## JALON ROUGE ET BLANC

Tube Ø 22 mm.  
Emboîtable.



Longueur utile m	Ø mm	Ref.	📦
1	22	801620	12

## CORDAMAIN

Enrouleur à cordeau particulièrement ergonomique avec dispositif de blocage du fil.  
Cordeau tressé Ø 1,5 mm, polypropylène jaune 50 m.



Conditionnement	Ø mm	Longueur m	Ref.	📦
Vrac	1,5	50	823250	1





## PLOMB DE MAÇON AVEC ENROULEUR ET CORDEAU



N°	g	Ref.	Cube
45	450	815140	1
60	600	815160	1
85	850	815170	1

## PLOMB DE MAÇON AVEC PLAQUETTE

Peinture époxy.

N°	g	Ref.	Cube
4	400 environ	815040	1
6	600 environ	815060	1
8	800 environ	815080	1
10	1000 environ	815100	1
12	1200 environ	815120	1



## PLOMB TOUPIE

Peinture époxy. Enrouleur statique permet d'utiliser la longueur de cordeau nécessaire.

g	Ref.	Cube
500	815180	1
700	815190	1

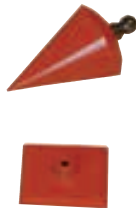

## PLOMBETTE

Pour architectes, carreleurs...



g	Ref.	Cube
100	815208	2

## CORDEAU COTON CÂBLÉ

Longueur m env.	Ø mm	Conditionnement	Ref.	Cube
43	2	En peloton de 100g	822010	10
215	2	En bobine de 500g	822050	6



## CORDEAU COTON TRESSÉ

Longueur m env.	Ø mm	Conditionnement	Ref.	Cube
59	1,5	En peloton de 100g	821510	10
295	1,5	En bobine de 500g	821550	6
24	3	En peloton de 100g	823010	10
120	3	En bobine de 500g	823050	6
20	3	Dévidoir avec trou de suspension	823060	12



## CORDEAU POLYAMIDE CÂBLÉ

Longueur m env.	Ø mm	Conditionnement	Ref.	Cube
200	2	Bobine	821420	1
60	2	Dévidoir avec trou de suspension	821440	12



## TRESSE POLYPROPYLENE BLANCHE



Longueur m env.	Ø mm	Conditionnement	Ref.	Cube
85	1,5	Bobine de 100g	821530	10
200	1,5	Bobine avec flasque	821520	6
45	2,5	Bobine de 100g	822030	10
200	3	Bobine avec flasque	823020	1

## TRESSE POLYPROPYLENE FLUO ROSE

Longueur m env.	Ø mm	Conditionnement	Ref.	Cube
200	1,5	Bobine avec flasque	823110	6
200	2,5	Bobine avec flasque	823120	1



## TIREFIL®

Pour faciliter le passage des fils dans les gaines. Retors polyamide haute résistance. Résistance 100 kg à la rupture pour 1000 m. Blanc/Noir. Qualité supérieure. Présentation sur tube.

Longueur m	Ø mm	Ref.	Cube
1000	2	823400	1



## CHABLOT



Matière	Longueur m	Ø mm	Ref.	Cube
Polypropylène blanc	4	10	824000	10
Chanvre	4	10	824010	10

## CORDE À POULIE POLYPROPYLENE JAUNE ET NOIR

Traité anti-UV - Norme AFNOR. Avec boucle épaissée et crochet de levage avec linguet de sécurité.



Longueur m	Ø mm	Ref.	Cube
20	20	824200	1
30	20	824210	1

## CORDAGE POLYPROPYLENE JAUNE ET NOIR

Traité anti-UV.



Longueur m	Ø mm	Résistance Kg	Ref.	Cube
25	10	1560	824100	1
25	14	3060	824140	1



16



62



96



120



126



156



188



224



248



254



300



316



340



390



462



488



247

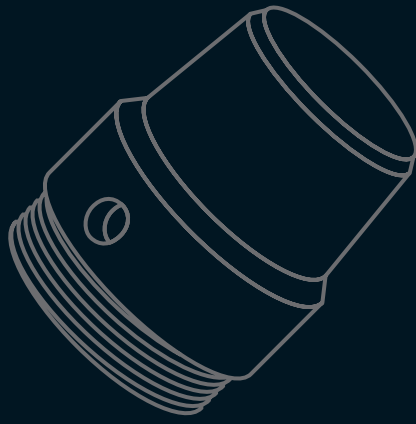

# 009

## DÉCOUPE JOINTS

**P.250**  
| COFFRETS  
DÉCOUPE-JOINTS



**P.251**  
| TUBES LISSES  
ET ACCESSOIRES



**P.253**  
| MACHINE À DÉCOUPER  
LES JOINTS



**P.252**  
| EMPORTE-PIÈCE  
À ARCHE





## EMPORTE-PIÈCES

### UNE OFFRE COMPLÈTE

Gamme industrie complète d'emporte-pièces :

- Des tubes filetés de diamètres 2 à 10 mm
- Des tubes lisses de diamètres 10 à 100 mm
- Une machine à découper de 80 à 1250 mm

La résistance des tubes est comprise entre 162 et 180 kg/mm<sup>2</sup>

Découpe de matériaux tendres (caoutchouc, cuir, feutre, mousse, Téflon,...) ou armés de fibre de verre ou d'acier (jusqu'à 0,3 mm).

Test qualité



Voir la vidéo :

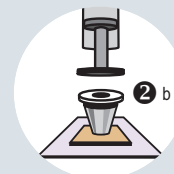

### MODE D'UTILISATION DES EMPORTE-PIÈCES

1 Jusqu'au diamètre 30 mm :

- Monter sur le manche de centrage les tubes pour obtenir les diamètres souhaités.
- Poser le matériau à découper sur une surface plane en bois ou plastique dur.
- Frapper sur le manche de centrage avec un maillet en bois ou caoutchouc.

2 Pour les diamètres supérieurs à 30 mm :

- Monter sur le bloc de centrage les tubes pour obtenir les diamètres souhaités.
- a) Emploi manuel
  - Poser l'emporte-pièce sur un plan de travail avec les tranchants vers le haut.
- b) Poser par dessus le matériau à découper et frapper directement avec un maillet sur le matériau.



16



62



96



120



126



156



188



224



248



254



300



316



340



390



462



488



# COFFRETS DÉCOUPOIRS

## COFFRET DÉCOUPOIRS Ø 3 A 20 MM (PAIR)

- Tubes filetés Ø 3-4-6-8-10 mm.
- Tubes lisses Ø 12-14-16-18-20 mm.
- Manche de centrage réf. 8008010001.



g	Ref.	
700	8004209001	1

## COFFRET DÉCOUPOIRS Ø 2 A 19 MM (IMPAIR)

- Tubes filetés Ø 2-3-5-7-9 mm.
- Tubes lisses Ø 11-13-15-17-19 mm.
- Manche de centrage réf. 8008010001.



g	Ref.	
700	8004219001	1

## COFFRET DÉCOUPOIRS Ø 3 A 30 MM (PAIR)

- Tubes filetés Ø 3-4-6-8-10 mm.
- Tubes lisses Ø 12-14-16-18-20-22-24-26-28-30 mm.
- Manche de centrage réf. 8008020001.



g	Ref.	
1400	8004309001	1

## COFFRET DÉCOUPOIRS Ø 2 A 29 MM (IMPAIR)

- Tubes filetés Ø 2-3-5-7-9 mm.
- Tubes lisses Ø 11-13-15-17-19-21-23-25-27-29 mm.
- Manche de centrage réf. 8008020001.



g	Ref.	
1400	8004319001	1

## COFFRET DÉCOUPOIRS Ø 3 A 40 MM (PAIR)

- Tubes filetés Ø 3-4-6-8-10 mm.
- Tubes lisses Ø 12-14-16-18-20-22-24-26-28-30-32-34-36-38-40 mm.
- Bloc de centrage réf. 8009020001.



g	Ref.	
2000	8004409001	1

## COFFRET DÉCOUPOIRS Ø 3 A 50 MM (PAIR)

- Tubes filetés Ø 3-4-6-8-10 mm.
- Tubes lisses Ø 12-14-16-18-20-22-24-26-28-30-32-34-36-38-40-42-44-46-48-50 mm.
- Bloc de centrage réf. 8009030001.



g	Ref.	
3300	8004509001	1

## COFFRET DÉCOUPOIRS Ø 2 A 49 MM (IMPAIR)

- Tubes filetés Ø 2-3-5-7-9 mm.
- Tubes lisses Ø 11-13-15-17-19-21-23-25-27-29-31-33-35-37-39-41-43-45-47-49 mm.
- Bloc de centrage réf. 8009030001.



g	Ref.	
3300	8004519001	1

## COFFRET DÉCOUPOIRS Ø 3 A 60 MM (PAIR)

- Tubes filetés Ø 3-4-6-8-10 mm.
- Tubes lisses Ø 12-14-16-18-20-22-24-26-28-30-32-34-36-38-40-42-44-46-48-50-52-54-56-58-60 mm.
- Bloc de centrage 3 à 60 mm réf. 8009040001.
- Manche de centrage 3 à 30 mm réf. 8008020001.
- Coupe joint Ø 500 mm réf. 8013050001.



g	Ref.	
6200	8004609001	1



## TUBES LISSES

De Ø 11 à 100 mm –  
permet de couper des matériaux tendres.



\* à la commande. Délai à confirmer.

Ø mm	Ref.	☐
11*	8005110001	1
12*	8005120001	1
13*	8005130001	1
14*	8005140001	1
15*	8005150001	1
16*	8005160001	1
17*	8005170001	1
18*	8005180001	1
19*	8005190001	1
20*	8005200001	1
21*	8005210001	1
22*	8005220001	1
23*	8005230001	1
24*	8005240001	1
25*	8005250001	1
26*	8005260001	1
27*	8005270001	1
28*	8005280001	1
29*	8005290001	1
30*	8005300001	1
31*	8005310001	1
32*	8005320001	1
33*	8005330001	1
34*	8005340001	1
35*	8005350001	1
36*	8005360001	1
37*	8005370001	1
38*	8005380001	1
39*	8005390001	1
40*	8005400001	1
41*	8005410001	1
42*	8005420001	1
43*	8005430001	1
44*	8005440001	1
45*	8005450001	1
46*	8005460001	1
47*	8005470001	1
48*	8005480001	1
49*	8005490001	1
50*	8005500001	1
51*	8005510001	1
52*	8005520001	1
53*	8005530001	1
54*	8005540001	1
55*	8005550001	1

Ø mm	Ref.	☐
56*	8005560001	1
57*	8005570001	1
58*	8005580001	1
59*	8005590001	1
60*	8005600001	1
61	8005610001	1
62	8005620001	1
63	8005630001	1
64	8005640001	1
65	8005650001	1
66	8005660001	1
67	8005670001	1
68	8005680001	1
69	8005690001	1
70	8005700001	1
71	8005710001	1
72	8005720001	1
73	8005730001	1
74	8005740001	1
75	8005750001	1
76	8005760001	1
77	8005770001	1
78	8005780001	1
79	8005790001	1
80	8005800001	1
81	8005810001	1
82	8005820001	1
83	8005830001	1
84	8005840001	1
85	8005850001	1
86	8005860001	1
87	8005870001	1
88	8005880001	1
89	8005890001	1
90	8005900001	1
91	8005910001	1
92	8005920001	1
93	8005930001	1
94	8005940001	1
95	8005950001	1
96	8005960001	1
97	8005970001	1
98	8005980001	1
99	8005990001	1
100	8005000001	1



## TUBES FILETÉS

De Ø 2 à 10 mm.



\* à la commande. Délai à confirmer.

Ø mm	Ref.	☐
2*	8007020001	1
3*	8007030001	1
4*	8007040001	1
5*	8007050001	1
6*	8007060001	1
7*	8007070001	1
8*	8007080001	1
9*	8007090001	1
10*	8007100001	1

## MANCHE DE CENTRAGE

Adaptable pour tous  
tubes filetés – tubes  
lisses de Ø 2 à 30 mm  
et bloc de centrage réf.  
8009020001.



Pour tubes filetés	Pour tubes lisses	Ref.	☐
Ø 2 - 10mm	Ø 11 - 20mm	8008010001	1
Ø 2 - 10mm	Ø 11 - 30mm	8008020001	1

## BLOC DE CENTRAGE

Adaptable pour tous tubes filetés et tubes lisses Ø 11 à 100 mm.



\* à la commande. Délai à confirmer.

Nb gradins	Pour tubes lisses	Ref.	☐
2 *	Ø 11-40 mm	8009020001	1
3 *	Ø 11-50 mm	8009030001	1
4 *	Ø 11-60 mm	8009040001	1
7	Ø 11-80 mm	8009070001	1
9	Ø 11-100 mm	8009090001	1

## COUPEAU À RONDELLE

Capacité Ø 300 à 1000 mm



Ø mm	Ref.	☐
300	8013030001	1
400	8013040001	1
500	8013050001	1
600	8013060001	1
800	8013080001	1
1000	8013100001	1



16



62



96



120



126



156



188



224



248



254



300



316



340



390



462



488



## COUTEAU À RONDELLE MANCHE BOIS

Capacité Ø 300 à 1000 mm.



Ø mm	Ref.	📦
300	8014030001	1
400	8014040001	1
500	8014050001	1
600	8014060001	1
800	8014080001	1
1000	8014100001	1

## LAME DE RECHANGE

Pour couteaux à rondelles.



L mm	Ref.	📦
90	8015010001	1

## EMPORTE-PIÈCE OUVERTURE LATÉRALE À FRAPPER

\* Certaines dimensions sont à la commande : commande séparée, soumise au franco et non annulable



Ø mm	Ref.	📦
2*	8017020001	1
3	8017030001	1
4	8017040001	1
5	8017050001	1
6	8017060001	1
7	8017070001	1
8	8017080001	1
9	8017090001	1
10	8017100001	1
11	8017110001	1
12	8017120001	1
13	8017130001	1
14	8017140001	1
15	8017150001	1
16	8017160001	1
17	8017170001	1
18	8017180001	1
19	8017190001	1
20	8017200001	1
21*	8017210001	1
22	8017220001	1
23*	8017230001	1
24	8017240001	1
25	8017250001	1

## JEU DE 9 EMPORTE-PIÈCES

Ø 2 à 10 mm.



9 pcs	Ref.	📦
	8017000001	1

## EMPORTE-PIÈCE À ARCHE



\* Certaines dimensions sont à la commande : commande séparée, soumise au franco et non annulable

Ø mm	Ref.	📦	Ø mm	Ref.	📦
14	8018140001	1	58*	8018580001	1
15	8018150001	1	59*	8018590001	1
16	8018160001	1	60	8018600001	1
17*	8018170001	1	61*	8018610001	1
18*	8018180001	1	62	8018620001	1
19*	8018190001	1	63	8018630001	1
20	8018200001	1	64	8018640001	1
21	8018210001	1	65	8018650001	1
22	8018220001	1	66	8018660001	1
23*	8018230001	1	67	8018670001	1
24	8018240001	1	68*	8018680001	1
25	8018250001	1	69*	8018690001	1
26*	8018260001	1	70	8018700001	1
27	8018270001	1	71*	8018710001	1
28*	8018280001	1	72*	8018720001	1
29*	8018290001	1	73*	8018730001	1
30	8018300001	1	74*	8018740001	1
31*	8018310001	1	75	8018750001	1
32	8018320001	1	76*	8018760001	1
33*	8018330001	1	77*	8018770001	1
34*	8018340001	1	78*	8018780001	1
35	8018350001	1	79*	8018790001	1
36	8018360001	1	80	8018800001	1
37*	8018370001	1	81	8018810001	1
38	8018380001	1	82*	8018820001	1
39*	8018390001	1	83	8018830001	1
40	8018400001	1	84*	8018840001	1
41	8018410001	1	85	8018850001	1
42*	8018420001	1	86*	8018860001	1
43	8018430001	1	87*	8018870001	1
44	8018440001	1	88	8018880001	1
45	8018450001	1	89*	8018890001	1
46	8018460001	1	90	8018900001	1
47*	8018470001	1	91*	8018910001	1
48	8018480001	1	92*	8018920001	1
49	8018490001	1	93*	8018930001	1
50	8018500001	1	94*	8018940001	1
51	8018510001	1	95	8018950001	1
52*	8018520001	1	96*	8018960001	1
53*	8018530001	1	97	8018970001	1
54	8018540001	1	98*	8018980001	1
55	8018550001	1	99*	8018990001	1
56*	8018560001	1	100*	8018000001	1
57*	8018570001	1			

# MACHINE À DÉCOUPER LES JOINTS



## MACHINE À DÉCOUPER LES JOINTS

### UTILISATION

- Pour un découpage précis de joints circulaires d'étanchéité industriels
- Permet la coupe de matières variées comme le cuir, le caoutchouc, les matières plastiques, le feutre, la fibre vulcanisée et le PTFE jusqu'à une épaisseur de 5 mm environ.
- Sa conception permet de découper, facilement et rapidement sans traçage, des joints dans une large plage de dimensions (60 à 1 240 mm)

### CARACTÉRISTIQUES

- Livré avec une mollette
- Ø 80 à 1250 mm

- 1 Manette d'abaissement de la molette
- 2 Molette de découpe
- 3 Réglette graduée correspondant au rayon (Rx2)
- 4 Manivelle de rotation de la molette pour la découpe du matériau
- 5 Axe de centrage de la rondelle

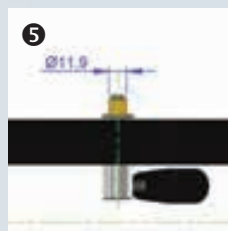
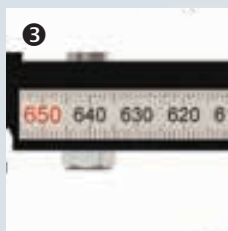
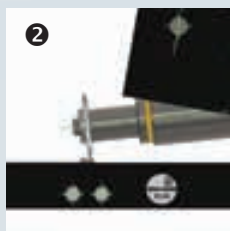

### MACHINE À DÉCOUPER LES JOINTS Ø 80 À 1250 MM

Épaisseur maximale des matériaux à découper : 5 mm suivant dureté.



g	Ref.	
8600	8001010001	1

### MOLETTE DE RECHANGE MACHINE À DÉCOUPER DE RECHANGE



Ref.	
8001020001	1









# MARTEAUX ET OUTILS FORGÉS

## MARTEAUX

**P.256**

**| MARTEAUX  
DE MÉCANICIEN**



**P.263**

**| MARTEAUX DE  
CHAUDRONNIER  
ET DE FORGE**



**P.264**

**| MARTEAUX  
ET TAS DE CARROSSIER**



**P.265**

**| MAILLETS ET  
MARTELLERIE TENDRE**



**P.283**

**| MANCHES  
ET COINS**



**P.271**

**| MARTEAUX  
D'ÉLECTRICIEN  
ET DE MENUISIER**



**P.273**

**| MASSES ET MASSETTES**



**P.276**

**| MARTEAUX DE COFFREUR,  
CHARPENTIER ET MAÇON**



**P.281**

**| HACHETTES ET HACHES  
MERLINS ET COINS**



**P.282**

**| AUTRES MARTEAUX  
DE MÉTIER**



## OUTILS FORGÉS

**P.285**

**| PARE-  
COUPS**



**P.286**

**| BURINS ET BÉDANES**



**P.287**

**| OUTILS  
À FRAPPER  
ET CHASSE-  
GOUILLES**



**P.289**

**| GRIFFE ET  
ÉQUERRE DE MAÇON**



**P.290**

**| BROCHES, CISEAUX,  
CHEVILLETES,  
SERRE-JOINTS**



**P.295**

**| OUTILS DE LEVAGE**

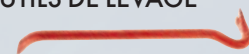



# LE CHOIX DU MANCHE



## MARTEAU MANCHE BOIS

### LES QUALITÉS DU BOIS

Le manche bois est apprécié dans l'industrie pour son confort et sa légèreté. C'est un matériau souple qui absorbe bien les chocs, et qui bénéficie d'un grip naturel.

Certains utilisateurs adaptent leur manche facilement (longueur, furet, prise en main, personnalisation...). Le frêne est utilisée pour les frappes légères à moyenne. L'hickory est plus dense, donc il casse beaucoup moins et est adapté aux frappes fortes.

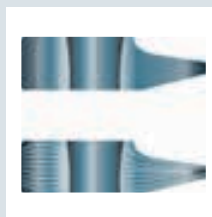

### L'EMMANCHEMENT BOIS

Les performances à l'arrachement sont beaucoup plus élevées que les normes et sont la marque de fabrique de MOB OUTILLAGE. Les manches bois sont séchés pour obtenir un taux d'humidité voisin de 11 %. Le manche est poussé par une machine hydraulique dans la tête, et un capteur d'effort mesure unitairement la puissance d'emmanchement. Depuis 2011, MOB utilise un nouveau coin plus performant et commun entre la France et l'Allemagne. La forme spécialement étudiée de ce coin permet de faire une pression sur le bois dans toutes les directions et lui interdit d'être éjecté lors des coups.

Le manche placé légèrement en retrait de la face supérieure du marteau, permet l'injection de résine polyuréthane. Cette résine assure un collage supplémentaire et surtout une étanchéité qui empêche les agents atmosphériques extérieurs de faire varier l'humidité du bois et donc d'empêcher les phénomènes de boitage du manche. Les propriétés élastiques de la résine lui permettent d'accompagner les déformations du bois lors des chocs sans casser. Un capteur de pression contrôle la mise en place de la résine.

### DOUBLE BAGUE SUR L'HICKORY

- une bague de protection contre les faux-coups
- une bague de protection contre les coups d'ajustage



## MARTEAU MANCHE COMPOSITE

L'innovation majeure du leader européen de la martellerie.

### FIBRE DE CARBONE ①

Les 2 ensembles de fibre de carbone transmettent la précision de la frappe sans nuire à l'absorption des vibrations. La fatigue est diminuée. La frappe reste sèche, facile et précise.

*Carbon*



### DOUBLE INTÉRÊT DE LA FIBRE DE VERRE : ②

- En longitudinal : résistance extrême à la flexion, élément anti-casse majeur
- En transversal : souplesse et adaptabilité, amortit le choc et absorbe une partie des vibrations.

L'élastomère sur toute la longueur du manche permet d'absorber les vibrations dès la base jusqu'à la main. Il permet de saisir le marteau sur toute sa longueur. Elastomère souple, texturé et nervuré, d'une fermeté «anti-ampoule».

### ERGONOMIE

L'ergonomie du Carbon est effective à la fois au moment du choc de la frappe et immédiatement après et préserve ainsi de la fatigue et des dangers liés à l'utilisation intensive de l'outil.

### QUALITÉ

Les qualités des matières font du Carbon un produit haut de gamme, à la fois précis, résistant, ergonomique et confortable. Sans doute le meilleur marteau au monde.

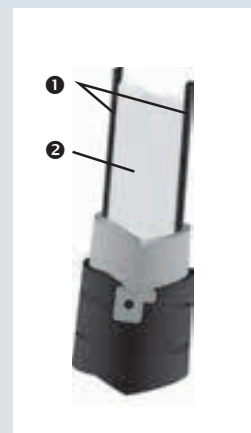

16



62



96



120



126



156



188



224



248



254



300



316



340



390



462



488



# MARTEAUX DE MÉCANICIEN



## LE MARTEAU RIVOIR DE MÉCANICIEN : REBOND FACILE

### CONFORT ET ERGONOMIE

- Choc net bien contrôlé qui n'entraîne aucun mouvement discordant qui affecterait l'outil ou l'objet frappé.
- Equilibre mais dissymétrie de l'outil par rapport à l'œil pour éviter tout ventre de vibration au niveau de l'œil qui se répercuterait le long du manche.



Le croquis montre que la disposition de la panne "p" se dégage en retrait vers le manche et ramène ainsi le centre de gravité "G" en arrière du centre de percussion "R" et un peu vers le bas. Le couple développé par le choc a donc un rayon de giration "GR" qui tend à relever le marteau, d'où un rebond favorable qui diminue l'effort de levage de la masse.

### MARTEAU RIVOIR DE MÉCANICIEN MANCHE CARBON

Modèle français.  
Quadrimatière.  
Voir page précédente.



C mm	B mm	A mm	g	L mm	Ref.	☐
22	17	74	160	262	0001220701	5
24	19	77	200	264	0001240701	5
26	21	80	250	266	0001260701	5
28	22	86	315	290	0001280701	5
30	24	92	400	292	0001300701	5
32	26	100	500	322	0001320701	5
36	29	103	630	326	0001360701	5
40	33	110	800	330	0001400701	5
42	34	117	1000	332	0001420701	5

### MARTEAU RIVOIR DE MÉCANICIEN MANCHE LE ROUGE

Modèle français.  
Trimatière.



C mm	B mm	A mm	g	L mm	Ref.	☐
26	21	80	250	266	0001260A01	5
30	24	92	400	292	0001300A01	5
36	29	103	630	326	0001360A01	5
40	33	110	800	330	0001400A01	5
42	34	117	1000	332	0001420A01	5

### MARTEAU RIVOIR DE MÉCANICIEN MANCHE HICKORY

Modèle français.  
Hickory américain véritable.



C mm	B mm	A mm	g	L mm	Ref.	☐	Coin	☐
22	17	74	160	250	0001220301	6640	10	5
24	19	77	200	260	0001240301	6602	11	5
26	21	80	250	260	0001260301	6602	11	5
28	22	86	315	280	0001280301	6603	11	5
30	24	92	400	280	0001300301	6604	12	5
32	26	100	500	300	0001320301	6605	14	5
36	29	103	630	300	0001360301	6606	15	5
40	33	110	800	330	0001400301	6607	16	5
42	34	117	1000	330	0001420301	6608	16	5

### MARTEAU RIVOIR DE MÉCANICIEN MANCHE FRÊNE

Modèle français.  
Manche frêne PEFC.



C mm	B mm	A mm	g	L mm	Ref.	☐	Coin	☐
18	14	68	100	250	0001180201	6800	08	5
22	17	74	160	250	0001220201	6800	10	5
24	19	77	200	260	0001240201	6801	11	5
26	21	80	250	260	0001260201	6801	11	5
28	22	86	315	280	0001280201	6802	11	5
30	24	92	400	280	0001300201	6803	12	5
32	26	100	500	300	0001320201	6804	14	5
36	29	103	630	300	0001360201	6805	15	5
40	33	110	800	330	0001400201	6806	16	5
42	34	117	1000	330	0001420201	6807	17	5



## MARTEAU PROTECT LE MARTEAU RENFORCÉ AVEC DOUILLE PARE FAUX-COUPS

### LE PLUS PRODUIT

- Robustesse
- Longévité
- Confort



**UN SAVOIR-FAIRE UNIQUE :**  
la douille métallique insérée dans la tête lors de l'emmanchement, la traverse entièrement, Cela lui assure une tenue inaltérable



### ROBUSTESSE ET LONGÉVITÉ

- Le manche bois Hickory a de nombreux avantages : confort parfait, souplesse... mais il peut s'abîmer lors des faux coups. La solution innovante de Mob est une douille métallique pare faux-coups. Inaltérable, elle permet de prolonger la durée de vie du marteau.

### NOUVEAU MADE IN FRANCE

Ce marteau est forgé et emmanché dans notre usine du Chambon Feugerolles dans la Loire avec un savoir-faire unique.



### SÉCURITÉ OPTIMALE

- La douille n'est pas une simple bague ajoutée sous la tête : elle traverse la tête et est emmanchée au même moment que le manche, ce qui garantit une résistance à l'emmanchement optimale et une douille indélogeable.

### CARACTÉRISTIQUES

- Douille en acier à haute teneur en Carbon, finition chrome.
- Douille traversante visible sur le dessus. Coin rond acier.
- Emmanchement hydraulique avec capteur de contrôle de la pression.

### FABRICATION

- Ce marteau est entièrement réalisé dans notre usine du Chambon dans la Loire avec un savoir-faire unique.



## MARTEAU RIVOIR DE MÉCANICIEN PROTECT

Modèle français.

Manche Hickory avec douille pare faux-coups en acier.



C mm	B mm	A mm	g	L mm	Ref.		Coin	
32	26	100	500	300	0001329301	6675050301	11	5
36	29	103	630	300	0001369301	6675060301	12	5
40	33	110	800	330	0001409301	6675080301	12	5



16



62



96



120



126



156



188



224



248



254



300



316



340



390



462



488



599



# MARTEAUX À MAIN

## MARTEAU RIVOIR SÉCURIPLUS

Traitement thermique intense - dureté 50 à 58 Hrc au centre de la zone de frappe.



C mm	B mm	A mm	L mm	▲ g	Ref.		Coin	
40	33	110	315	800	0009400301	6607	16	1
55	44	142	380	2000	0009550301	6610	18	1



## MARTEAU À MAIN

### PUISSANCE

Le marteau à main est un rivoir de poids élevé. Utilisé au départ par les mécaniciens, qui recherchent à la fois de la puissance et de la précision. Les arrêtes sont néanmoins chanfreinées de façon plus marquée pour éviter tout risque d'éclat.

### CARACTÉRISTIQUES

Tête en acier à forte teneur en carbone C45E. Tête forgée, avec traitement thermique par induction des surfaces travaillantes (54 HRC). Parties travaillantes finement polies. Peinture poudre époxydique par procédé électrostatique, suivi d'une cuisson au four. Chanfrein de 1/20e de la tête à 45°. Panne en travers.

### MANCHE

Emmancement réalisé par une machine hydraulique, un capteur d'effort mesure sur chaque produit unitairement la puissance d'emmanchement, puis un capteur de pression contrôle la mise en place de la résine. Les performances à l'arrachement sont beaucoup plus élevées que les normes et sont la marque de fabrique de MOB outillage.

3 manches proposés :

- Frêne, léger et économique,
- Hickory, bois dense et absorbant les vibrations
- Manche composite incassable Carbon quadri-matière, avec une âme incassable en fibre de verre et 2 barreaux de fibre de carbone, du polypropylène anti-vibration et une surinjection en élastomère pour le grip. Frappe sèche et précise.



Injection de résine PU



## MARTEAU À MAIN MANCHE FRÊNE

Panne en travers.



C mm	B mm	A mm	▲ g	L mm	Ref.		Coin	
45	36	128	1250	350	0002450201	6808	17	1
50	40	138	1500	350	0002500201	6808	18	1
55	44	142	2000	380	0002550201	6809	18	1
60	48	150	2500	380	0002600201	6809	18	1

## MARTEAU À MAIN MANCHE HICKORY

Panne en travers.



C mm	B mm	A mm	▲ g	L mm	Ref.		Coin	
45	36	128	1250	350	0002450301	6609	17	1
50	40	138	1500	350	0002500301	6609	18	1
55	44	142	2000	380	0002550301	6610	18	1
60	48	150	2500	380	0002600301	6610	18	1

## MARTEAU À MAIN MANCHE CARBON

Panne en travers.



C mm	B mm	A mm	▲ g	L mm	Ref.	
45	36	128	1250	365	0002450701	1
50	40	138	1500	370	0002500701	1
55	44	142	2000	375	0002550701	1

## MARTEAU À MAIN MANCHE HICKORY

Panne en long.



C mm	B mm	A mm	L mm	▲ g	Ref.		Coin	
43	43	128	330	1250	0003120301	6608	16	1
45	45	138	350	1500	0003150301	6609	17	1
50	50	142	380	2000	0003200301	6610	18	1

# MARTEAUX DE MÉCANICIEN



## MARTEAU EUROPE CENTRALE MANCHE FRENE

Rivoir allemand.  
DIN 1041.



A mm	C mm	g	L mm	Ref.	⌘	Coin	📦
105	23	300	280	0402030201	6802	11	5
112	25	400	300	0402040201	6804	14	5
118	27	500	300	0402050201	6804	14	5
122	29	600	300	0402060201	6805	15	5
130	33	800	315	0402080201	6806	16	1
135	36	1000	330	0402100201	6807	17	1
145	42	1500	350	0402150201	6808	17	1
155	47	2000	380	0402200201	6809	18	1

## MARTEAU EUROPE CENTRALE MANCHE HICKORY

Rivoir allemand.  
DIN 1041.  
Pas de bague de protection  
à partir de 3kg.



A mm	C mm	g	L mm	Ref.	⌘	Coin	📦
105	23	300	280	0402030301	6603	11	5
118	27	500	300	0402050301	6605	14	5
122	29	600	300	0402060301	6606	15	5
130	33	800	315	0402080301	6607	16	1
135	36	1000	330	0402100301	6608	16	1
145	42	1500	350	0402150301	6609	17	1
155	47	2000	380	0402200301	6610	18	1
160	56	3000	700	0402300301	6667	16x2	1
174	62	4000	800	0402400301	6668	17x2	1
184	68	5000	900	0402500301	6669	18x2	1
194	72	6000	900	0402600301	6669	18x2	1
212	80	8000	1000	0402800301	6670	18x2	1
226	86	10000	1000	0402910301	6670	18x2	1

## MARTEAU EUROPE CENTRALE MANCHE CARBON

Rivoir allemand.



A mm	C mm	Norme	g	L mm	Ref.	📦
95	19	DIN 1041	200	259	0402020701	5
105	23	DIN 1041	300	285	0402030701	5
112	25	DIN 1041	400	287	0402040701	5
118	27	DIN 1041	500	317	0402050701	5
122	29	DIN 1041	600	319	0402060701	5
130	33	DIN 1041	800	323	0402080701	5
135	36	DIN 1041	1000	326	0402100701	5
145	42	DIN 1041	1500	362	0402150701	1
155	47	DIN 1041	2000	367	0402200701	1

Emmancement conique Nertech

A mm	C mm	Norme	g	L mm	Ref.	📦
160	56	DIN 1042	3000	900	0402310801	1
174	62	DIN 1042	4000	900	0402410801	1
184	68	DIN 1042	5000	900	0402510801	1

## MARTEAU ANGLAIS

À boule.



lb	B1 mm	B mm	A mm	L mm	g	Ancienne Ref.	Ref.	📦
1/2	21	24	83	290	225	0420020201	5081030500	1
1	26	30	103	340	450	0420040201	5081031000	1
2	33	38	125	390	900	0420090201	5081032000	1

## MARTEAU À PIQUER LES SOUDURES MANCHE FRENE



A mm	B mm	C mm	g	L mm	Ref.	⌘	Coin	📦
175	20	22	300	280	0430300201	6802	11	1
185	22	24	400	280	0430400201	6803	12	1
200	23	25	500	300	0430500201	6804	14	1
215	24	26	600	300	0430600201	6805	15	1

## MARTEAU À PIQUER LES SOUDURES MANCHE HICKORY



A mm	B mm	C mm	g	L mm	Ref.	⌘	Coin	📦
175	20	22	300	280	0430300301	6603	11	1
185	22	24	400	280	0430400301	6604	12	1
200	23	25	500	300	0430500301	6605	14	1
215	24	26	600	300	0430600301	6606	15	1

## MARTEAU À PIQUER LES SOUDURES MANCHE CARBON



A mm	B mm	C mm	g	L mm	Ref.	📦
185	22	24	400	286	0430400701	1

## MARTEAU À PIQUER MANCHE HICKORY



Effilé.



A mm	B mm	L mm	g	Ref.	⌘	Coin	📦
250	20	280	350	0469350301	6604	12	1

## MARTEAU À PIQUER LES CHAUDIÈRES MANCHE HICKORY



A mm	B mm	C mm	g	Ref.	📦
165	24	22	300	5097020000	1





# MARTEAUX À GARNIR



## MARTEAU À GARNIR

Utilisé au départ par les chaudronniers, pour donner une forme aux tôles.

- Tête en acier à forte teneur en carbone C45E, forgée, avec traitement thermique par induction des surfaces travaillantes (54 HRC).
- Tête ronde, bombée, finement polie, y compris sur la circonférence extérieure. Peinture poudre époxydique par procédé électrostatique, suivi d'une cuisson au four.



## MARTEAU À GARNIR MANCHE HICKORY

Tête ronde.



B mm	A mm	g	L mm	Ref.	Coil	Coin	Box
18	95	100	250	0200180301	6640	08	1
22	102	160	260	0200220301	6602	09	1
26	112	250	280	0200260301	6603	11	1
28	116	315	280	0200280301	6603	11	1
30	121	400	280	0200300301	6604	12	1
32	132	500	300	0200320301	6605	13	1
36	137	630	300	0200360301	6606	13	1
40	147	800	315	0200400301	6607	15	1
45	157	1250	350	0200450301	6609	17	1
50	162	1500	350	0200500301	6609	17	1
60	175	2500	800	0200600301	6667	16x2	1

## MARTEAU À GARNIR PROTECT

Tête rond.  
Manche Hickory.  
Douille pare faux-coups en acier traversante.



B mm	A mm	g	L mm	Ref.	Coil	Coin	Box
28	116	315	280	0200289301	6675030301	08	1

## MARTEAU À GARNIR MANCHE CARBON

Tête ronde.



B mm	A mm	g	L mm	Ref.	Box
22	102	160	262	0200220701	1
28	116	315	290	0200280701	1
32	132	500	322	0200320701	1
36	137	630	326	0200360701	1
40	147	800	330	0200400701	1
50	162	1500	370	0200500701	1

## MARTEAU À GARNIR ALLONGÉ MANCHE HICKORY

Tête carrée de 28.



B mm	A mm	L mm	g	Ref.	Coil	Coin	Box
28	140	280	400	0298000301	6604	12	1

## MARTEAU PANNES OPPOSÉES MANCHE HICKORY

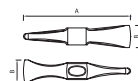

B mm	A mm	L mm	g	Ref.	Coil	Coin	Box
30	145	280	400	0355000301	6603	11	1

## MARTEAU À PLANER MANCHE HICKORY

Têtes rondes :  
1 plate - 1 bombée.



B mm	A mm	L mm	g	Ref.	Coil	Coin	Box
30	105	280	400	0204300301	6604	12	1
40	126	315	800	0204400301	6607	15	1
50	145	350	1500	0204500301	6609	17	1
60	160	700	3000	0204600301	6667	16x2	1

## MARTEAU POSTILLON MANCHE HICKORY

1 tête ronde.  
1 tête carrée.



B mm	A mm	L mm	g	Ref.	Coil	Coin	Box
22	85	260	160	0213220301	6602	09	2
26	95	280	250	0213260301	6603	11	2
28	100	280	315	0213280301	6603	11	2
30	105	280	400	0213300301	6604	12	2
36	120	300	630	0213360301	6606	15	2
40	126	315	800	0213400301	6607	15	2

## MARTEAU À EMBOUTIR MANCHE HICKORY



B mm	A mm	L mm	g	Ref.	Coil	Coin	Box
26	120	280	250	0208260301	11	6603	1
30	130	280	400	0208300301	12	6604	1
36	140	300	630	0208360301	15	6606	1





## MARTEAU À RETREINDRE



B mm	C mm	A mm	L mm	g	Ref.	Cl.	Coin	Boîte
30	16	130	280	400	0209300301	6604	12	1

## TRANCHE À FROID MANCHE HICKORY



A mm	C mm	R mm	X mm	Y mm	L mm	g	Ref.	Cl.	Coin	Boîte
185	33	15	80	6	350	1500	0006150301	6609	17	1

## TRANCHE À CHAUD MANCHE HICKORY



					Hickory				
A mm	C mm	X mm	L mm	g	Ref.	Cl.	Coin	Boîte	
185	33	90	350	1500	0007150301	6609	17	1	

## POINÇON À ŒIL MANCHE HICKORY

DIN 5253.



Ø mm	g	Ancienne Ref.	Ref.	Boîte
10	800	0012100301	5056020010	1
20	1900	0012200301	5056020020	1

## TRANCHET D'ENCLUME



A mm	B mm	C mm	g	Ancienne Ref.	Ref.	Boîte
135	23-25	50	1150	0021070601	5058010000	1

## TENAILLES DE FORGE

### TENAILLE DE FORGE

Standard.

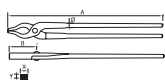

A mm	B mm	Ø mm	g	Ref.	Boîte
500	88	14	1400	0031500601	1
600	95	14	2000	0031600601	1

### TENAILLE DE FORGE

Plate ouverte.



A mm	B mm	C mm	Ø mm	g	Ref.	Boîte
300	80	7	11	800	0032300601	1
400	90	9	13	1200	0032400601	1
500	100	10	14	1400	0032500601	1
600	110	16	14	2000	0032600601	1

### TENAILLE DE FORGE

À rivets.

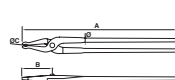

A mm	B mm	Ø mm	g	Ref.	Boîte
500	100	14	1400	0036500601	1

### TENAILLE DE FORGE

À bouterolle.

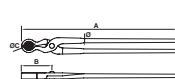

A mm	B mm	Ø mm	g	Ref.	Boîte
500	100	14	1400	0037500601	1

### TENAILLE DE FORGE

Coquilles carrées.

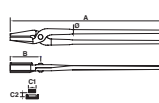

A mm	B mm	C1x2 mm	Ø mm	g	Ref.	Boîte
500	100	11x23	14	1400	0041500601	1

### TENAILLE DE FORGE

Coquilles rondes.

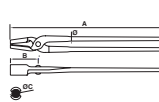

A mm	B mm	Ø mm	g	Ref.	Boîte
300	70	10,5	800	0034300601	1
400	80	13	1200	0034400601	1

### TENAILLE DE FORGERON

Universelle.

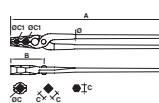

Ø mm	A mm	B mm	C1 mm	C mm	g	Ref.	Boîte
11	300	80	8	8	800	0047300601	1
13	400	90	10	10	1200	0047400601	1
14	500	110	15	15	1400	0047500601	1
14	600	130	20	15	2000	0047600601	1





# MARTEAUX ET TAS DE CARROSSIER

## MARTEAU POSTILLON MANCHE HICKORY

Modèle court.



C mm	B mm	A mm	L mm	g	Ref.	✂	Coin	📦
25	30	105	280	360	0311000301	6603	11	1

## MARTEAU POSTILLON MANCHE HICKORY

1 tête ronde quadrillée.  
1 tête carrée pièce fine.  
(existe en 40/35 sur demande)



B mm	C mm	A mm	L mm	g	Ref.	✂	Coin	📦
35	30	105	280	360	0347000301	6603	11	1

## BATTE À PLANER MANCHE HICKORY

Tête plate quadrillée.



C mm	B mm	A mm	L mm	g	Ref.	✂	Coin	📦
50	30	65	280	200	0376100301	6603	11	1

## BATTE À PLANER MANCHE HICKORY

Tête plate.



C mm	B mm	A mm	L mm	g	Ref.	✂	Coin	📦
50	30	65	280	200	0300100301	6603	11	1
60	40	80	280	350	0300200301	6603	11	1

## BATTE À PLANER MANCHE HICKORY

Tête bombée en large.

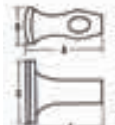

C mm	B mm	A mm	L mm	g	Ref.	✂	Coin	📦
50	30	65	280	200	0301100301	6603	11	1

## BATTE À PLANER MANCHE HICKORY

Tête bombée en long.



C mm	B mm	A mm	L mm	g	Ref.	✂	Coin	📦
50	30	65	280	200	0308100301	6603	11	1

## MARTEAU À DÉBOSSÉLER MANCHE HICKORY

Panne droite.



B mm	C mm	C1 mm	A mm	L mm	g	Ref.	✂	Coin	📦
40	8,5	20	140	280	300	0313300301	6603	11	1

## MARTEAU À DÉBOSSÉLER MANCHE HICKORY

Panne cintrée.



B mm	C mm	C1 mm	A mm	L mm	g	Ref.	✂	Coin	📦
43	8	20	160	280	350	0314350301	6603	11	1

## MARTEAU À FORCE ROTATRICE MANCHE HICKORY



B mm	C mm	A mm	L mm	g	Ancienne Ref.	Ref.	✂	📦
42	32	115	280	300	0384000301	0160530000	6603	1

## COFFRET DE TÔLIER

- 10 outils :
- tas américain
  - table plate
  - fer à cheval
  - tas diabolo
  - tas épinçoir
  - marteau rivoir de 32
  - marteau à garnir - allongé
  - batte à planer - plate 50 x 30
  - marteau postillon - corps rond
  - maillet plastique
  - monture à arc



10 pcs	LxPxH cm	g	Ref.	📦
	48 x 22,5 x 12,5	10 kg	0391100701	1



## TABLE PLATE

« Fer à cheval ».



B mm	C mm	A mm	D mm	g	Ref.	📦
95	75	100	23	1000	0290100601	1
105	78	120	23	1410	0290200601	1

## TAS AMERICAIN



A mm	B mm	C mm	g	Ref.	📦
82	60	34	1000	0281000601	1

## TAS ALLÉGÉ "DÉTROIT"

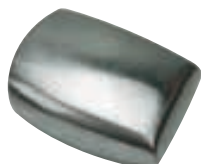

A mm	B mm	C mm	g	Ref.	📦
85	55	25	800	0374000601	1

## TAS ÉPINÇOIR



A mm	B mm	C mm	g	Ref.	📦
125	65	37	1270	0304000601	1

## CUILLÈRE ÉTROITE



C mm	B mm	A mm	D mm	E mm	g	Ref.	📦
180	34	310	22	10	825	0321000601	1

## CUILLÈRE LARGE



C mm	B mm	A mm	D mm	E mm	g	Ref.	📦
140	50	250	23	8	795	0322000601	1

## MAILLETS ET MARTEAUX



## MASSETTE CUIVRE

- Utilisée dans l'industrie pour frapper sans abîmer les pièces.

Densité : 8.9g/cm<sup>3</sup>



### TÊTE

- Tête 100% cuivre désoxydé au phosphore, forgée pour plus de résistance.
- Propriétés : conducteur, antidéflagrant.
- Tête chanfreinée à 45°. Angles abattus.

Attention : le cuivre étant une matière malléable, sa durée de vie est limitée et ses déformations importantes.

Ne plus utiliser dès que le manche commence à se déchausser.  
Une oxydation de surface est normale, elle n'altère pas les qualités du produit.



## MASSETTE CUIVRE MANCHE FRÈNE



Tête forgée 100 % cuivre.



B mm	A mm	g	L mm	Ref.	🔪	Coin	📦
25	75	400	300	0365040201	6804	14	1
30	82	600	300	0365060201	6805	15	1
34	86	750	315	0365070201	6806	16	1
36	91	1000	330	0365100201	6807	16	1
43	100	1500	350	0365150201	6808	17	1

## MASSETTE CUIVRE MANCHE HICKORY



Tête forgée 100 % cuivre.



B mm	A mm	g	L mm	Ref.	🔪	Coin	📦
25	75	400	300	0365040301	6605	14	1
30	82	600	300	0365060301	6606	15	1
34	86	750	315	0365070301	6607	16	1
36	91	1000	330	0365100301	6608	16	1
43	100	1500	350	0365150301	6609	17	1

## MASSETTE CUIVRE MANCHE CARBON



Tête forgée 100 % cuivre.



B mm	A mm	g	L mm	Ref.	📦
30	82	600	320	0365060701	1
36	91	1000	326	0365100701	1
42	108	1500	363	0365150701	1



16



62



96



120



126



156



188



224



248



254



300



316



340



390



462



488



# MAILLETS ET MARTELLERIE TENDRE



## MAILLET EN BOIS LAMELLÉ FRETTÉ DYNACHOC

Le savoir-faire de MOB a été intégré suite à l'acquisition de la société Dynachoc en 1999. Spécialiste de la frappe "soft", Dynachoc présentait des savoir-faire complémentaires à ceux de MOB. Le nom "Dynachoc" perdure au travers de sa gamme phare de maillets lamellés-frettés.



### DENSITÉ ÉLEVÉE ET HOMOGENÈME

1 La tête est réalisée en bois lamellé-collé, particulièrement stable. Réputé pour sa très grande résistance mécanique (flexion, compression, torsion), il présente une rectitude et une homogénéité supérieure au bois massif.

### FRETTAGE

2 Deux ensembles de fibre de verre ceinturent la masse en bois, assurant le maintien des couches croisées lors des frappes fortes et intensives, pour une longévité optimisée. Les fibres sont colorées en vert pour signaler leur présence.

### QUALITÉ

- 3 Manche en Hickory.
- 4 Assemblage autobloquant.

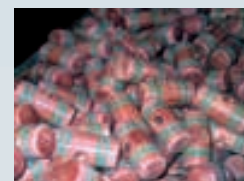

Tannage et frettage réalisés au Chambon.

### MAILLET FORME TONNEAU DYNACHOC

En bois comprimé avec frettage encastré en fibre de verre - Manche hickory.

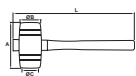

B mm	C mm	A mm	L mm	g	Ref.		
40	30	85	260	155	0330040301	6821000301	1
50	30	100	300	330	0330050301	6821010301	1
60	45	125	325	540	0330060301	6821020301	1
70	50	145	365	790	0330070301	6821030301	1
80	60	165	390	1115	0330080301	6821040301	1
100	75	195	425	1935	0330100301	6821050301	1

### MAILLET FORME À EMBOUTIR DYNACHOC

En bois comprimé avec frettage encastré en fibre de verre - Manche hickory.

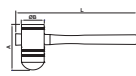

B mm	A mm	L mm	g	Ref.		
60	120	320	500	0331060301	6821020301	1
100	195	425	1900	0331100301	6821050301	1

### MAILLET FORME CAROTTE DYNACHOC

En bois comprimé avec frettage encastré en fibre de verre - Manche hickory.

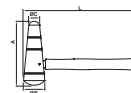

B mm	C mm	A mm	L mm	g	Ref.		
40	30	190	290	350	0332030301	6821060301	1
55	27	150	290	400	0332027301	6821060301	1

### CHASSE DYNACHOC

En bois comprimé avec frettage encastré en fibre de verre.

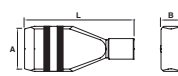
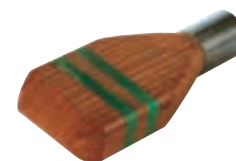

B mm	A mm	L mm	g	Ref.		
30	70	170	380	0398030001		1



## MASSETTE SANS REBOND

### FRAPPE

- Effet sans rebond
- Tête partiellement remplie de billes d'acier.
- Effet d'inertie lors de la frappe.
- Dureté faible : A86.
- Limite le risque d'éclat des pièces métalliques frappées.

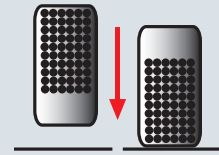

### SURMOULAGE INTÉGRAL

- Surmoulé en NBR Nitrile Rubber, résistant de -20°C à +90°C.
- Evite la rupture de la tête et l'échappement des billes.

### UTILISATION

- Montage, assemblage, positionnement de pièces.
- Idéal pour les phases d'ajustage précis.



### MASSETTE SANS REBOND

Tête remplie de billes d'acier.  
Corps en acier. Intégralement enrobé de NBR.

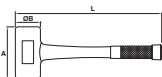

B mm	A mm	L mm	g	Ref.	☐
30	105	280	270	0375300001	1
35	90	280	385	0375350001	1
45	90	300	620	0375450001	1
50	100	320	860	0375500001	1
60	110	370	1340	0375600001	1

### MAILLET SANS REBOND

Tête carrée angles abattus, remplie de billes d'acier, enrobée de NBR.  
Corps en acier. Manche en fibre de verre, poignée élastomère.

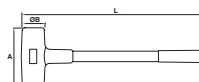

B mm	A mm	L mm	g	Ref.	☐
100	160	900	5500	0375910001	1



16



62



96



120



126



156



188



224



248



254



300



316



340



390



462



488



267



# MAILLETS ET MARTELLERIE TENDRE



## MAILLET SANS RECUL

### UTILISATION

- Dans les opérations d'ajustage, il est souvent important de privilégier la précision, et la suppression de l'effet rebond est alors recherchée.

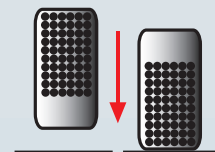

### PRINCIPE

- La tête de massette contient des billes d'acier.  
- Au moment du choc, le principe d'inertie plaque les billes vers le bas et compense la force du rebond.

### EMBOUS

- Embouts TPU : polyuréthane thermoplastique - dureté 65D.  
- Aucun risque d'éclat sur des surfaces dures. Pas de marque.

### MAILLET SANS RECUL A EMBOUS INTERCHANGEABLES

Embouts TPU : polyuréthane thermoplastique.  
Dureté 65D.  
Manche tubulaire.

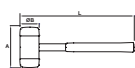

Ø mm	g	Acier tubulaire		Embouts	
		Ref.	Q	Ref.	Q
35	600	5135050035	1	5135150035	2
40	800	5135050040	1	5135150040	2
50	1120	5135050050	1	5135150050	2
60	1700	5135050060	1	5135150060	2

### MAILLET SANS RECUL A EMBOUS INTERCHANGEABLES

Tête de massette remplie de billes d'acier. Embouts TPU : polyuréthane thermoplastique.  
Dureté 65D. Manche bois.

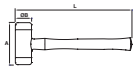

B mm	A mm	L mm	g	Hickory		Embouts		
				Ref.	Q	Ancienne Ref.	Ref.	Q
30	105	345	440	0370300301	1	0370030001	5135150030	2
35	110	350	560	0370350301	1	0370035001	5135150035	2
40	120	370	730	0370400301	1	0370040001	5135150040	2
50	125	380	1080	0370500301	1	0370050001	5135150050	2
60	139	410	1750	0370600301	1	0370060001	5135150060	2

### MAILLET À EMBOUS INTERCHANGEABLES

Manche tubulaire  
Poignée caoutchouc.  
Embouts TPU : polyuréthane thermoplastique.  
Dureté 65D.

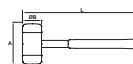

B mm	A mm	L mm	g	Acier tubulaire		Embouts		
				Ref.	Q	Ancienne Ref.	Ref.	Q
28	77	268	380	0352280510	1			
35	100	318	700	0352350510	1	0370035001	5135150035	2
40	110	323	900	0352400510	1	0370040001	5135150040	2
50	115	328	1150	0352500510	1	0370050001	5135150050	2

### EMBOUS INTERCHANGEABLES POUR MAILLET

Embouts TPU : polyuréthane thermoplastique.  
Dureté 65D.



B mm	Pour ref.		Embouts		
	Ancienne Ref.	Ref.	Ancienne Ref.	Ref.	Q
30	0370300301		0370030001	5135150030	2
35	0370350301 - 5135050035 - 0352350510		0370035001	5135150035	2
40	0370400301 - 5135050040 - 0352400510		0370040001	5135150040	2
50	0370500301 - 5135050050 - 0352500510		0370050001	5135150050	2
60	0370600301 - 5135050060		0370060001	5135150060	2



## MASSETTE À EMBOUTS 2 DURETÉS

### DOUBLE DURETÉ

- 2 embouts montés par défaut : 1 embout nylon durété 75D et 1 embout acétate de cellulose durété 68D.



### MANCHE ET CORPS

- Corps en aluminium, manche frêne issu de forêts gérées durablement (PEFC).  
- Qualité Made in Germany.

### CHANGEMENT D'EMBOUS

- Après la casse de l'ancien embout, le nouvel embout se monte par simple frappe.

## MASSETTE À EMBOUTS 2 DURETÉS

Manche frêne.  
Corps aluminium.  
1 embout nylon durété 75D.  
1 embout acétate de cellulose durété 68D.



			Marteau manche frêne		jeu de 2 embouts Acétate		jeu de 2 embouts Nylon	
ØD mm	L mm	g	Ref.	Ref.	Ref.	Ref.	Ref.	
25	270	215	0377250201	0377251001	0377252001	0377252001	0377252001	
30	280	280	0377300201	0377301001	0377302001	0377302001	0377302001	
40	325	510	0377400201	0377401001	0377402001	0377402001	0377402001	
50	340	940	0377500201	0377501001	0377502001	0377502001	0377502001	

## MAILLET NYLON

Manche frêne.

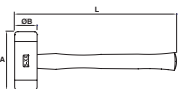

B mm	A mm	L mm	g	Ref.	Ref.
27	85	270	220	0371270201	1
32	95	290	310	0371320201	1
35	100	290	370	0371350201	1
40	105	320	540	0371400201	1
50	120	340	860	0371500201	1

## MASSETTE CORPS ACIER LOURD

Avec embouts en plastique vissés « Vistaflex ».  
Manche frêne.

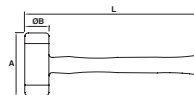

				Frêne			Embouts / Tips	
B mm	A mm	L mm	g	Ref.	Coin	Ref.	Ref.	
35	95	285	410	0395035201	11	0396035610	2	
42	100	330	580	0395042201	15	0396042610	2	

## MAILLET PLASTIQUE

Tête bombée.  
Embouts Cellulose-Acétate D69.  
Manche frêne.

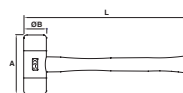

B mm	A mm	L mm	g	Ref.	Ref.
22	70	255	140	0369220201	1
27	85	270	220	0369270201	1
32	95	290	330	0369320201	1
35	100	290	400	0369350201	1
40	105	320	550	0369400201	1
50	120	340	880	0369500201	1



16



62



96



120



126



156



188



224



248



254



300



316



340



390



462



488



269



# MAILLETS ET MARTELLERIE TENDRE

## MAILLET EN PEAU DE BUFFLE



B mm	A mm	L mm	g	Ref.	☐
38	82	260	170	0380038201	1
50	90	300	330	0380050201	1
63	110	360	520	0380063201	1
70	116	360	670	0380070201	1
76	135	390	850	0380076201	1
89	140	390	1160	0380089201	1

## MAILLET BOIS

Entièrement en bois naturel.



B mm	C mm	A mm	L mm	g	Ref.	☐
40	35	80	250	120	0368400201	3
50	41	100	280	195	0368500201	3
60	50	120	315	335	0368600201	3
70	55	140	350	490	0368700201	3
80	65	160	380	695	0368800201	3
100	82	200	470	1435	0368910201	1

## MAILLET DE SCULPTEUR

Entièrement en bois naturel.



A mm	C mm	L mm	g	Ref.	☐
80	38	240	505	0343000010	1

## MAILLET DE MENUISIER

Pour la frappe de ciseaux de sculpteur

- Le bois n'abîme pas les manches de ciseau.
- Le poids (750g) apporte de la puissance.
- La grande surface de frappe permet de se concentrer sur le travail du tranchant du ciseau (l'utilisateur ne surveille plus l'arrière du manche de peur de se taper sur les doigts).

Entièrement en bois.



C mm	B mm	A mm	L mm	g	Ref.	☐
100	68	100	300	750	0337750201	1

## MAILLET CAOUTCHOUC TENDRE

Tête caoutchouc qualité tendre, légèrement bombée. Manche en frêne FSC.



B mm	C mm	A mm	L mm	g	Ref.	☐
55	50	90	290	300	0348055201	3
65	60	110	320	450	0348065201	3
75	70	120	370	650	0348075201	3

## MAILLET CAOUTCHOUC DUR

Tête caoutchouc dur 90 shores, légèrement bombée. Manche en frêne FSC.



B mm	C mm	A mm	L mm	g	Ref.	☐
40	35	75	270	150	0367400201	3
50	50	90	290	350	0367500201	3
60	60	110	320	550	0367600201	3
70	70	120	370	750	0367700201	3
90	90	130	370	1120	0367900201	3

## MAILLET CAOUTCHOUC FORME CARRELEUR NOIR

Un côté rond, un côté plat. Manche en frêne FSC.



B mm	C mm	A mm	L mm	g	Ref.	☐
65	60	110	330	500	0346650201	3
90	80	140	370	1100	0346900201	3

## MAILLET CAOUTCHOUC FORME CARRELEUR BLANC

Un côté rond, un côté plat. Manche en frêne FSC.



B mm	C mm	A mm	L mm	g	Ref.	☐
65	50	110	330	500	0346652201	3

## MAILLET BÉTONNIÈRE

Grande taille. Tête caoutchouc dur 90 shores, légèrement bombée. Manche en frêne FSC.



g	B mm	C mm	A mm	L mm	Ref.	☐
1 kg	85	80	130	800	0190000201	1

## MAILLET TP

Spécial Travaux Publics, par exemple pour poser les bordures de trottoir. Tête caoutchouc dur 90 shores, légèrement bombée. Manche en frêne FSC.



g	L mm	B mm	C mm	A mm	Ref.	☐
4 kg	500	120	110	190	0190200201	1
4 kg	1150	120	110	190	0190100201	1







## MARTEAU D'ÉLECTRICIEN

### UTILISATION

- Doté d'une table plate, d'une tête très allongée et d'une panne très mince, il est utilisé pour clouer dans les endroits étroits et fixer les attaches de conduits ou de fils électriques.



### QUALITÉ DE LA TÊTE

- Acier forgé. Forte teneur en carbone. Bon fibrage et chanfreins anti-éclat.
- Grenailage, meulage et mise en peinture électrostatique époxy.
- Double trempe et contrôle des zones de dureté.

### MARTEAU D'ÉLECTRICIEN MANCHE CARBON



Manche quadrimatière.



C mm	A mm	B mm	g	L mm	Ref.	☐
16	126	14	160	256	0416160701	5
18	135	15	200	258	0416180701	5

### MARTEAU D'ÉLECTRICIEN MANCHE LE ROUGE



Manche trimatière.



C mm	A mm	B mm	g	L mm	Ref.	☐
18	135	15	200	258	0416180A01	5

### MARTEAU D'ÉLECTRICIEN MANCHE HICKORY



C mm	A mm	B mm	g	L mm	Ref.	☐	Coin	☐
16	126	14	160	250	0416160301	6640	08	5
18	135	15	200	260	0416180301	6602	09	5
20	142	16	250	260	0416200301	6602	09	2

### MARTEAU D'ÉLECTRICIEN MANCHE FRÈNE



C mm	A mm	B mm	g	L mm	Ref.	☐	Coin	☐
16	126	14	160	250	0416160201	6800	08	5
18	135	15	200	260	0416180201	6801	09	5
20	142	16	250	260	0416200201	6801	09	2

- 16
- 62
- 96
- 120
- 126
- 156
- 188
- 224
- 248
- 254
- 300
- 316
- 340
- 390
- 462
- 488



# MARTEAUX DE MENUISIER



## MARTEAU DE MENUISIER

### UTILISATION

- Marteau utilisé dans le second oeuvre pour l'assemblage et la pose des éléments de bois brut ou autres matériaux.



### QUALITÉ DE LA TÊTE

- Acier forgé.
- Forte teneur en carbone.
- Bon fibrage et chanfreins anti-éclat.
- Grenailage, meulage et mise en peinture électrostatique époxy.
- Double trempe et contrôle des zones de dureté.

### SÉCURITÉ

- Son emmanchement par insert métallique (contre-cône) et résine époxy assure un maximum de sécurité.



### MARTEAU DE MENUISIER MANCHE CARBON



Manche quadrimatière.



C mm	B mm	A mm	g	L mm	Ref.	☐
16	17	85	100	256	0400160701	5
20	18	91	160	260	0400200701	5
22	19	97	200	284	0400220701	5
24	20	103	250	286	0400240701	5
26	23	108	315	288	0400260701	5
28	25	113	400	290	0400280701	5
30	26	122	500	320	0400300701	5
32	27	132	630	322	0400320701	5
36	30	140	800	326	0400360701	5

### MARTEAU DE MENUISIER MANCHE HICKORY



C mm	B mm	A mm	g	L mm	Ref.	☐	Coin	☐
20	18	91	160	260	0400200301	6602	09	5
22	19	97	200	280	0400220301	6603	11	5
24	20	103	250	280	0400240301	6603	11	5
26	23	108	315	280	0400260301	6603	11	5
28	25	113	400	300	0400280301	6605	14	5
30	26	122	500	300	0400300301	6605	14	2

### MARTEAU DE MENUISIER MANCHE LE ROUGE



Manche trimatière.



C mm	B mm	A mm	g	L mm	Ref.	☐
24	20	103	250	286	0400240A01	5
26	23	108	315	288	0400260A01	5
30	26	122	500	320	0400300A01	5

### MARTEAU DE MENUISIER MANCHE FRÈNE



C mm	B mm	A mm	g	L mm	Ref.	☐	Coin	☐
16	17	85	100	250	0400160201	6800	08	5
20	18	91	160	260	0400200201	6801	09	5
22	19	97	200	280	0400220201	6802	11	5
24	20	103	250	280	0400240201	6802	11	5
26	23	108	315	280	0400260201	6802	11	5
28	25	113	400	300	0400280201	6804	14	5
30	26	122	500	300	0400300201	6804	14	2
32	27	132	630	300	0400320201	6805	15	2
36	30	140	800	315	0400360201	6806	16	2



## MASSETTE

### EMMANCHEMENT DROIT ①

- Emmanchement droit, identique à un marteau.
- Le haut du manche est poussé par une machine hydraulique dans la tête, et un capteur d'effort mesure sur chaque produit la puissance d'emmanchement.
- Une résine scelle l'assemblage.
- Les performances à l'arrachement sont beaucoup plus élevées que les normes.
- Ce type d'emmanchement est fréquent dans l'Industrie.



### EMMANCHEMENT CONIQUE ②

- Le manche est enfilé par l'oeil et est tenu en force. L'avantage est que si la tête se démanche, elle n'est jamais éjectée.
- Autre point pratique : le changement de manche est simple et ne nécessite pas de coin. L'inconvénient est que la tête peut descendre vers la main. Il est parfois nécessaire de laisser tremper la tête dans l'eau pour préserver la tenue.
- Cet emmanchement est plébiscité dans le Bâtiment.

### MASSETTE CARRÉE MANCHE CARBON



À angles vifs pour casser ou tailler les agglos ou quartiers, ou frapper de façon homogène. Emmanchement droit.



g	A mm	B mm	C mm	L mm	Ref.	☐
1000	95	36	42	257	0127100701	1
1250	100	41	45	260	0127120701	1
1500	100	44	50	265	0127150701	1

### MASSETTE CARRÉE MANCHE LE ROUGE



À angles vifs pour casser ou tailler les agglos ou quartiers, ou frapper de façon homogène. Emmanchement droit.



g	A mm	B mm	C mm	L mm	Ref.	☐
1250	100	41	45	260	0127120A01	1

### MASSETTE CARRÉE NERFLEX



Emmanchement droit. Produit en fin de vie.

g	A mm	B mm	C mm	L mm	Ref.	☐
1000	95	36	42	250	0127100401	1
1250	100	41	45	250	0127120401	1
1500	100	44	50	260	0127150401	1

### MASSETTE CARRÉE MANCHE HICKORY



À angles vifs pour casser ou tailler les agglos ou quartiers, ou frapper de façon homogène. Emmanchement droit.

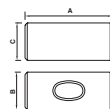

g	A mm	B mm	C mm	L mm	Ref.	☐	Coin	☐
1000	95	36	42	260	0127100301	6650	15	1
1250	100	41	45	260	0127120301	6650	16	1
1500	100	44	50	280	0127150301	6651	17	1

### MASSETTE CARRÉE MANCHE FRÈNE



À angles vifs pour casser ou tailler les agglos ou quartiers, ou frapper de façon homogène. Emmanchement droit.

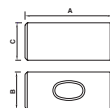

g	A mm	B mm	C mm	L mm	Ref.	☐	Coin	☐
1000	95	36	42	260	0127100201	6870	16	1
1250	100	41	45	260	0127120201	6870	17	1
1500	100	44	50	280	0127150201	6871	17	1



16



62



96



120



126



156



188



224



248



254



300



316



340



390



462



488



273



# MASSETTES

## MASSETTE ANGLES ABATTUS MANCHE FRÊNE



Têtes plates.  
Emmanchement droit.



g	A mm	C mm	L mm	Ref.	✂	Coin	☐
1000	100	40	260	0137100201	6870	16	1
1250	110	43	260	0137120201	6870	17	1
1500	120	45	280	0137150201	6871	17	1

## MASSETTE ANGLES ABATTUS MANCHE NERFLEX

Produit en fin de vie.

g	A mm	C mm	L mm	Ref.	☐
1000	100	40	255	0137100401	1
1250	110	43	258	0137120401	1
1500	120	45	260	0137150401	1

## MASSETTE ANGLES ABATTUS MANCHE CARBON



Têtes plates.  
Emmanchement droit.



g	A mm	C mm	L mm	Ref.	☐
1000	100	40	255	0137100701	1
1250	110	43	258	0137120701	1
1500	120	45	260	0137150701	1

## MASSETTE ESPAGNOLE MANCHE CARBON



Emmanchement droit.

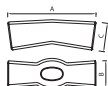

g	A mm	B mm	C mm	L mm	Ref.	☐
1000	125	38	40	250	0129100701	1

## MASSETTE CONIQUE ANGLES ABATTUS MANCHE FRÊNE

Têtes plates. Angles abattus.  
Chanfreins pour diminuer les  
risques d'éclats. Manche frêne.  
Emmanchement conique. PEFC.



g	A mm	C mm	L mm	Ref.	✂	☐
1000	100	40	260	0137110201	6873	1
1250	110	43	260	0137130201	6873	1
1500	120	45	260	0137160201	6873	1

## MASSETTE ANGLES ABATTUS MANCHE NERTECH

Gamme Talabot.  
Angles abattus.  
Chanfreins pour diminuer  
les risques d'éclats.  
Manche tri-matière.  
Emmanchement conique.



g	A mm	C mm	L mm	Ref.	✂	☐
1000	100	40	285	0136110704	6956	1
1250	110	43	285	0136130704	6956	1
1500	120	45	285	0136160704	6956	1



## MASSETTE 4U

### 4 USAGES

- FRAPPER : 2 zones de frappe traditionnelles : pour les ciseaux, broches, burins...
- TRANCHER : un bord vif pour trancher, marquer ou ébrécher des carreaux de plâtre, des parpaings ou du ciment synthétique...
- RÂCLER : un bord denté pour le raclage des surfaces granuleuses (pierre, béton, mortier) et pour gratter les coulures de ciment débordant des joints ou pour faire sauter les grattons.
- POINTER : pour enfoncer les pointes de coffrage dans des espaces restreints.

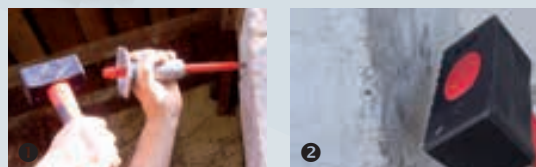

### QUALITÉ

Zone de frappe : dureté 50-58 HRC.  
Chanfreins sur les zones de frappe  
pour éviter les risques d'éclat.  
Manche Nertech tri-matière armé fibre de verre.

## MASSETTE 4U MANCHE NERTECH



Massette 4Usages :  
frapper, pointer, râcler,  
trancher.  
Manche Nertech tri-matière  
armé de fibre de verre.



g	L mm	A mm	B mm	C mm	✂	Ref.	☐
1250	285	102	49	48	6956	0133130701	1



## MANCHE TRI-MATIÈRE NERTECH

### UTILISATION

Pour une frappe puissante ou pour la démolition : long manche pour un bel effet de levier.

### FIBRE DE VERRE

Le manche tri-matière Nertech est armé en fibre de verre, 40 fois plus résistant qu'un manche bois, insensible à l'humidité, aux produits chimiques, aux U.V. et il est non conducteur d'électricité. Il est recommandé dans les cas d'utilisation les plus sévères.

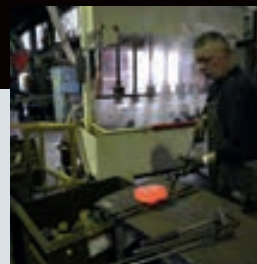

### ATTÉNUATION DES VIBRATIONS

- Polypropylène armé de fibre de verre.

### CONFORT

- Elastomère avec reliefs anti-transpiration.

### MASSE COUPLE MANCHE FRÊNE

Angles abattus par chanfreinage pour diminuer les risques d'éclats. Manche léger et facile à changer. En frêne PEFC. Emmanchement conique.



kg	A mm	C mm	L mm	Ref.	🔩	📦
3000	155	55	900	0136310201	6884	1
4000	170	62	900	0136410201	6884	1
5000	175	67	900	0136510201	6884	1

### MASSE COUPLE MANCHE HICKORY

Têtes bombées, angles abattus. Emmanchement droit avec coin. Manche Hickory américain très résistant.



kg	A mm	C mm	L mm	Ref.	🔩	Coin	📦
2000	130	50	270	0136200301	6652	18	1
3000	155	55	700	0136300301	6667	18	1
4000	170	62	800	0136400301	6668	18	1
5000	175	67	900	0136500301	6669	16	1
6000	180	71	900	0136600301	6669	16	1
8000	190	80	1000	0136800301	6670	18	1

### MASSE COUPLE MANCHE TRI-MATIÈRE

Angles abattus. Manche Nertech tri-matière. Emmanchement conique.

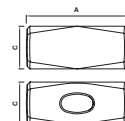

kg	A mm	C mm	L mm	Sans manche		Nertech		
				Ref.	📦	Ref.	🔩	📦
3	155	55	900	0136310101	1	0136310701	6954	1
4	170	62	900	0136410101	1	0136410701	6954	1
5	175	67	900	0136510101	1	0136510701	6954	1

### MASSE À TRANCHE MANCHE BOIS

Tranche à froid. Manche frêne PEFC.



kg	A mm	C mm	L mm	Ref.	🔩	📦
4000	190	60	900	0135410201	6884	1

### MASSE À TRANCHE MANCHE NERTECH

Tranche à froid. Manche Nertech tri-matière armé de fibre de verre.



kg	A mm	C mm	L mm	Ref.	🔩	📦
4000	190	60	900	0135410701	6954	1





# MARTEAUX DE COFFREUR



## MARTEAU DE COFFREUR TÊTE RACLANTE

Zone de maintien du clou. Zone de frappe dureté 52-58 HRC.

### ➤ GALBE ÉTUDIÉ

Grip anti-transpirant et antidérapant = Bonne prise en main.



### ➤ ZONE CONVEXE DE PRÉHENSION

= Plus large pour frapper.

### ➤ ZONE CONCAVE POUR RACLER

= La main ne glisse pas.

### ➤ LONG MANCHE POUR :

= Faciliter l'accès à des zones éloignées.  
= Augmenter l'effet levier.

### ➤ TROU D'ACCROCHE



Raclage de surfaces irrégulières en zone éloignée



Raclage de surfaces lisses



Arrache-clou effilé



Effet de levier plus puissant grâce au manche long



Idéal pour coffrage

### MARTEAU DE COFFREUR RACLEUR MANCHE NERTECH



Tête raclante. Manche trimatière armé de fibre de verre.



L mm	A mm	B mm	C mm	D mm	g	Ref.	🔩	📦
375	180	41	28	38	845	0478000701	6959	1

### MARTEAU DE COFFREUR MANCHE NERTECH



Manche trimatière armé de fibre de verre.



L mm	A mm	B mm	C mm	D mm	g	Ref.	🔩	📦
375	175	30	32	40	750	0476000701	6959	1

### MARTEAU DE COFFREUR RACLEUR TÊTE AIMANTÉE MANCHE NERTECH



Avec aimant pour pointer d'une main sans tenir le clou. Tête raclante.



L mm	A mm	B mm	C mm	D mm	g	Ref.	🔩	📦
375	180	41	28	38	845	0478011701	6959	1

### MARTEAU DE COFFREUR MANCHE TRI-MATIÈRE

Gamme Talabot. Tête avec aimant.



L mm	A mm	B mm	C mm	D mm	g	Ref.	🔩	📦
375	175	30	34	40	830	0476000704	6959	1



## MARTEAU DE COFFREUR MANCHE FRÈNE

Haute qualité. Panne droite.  
Manche frêne PEFC.



L mm	A mm	B mm	C mm	D mm	g	Ref.		
375	175	30	32	40	750	0476000201	6853	2

## MARTEAU DE COFFREUR TÊTE AIMANTÉE MANCHE FRÈNE

Avec aimant pour pointer  
d'une main sans tenir le clou.  
Manche frêne PEFC.



L mm	A mm	B mm	C mm	D mm	g	Ref.		
375	175	30	32	40	825	0476011201	6853	1

## MARTEAU BOURGEOIS

Modèle français.



A mm	B mm	C mm	L mm	g	Ref.	
28	22	110	320	315	0403280201	2
32	26	120	340	500	0403320201	2

## MARTEAU DE LYON

Charpentier et maçon  
modèle « Lyon ».



C mm	B mm	A mm	D mm	L mm	g	Ref.		
32	28	145	44	375	700	0405000201	6853	2



## MARTEAU U.S. X STRIKER

### ARRACHE-CLOU MODÈLE AMÉRICAIN « UNE PIÈCE »



- Ligne racée et légère.
- Tête et manche forgés en une pièce.
- Corps aminci pour un poids contrôlé.
- Traitement thermique localisé et chanfrein tournant anti-éclat.

### POIGNÉE EN CAOUTCHOUC SYNTHÉTIQUE AMORTISSANT

- Perforations et forme légèrement galbée anti-glisse.

### PUISSANCE

- Clouer d'un geste sûr et puissant est facile avec la frappe sèche et le poids d'un marteau une pièce.
- Panne courbe pour déclouer avec un bon effet de levier.



## MARTEAU U.S. X STRIKER

Forgé 1 pièce. Entièrement poli. Panne arrache-clou.  
Poignée élastomère bicolore absorbant chocs et vibrations.



B mm	D mm	A mm	L mm	g	Ref.	
30	25	25	295	880	0409000001	1

## MARTEAU D'EMBALLEUR U.S. MAGNET

Modèle américain.  
Tête en acier trempé pour clouer.  
Pastille aimant. Panne arrache-clou.  
Manche acier tubulaire chromé.  
Poignée élastomère.



B mm	D mm	A mm	L mm	g	Ref.	
30	25	105	295	455	0409010501	1

## MARTEAU D'EMBALLEUR U.S.

Modèle américain.  
Tête en acier trempé pour clouer.  
Panne arrache-clou.  
Manche acier tubulaire chromé.  
Poignée élastomère.



B mm	D mm	A mm	L mm	g	Ref.	
26	25	100	295	450	0409210501	2
30	34	130	325	710	0409290501	2



16



62



96



120



126



156



188



224



248



254



300



316



340



390



462



488



277



# MARTEAUX DE CHARPENTIER



## MARTEAU DE CHARPENTIER X STRIKER

### CARACTÉRISTIQUES

- Forgé une pièce « One Piece », incassable.
- Tête quadrillée.
- Logement de clou double, avec aimant.
- Panne à pointe unique pour planter l'outil dans la charpente et avoir les mains libres.
- Traitement thermique localisé sur la zone de frappe et 4 chanfreins anti-éclat.

### 3 MANCHES AU CHOIX

- Poignée haut de gamme cuir.
- Poignée élastomère.
- Manche tubulaire avec poignée élastomère pour les charpentiers qui ne sont pas One Piece.

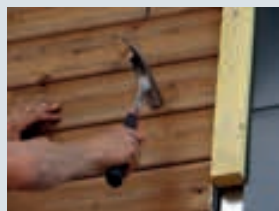
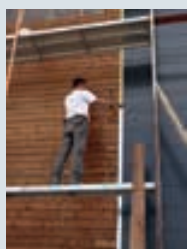

Certifiés selon les exigences du GS  
(Geprüfte Sicherheit signifie sécurité testée)

### MARTEAU DE CHARPENTIER X STRIKER ONE PIECE

Forgé 1 pièce. Entièrement poli.  
Poignée élastomère. Tête profilée. Pastille aimant



L mm	B mm	A mm	g	Ref.	☐
320	27	175	950	040700001	1

### MARTEAU DE CHARPENTIER X STRIKER ONE PIECE MANCHE CUIR

Forgé 1 pièce. Entièrement poli. Tête profilée. Pastille aimant. Poignée cuir pour une souplesse inégalée.



L mm	B mm	A mm	g	Ref.	☐
320	27	175	960	5130070000	1

### MARTEAU DE CHARPENTIER X STRIKER TÊTE POLIE MANCHE TUBE

Tête profilée du X Striker. Manche acier tubulaire, poignée élastomère. Tête entièrement polie. Pastille aimant. Quadrillage poli.



L mm	B mm	A mm	g	Ref.	☐
320	27	170	825	5123250000	1

### MARTEAU DE CHARPENTIER MANCHE TUBE

Tête profilée du X Striker. Manche acier tubulaire, poignée élastomère. Dessus de la tête poli, côtés polis puis peints noir. Quadrillage poli et noir.



B mm	A mm	L mm	g	Ref.	☐
27	170	320	800	0407010501	1

### MARTEAU DE CHARPENTIER STANDARD

Modèle "Est". Manche acier tubulaire. Poignée élastomère. Pastille aimant



B mm	A mm	L mm	g	Ref.	☐
27	170	320	800	0407000501	2





## MARTELLERIE NERTECH BÂTIMENT

### UTILISATION

- Pic : pointe pour enlever les crépis, nettoyer les joints et gratter entre les pierres
- Panne : taillant pour racler les anciens enduits (façadier) ou amorcer une cassure sur les briques (maçon). Lorsque la panne est verticale, elle sert de hachette ou simplement à ajuster la position de travail.
- Tête : surface de frappe pour casser briques, parpaings et parements.



### TRI-MATIÈRE

1. Fibre de verre = souple, léger et incassable.
2. Polypropylène = anti-vibration.
3. Élastomère = antiglisse et anti-ampoule.

### QUALITÉ DE LA TÊTE

- Acier à forte teneur en carbone, forgé et trempé pour un taillant optimal et une excellente résistance à la frappe.
- Tête polie, puis peinte avec une peinture texturée noire.



Tête et pic



Pic et panne



Panne verticale et tête



Double panne



Panne horizontale et tête

### MARTELETTE TÊTE ET PIC MANCHE NERTECH

1 tête et 1 pic.  
Manche Nertech tri-matière.



▲ g	A mm	B mm	C mm	L mm	Ref.	🔩	📦
700	250	24	26	375	0181000701	6959	1

### DÉCINTROIR À PIC MANCHE NERTECH

1 pic et 1 panne horizontale.  
Appelée aussi martelette pic et panne.  
Manche Nertech tri-matière.



L mm	A mm	B mm	▲ g	Ref.	🔩	📦
375	330	40	750	0186000701	6959	1

### DÉCINTROIR À HACHE MANCHE NERTECH

1 panne horizontale et 1 panne verticale.  
Manche Nertech tri-matière.



▲ g	A mm	B mm	L mm	Ref.	🔩	📦
750	320	34	375	0123070701	6959	1

### HACHETTE DE MAÇON MANCHE NERTECH

1 panne verticale et 1 tête.  
Manche Nertech tri-matière.



▲ g	A mm	B mm	C mm	D mm	L mm	Ref.	🔩	📦
865	250	23	26	34	375	0121070701	6959	1

### MARTEAU À BRIQUES MANCHE NERTECH

1 panne horizontale et 1 tête.  
Manche Nertech tri-matière.



▲ g	A mm	B mm	C mm	L mm	Ref.	🔩	📦
750	260	23	26	375	0118070701	6959	1



16



62



96



120



126



156



188



224



248



254



300



316



340



390



462



488



# MARTEAUX DE MAÇON

## MARTELETTE TÊTE ET PIC MANCHE FRÈNE

1 pic et 1 tête.  
Manche frêne PEFC.



▲ g	A mm	B mm	C mm	L mm	Ref.		
700	250	24	26	375	0181000201	6853	1

## DÉCINTROIR À PIC MANCHE FRÈNE

Martelette pic et panne.  
Manche frêne PEFC.



▲ g	A mm	B mm	L mm	Ref.		
750	330	40	375	0186000201	6853	1

## HACHETTE DE MAÇON MANCHE FRÈNE

1 panne verticale et 1 tête.  
Manche frêne PEFC.



▲ g	A mm	B mm	C mm	D mm	L mm	Ref.		
865	250	23	26	34	375	0121070201	6853	1

## DÉCINTROIR À HACHE MANCHE FRÈNE

1 panne horizontale  
et 1 panne verticale.  
Manche frêne PEFC.



▲ g	A mm	B mm	L mm	Ref.		
750	320	34	375	0123070201	6853	1

## MARTEAU À BRIQUES MANCHE FRÈNE

1 panne horizontale et 1 tête.  
Manche frêne PEFC.



▲ g	A mm	B mm	C mm	L mm	Ref.		
750	260	23	26	375	0118070201	6853	1

## MARTELETTE MARSEILLAISE MANCHE FRÈNE

1 panne verticale large et 1 tête.  
Manche frêne PEFC.



▲ g	A mm	B mm	C mm	D mm	L mm	Ref.		
600	215	23	25	60	375	0159060201	6853	1

## PIC À DÉGRADER MANCHE FRÈNE

2 pointes.  
Manche frêne PEFC.



▲ g	A mm	C mm	L mm	Ref.		
1000	320	30	350	0169000201	6852	1

## MARTEAU DE MAÇON MANCHE FRÈNE

Tête et pointe.  
Manche frêne PEFC.



▲ g	A mm	C mm	L mm	Ref.		
1500	195	40	375	0105150201	6853	1

## TÊTU DE MAÇON MANCHE FRÈNE

1 tête creuse et 1 pointe.  
Manche frêne PEFC.



▲ g	A mm	B mm	C mm	R mm	L mm	Ref.		
1250	205	26	35	35	350	0103120201	6852	1

## TÊTU DE MAÇON MANCHE FRÈNE

1 tête creuse et 1 panne horizontale,  
dite aussi « taillant en long »  
Manche frêne PEFC.



▲ g	A mm	B mm	C mm	D mm	R mm	L mm	Ref.		
1000	190	30	26	40	35	350	0104100201	6852	1

## BOUCHARDE MANCHE FRÈNE

De 25 et 49 dents.  
Manche frêne PEFC.



▲ g	A mm	C mm	L mm	Ref.		Coin	
2000	175	40	380	0115200301	6610	18	1

## BOUCHARDE À PLAQUETTES MANCHE FRÈNE

De 25 et 49 dents.  
Manche frêne PEFC.



▲ g	A mm	B mm	C mm	∅ mm	E mm	L mm	Ref.		Coin	
2000	200	18	40	20	5	380	0162000301	6610	18	1

## PLAQUETTE POUR BOUCHARDE

De 25 à 100 dents.



DT*	▲ g	Ref.	
25	125	0164250610	1
36	125	0164360610	1
49	125	0164490610	1
81	125	0164810610	1



## HACHETTE DE PLÂTRIER

### UTILISATION

- Tranche lors de travaux de démolition (panneaux, câbles..)
- ou travail en carreaux de plâtre
- 1 côté frappe (clous..).
- 1 côté taillant.
- Arrache clou intégré côté taillant.

### CHOIX DE MANCHE

- Nertech : tri-matière armé de fibre de verre, surmoulé polypropylène et élastomère.
- Tubulaire : bon rapport qualité/prix.
- Bois : léger et facile à changer.



### HACHETTE DE PLÂTRIER MANCHE NERTECH

Manche tri-matière.



L mm	A mm	B mm	C mm	E mm	g	Ref.		
375	220	24	27	45	600	0436000701	6959	1

### HACHETTE DE PLÂTRIER MANCHE FRÊNE

Manche bois léger et facile à changer. Frêne PEFC.



L mm	A mm	B mm	C mm	E mm	g	Ref.		
350	220	24	27	45	600	0436000201	6852	1

### HACHETTE DE PLÂTRIER MANCHE ACIER

Manche acier tubulaire poignée caoutchouc.

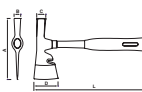

L mm	A mm	B mm	C mm	D mm	g	Ref.		
320	175	24	27	70	800	0436000501		1

### HACHETTE DE COFFREUR MANCHE FRÊNE

Pour tailler les pièces de bois de coffrage.  
Manche frêne PEFC.



L mm	A mm	B mm	C mm	D mm	E mm	g	Ref.		
375	205	23	26	115	60	750	0502010201	6853	1

### HACHETTE MANCHE FRÊNE

À douille.



L mm	A mm	D mm	g	Ref.		
350	180	105	750	0500000201	6852	1

### HACHETTE CANADIENNE MANCHE FRÊNE

Manche frêne PEFC.



L mm	A mm	D mm	g	Ref.		
360	155	105	600	0505000201	6950	1



16



62



96



120



126



156



188



224



248



254



300



316



340



390



462



488



# HACHETTES ET HÂCHES

## HACHE FRANÇAISE MANCHE FRÊNE

Manche frêne PEFC.



L mm	A mm	D mm	g	Ref.		
900	250	150	1500	0504000201	6884	1

## HACHETTE DE POMPIER

Manche tubulaire acier.



L mm	A mm	B mm	g	Ref.	
330	80	200	1035	0503000501	1

## MERLIN MANCHE NERTECH



g	A mm	B mm	C mm	D mm	L mm	Ref.		
2500	200	46	52	88	900	0445250701	6954	1
3000	210	48	54	95	900	0445300701	6954	1

## MERLIN MANCHE FRÊNE

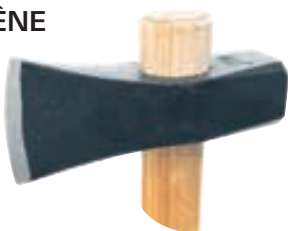

g	A mm	B mm	C mm	D mm	L mm	Ref.		
2500	200	46	52	88	900	0445250201	6884	1
3000	210	48	54	95	900	0445300201	6884	1

## COIN À BOIS ÉCLATEUR

Fend en 4 bûchettes.



g	Ref.	
1750	5194010000	1

## COIN À BOIS

Évidé.



g	D mm	A mm	Ref.	
1250	35	190	0448100601	1
1500	40	220	0448150601	1
1750	45	250	0448200601	1
2250	48	260	0448250601	1

## AUTRES MARTEAUX DE MÉTIER

### MARTEAU DE BIJOUTIER



A mm	B mm	D mm	L mm	g	Ref.		
89	13	16	350	100	0442000301	6660	1

### MARTEAU DE VITRIER

Manche acier. Tête plate pour planter des pointes et maintenir le verre.  
Panne fendue pour arracher les clous.  
Utilisé pour travailler le verre, équipé d'un biseau pour démastiquer - modèle « Paris ».



A mm	A1 mm	B mm	D mm	C mm	D1 mm	g	Ref.	
105	260	17	17	17	25	400	0179000510	1

### MARTEAU DE TAPISSIER

Panne aimantée.  
Manche frêne PEFC.

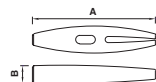

S mm	A mm	L mm	g	Ref.		
14	100	250	200	0447000201	6800	1

### MARTEAU DE MINÉRALOGISTE

Manche acier tubulaire  
poignée caoutchouc

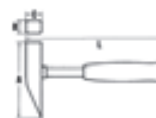

B mm	C mm	A mm	L mm	g	Ref.		
27	38	145	320	950	0435000501	6800	1

### MARTEAU À PLANER LES SCIES



A mm	B mm	C mm	L mm	g	Ref.		Coin	
130	20	40	315	1000	0263100301	6607	16	1



## CHANGER SON MANCHE

### RÉEMMANCHER AVEC UN MANCHE BOIS « DROIT »

- Prendre le manche de rechange correspondant
- Choisir un coin qui entre dans l'oeil mais n'en ressort pas.
- Râper si nécessaire pour que le manche entre au minimum à ras dans l'œil (il est normal qu'il y ait un ajustement à faire car MOB a fait légèrement évoluer ses yeux et manches au cours du temps).
- Si le manche dépasse de l'œil, retaillez avant de mettre les coins.
- Mettre le coin, avec un marteau, jusqu'à ce que le manche ait une bonne tenue dans l'œil. Pour une masse, placer 2 coins métalliques l'un à côté de l'autre. Les coins ne doivent pas dépasser du manche.



Nota : l'emmanchement réalisé par des utilisateurs n'est plus garanti par MOB.



## COINS CYLINDRIQUES

En sachet.



Ø mm	Adapté à	Nb de pièces	L mm	Ref.	📦	👤 g
08	Riv. 18 - garnir 18 - élec. 16 - men. 16	x 10	11,3	6978081001	1	20
09	Garnir 22 - élec 18 et 20 - men. 20	x 10	13	6978091001	1	27
10	Riv. 22	x 10	15	6978101001	1	35
11	Riv. 24, 26 et 28 - garnir 26 et 28 - men. 22, 24 et 26 - p. soud. 0,3kg	x 10	17,3	6978111001	1	40
12	Riv. 30 - p. soud. 0,4kg	x 10	18,8	6978121001	1	60
13	Garnir 32 et 36	x 10	19	6978131001	1	75
14	Riv. 32 - men. 28 et 30 - p. soud. 0,5kg	x 10	20,3	6978141001	1	90
15	Riv. 36 - men. 32 - garnir 40 - p. soud. 0,6kg	x 10	21,8	6978151001	1	110
16	Riv. 40 - men. 36	x 10	24	6978161001	1	140
17	Riv. 42 et 45	x 10	25	6978171001	1	160
18	Riv. 50 et plus	x 10	25	6978181001	1	200

## COMPOSITION DE 2 COINS



Ø mm	Adapté à	Ref.	📦
10 - 12	Rivoir 22 à 30 - men. 22 à 26 mm	6972001001	5
14 - 16	Rivoir 32 à 40 - men. 28 à 36 mm	6973001001	5

## COMPOSITION DE 5 COINS



Ø mm	Adapté à	Ref.	📦
11- 12- 14- 16- 18	11 : Riv. 24 et 26 - garnir 26 et 28 - men. 22, 24 et 26 - p. soud. 0,3kg 12 : Riv. 28 et 30 - p. soud. 0,4kg 14 : Riv. 32 - men. 28 et 30 - p. soud. 0,5kg 16 : Riv. 40 - men. 36 - massette 18 : Riv. 50 et plus	6971001001	5



## MANCHES VENDUS EN RECHANGE

### HICKORY

Bois très dur haute résistance, l'hickory est l'essence la mieux adaptée aux usages intensifs. Il convient parfaitement à un usage professionnel.



### FRÈNE

Bois dur et souple, adapté aux frappes modérées.



### NERTECH

Long manche tri-matière incassable et indémanchable pour œil conique.

- Fibre de verre : résistance, flexibilité, force.
- Polypropylène : ergonomie, antivibration.
- Elastomère : confort tactile, nervure d'aération de la main, surface structurée antidérapante.



## MANCHE NERTECH POUR MARTEAUX TÊTUS DE MAÇON RUSTIQUES ET COFFREURS

Emmanchement conique.



L mm	A mm	B mm	👤 g	Ref.	📦
375	39	29	155	6959000701	1

## MANCHES FRENE POUR MARTEAUX TÊTUS DE MAÇON RUSTIQUES ET COFFREURS

Emmanchement conique.



L mm	A mm	B mm	👤 g	Ref.	📦
350	38	28	135	6852000201	5
375	39	29	155	6853000201	5
400	41	31	180	6854000201	5

## MANCHES DE MASSETTE FRÈNE

Emmanchement droit : ajouter un coin.



L mm	A mm	B mm	👤 g	Ref.	📦
250	31	18	100	6870000201	5
260	32,5	19	130	6871000201	5
270	36,5	21	160	6872000201	5

## MANCHES DE MASSETTE HICKORY

Emmanchement droit : ajouter un coin.



L mm	A mm	B mm	👤 g	Ref.	📦
250	31	18	100	6650000301	5
260	32,5	19	130	6651000301	5
270	36,5	21	160	6652000301	5



16



62



96



120



126



156



188



224



248



254



300



316



340



390



462



488



# HACHETTES ET HÂCHES

## MANCHES DE MASSETTE NERTECH

Emmanchement conique - sans coin.



L mm	A mm	B mm	g	Ref.	
285	40	28,5	140	6956000701	1

## MANCHES DE MASSETTE FRÊNE

Emmanchement conique - sans coin.



L mm	A mm	B mm	g	Ref.	
285	40	28,5	140	6873000201	1

## MANCHES DE MASSETTE HICKORY

Emmanchement conique - sans coin.



L mm	A mm	B mm	g	Ref.	
285	40	28,5	140	6653000301	1

## MANCHES HICKORY POUR MARTEAUX DE BIJOUTIER ET DE CARRELEUR



L mm	A mm	B mm	g	Ref.	
340	13	8	120	6660000301	5

## MANCHES HICKORY POUR MASSES ET MERLINS

Emmanchement droit : ajouter un coin.



L mm	A mm	B mm	g	Ref.	
1000	50,5	28,5	870	6670000301	1
700	38,2	20,6	560	6667000301	1
800	38,2	20,6	700	6668000301	1
900	44	23	860	6669000301	1

## MANCHES NERTECH POUR MARTEAU À MAIN - MASSES - MERLINS

Emmanchement conique (sans coin).



L mm	A mm	B mm	g	Ref.	
900	50,5	34,5	800	6954000701	1

## MANCHES FRÊNE DE HACHETTE CANADIENNE

Vendu avec un coin rond et un coin droit.



Pour ref.	L mm	A mm	B mm	g	Ref.	
0505000201	360	43	18	200	6950000001	1

## MANCHES HICKORY DE MAILLET EN BOIS LAMELLE FRETTE DYNACHOC



L mm	A mm	B mm	g	Ref.	
260	23	23	65	6821000301	1
300	16	16	90	6821060301	1
300	27	27	95	6821010301	1
320	30	30	150	6821020301	1
360	33	33	175	6821030301	1
390	32	32	195	6821040301	1
420	36	36	295	6821050301	1

## MANCHES FRÊNE DE MAILLET CAOUTCHOUC



Pour ref.	L mm	A mm	B mm	g	Ref.	
0190000201	800	38	31	310	6820050201	1
0190100201	1150	47	37	550	6822000201	1
0348055201 & 0367500201	300	31	26	90	6820020201	1
0348065201 & 0367600201	330	33	28	105	6820030201	1
0348075201 & 0367700201 & 0367900201	380	37	31	155	6820040201	1
0367400201	280	24	18	45	6820010201	1

## MANCHE HICKORY POUR RIVOIRS - GARNIR - ÉLECTRICIENS - MENUISIER



Pour ref.	Coin	L mm	Ref.	
0001360201 & 0400320201	15	315	6606000301	5
0001400201 & 0400360201	16	330	6607000301	5
0001420201	17	350	6608000301	5
0002450201 & 0002500201	17	380	6609000301	5
0002550201	18	380	6610000301	5
0204300301 & 0469350301 & 0213300301 & 0208300301 & 0200300301 & 0298000301 & 0209300301 & 0001300301 & 0430400301	12	280	6604000301	5
0400220201 & 0400240201 & 0400260201	11	260	6603000301	5
0400280201 & 0400300201	14	300	6605000301	5
0416160201	8	250	6640000301	5
0416180201 & 0416200201 & 0400200201	9	250	6602000301	5

## MANCHES FRÊNE POUR RIVOIRS - GARNIR - ÉLECTRICIENS - MENUISIER



Pour ref.	Coin	L mm	g	Ref.	
0001300201 & 0430400201	12	280	66	6803000201	5
0001360201 & 0400320201	15	315	120	6805000201	5
0001400201 & 0400360201	16	330	135	6806000201	5
0001420201	17	350	160	6807000201	5
0002450201 & 0002500201	17	380	210	6808000201	5
0002550201	18	380	235	6809000201	5
0400220201 & 0400240201 & 0400260201	11	260	65	6802000201	5
0400280201 & 0400300201	14	300	105	6804000201	5
0416160201	8	250	50	6800000201	5
0416180201 & 0416200201 & 0400200201	9	250	55	6801000201	5

## MANCHE HICKORY PROTECT



Pour ref.	Coin	L mm	Ref.	
0001329301	11	320	6675050301	1
0001369301	12	330	6675060301	1
0001409301	12	330	6675080301	1
0200289301	08	300	6675030301	1

## MANCHES FRÊNE POUR MARTEAU À MAIN - MASSES - MERLINS

Emmanchement conique (sans coin).



L mm	A mm	B mm	g	Ref.	
900	50,5	34,5	800	6884000201	1



## DE L'INDUSTRIE AUX MÉTIERS DU BÂTIMENT, UNE GAMME COMPLÈTE D'OUTILS FORGÉS

MOB vous propose une gamme riche d'outils tranchants couvrant l'ensemble de vos besoins.



### 2 QUALITÉS D'ACIER SONT PROPOSÉES :

- Affûtable : acier à haute teneur en carbone C55 pour une très bonne longévité.
- Réaffûtable à cœur : un acier allié au manganèse silicium (qualité S), qui assure un très bon rendement en plus d'une résistance maximale de l'outils.



### TAILLANT AGRESSIF

La forge et le traitement thermique du tranchant confèrent un taillant agressif et résistant.

### TÊTE DE SÉCURITÉ FORGÉE

- Protège partiellement la main
- Évite le champignonnage sous les coups répétés.

Tête de sécurité breveté

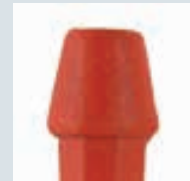

## POIGNÉE PARE-COUPS

### POLYVALENCE

Poignée pare-coups à lamelles intérieures adaptable sur section ronde, hexagonale, octogonale et plate.

### ERGONOMIE

Galbe pensé pour une bonne prise en main.

### PRATIQUE

Modèle spécial développé par MOB, avec évasement octogonal : posé l'outil ne roule pas.



### POIGNÉE PARE-COUPS

Ailettes anti-vibration.  
Forme hexagonale.



### RONDELLE PARE-COUPS

Forme hexagonale.



N°	Utilisation	g	Ref.	☐
1	Broches et ciseaux	90	7311000001	1
2	Broches évidées	90	7312000001	1
3	Ciseaux à brique	83	7313000001	1

g	Ref.	☐
55	7303000001	5



16



62



96



120



126



156



188



224



248



254



300



316



340



390



462



488



285



# BURINS ET BÉDANES



## BURIN DE MÉCANICIEN

### QUALITÉ

- Pour assurer une résistance maximale de l'outil nous choisissons nos aciers et proposons 2 gammes : C55 à haute teneur en carbone ou qualité «S» au manganèse silicium.
- Le burin est forgé et trempé. Le traitement thermique du tranchant lui confère un taillant agressif et une longévité supérieure dans le temps.

### TÊTE DE SÉCURITÉ

- Ce procédé breveté évite le champignonage, les éclats et protège la main partiellement.

### FABRICATION

- Nos outils sont réalisés dans nos usines, sur le site de IUS, en Europe.



### BURIN DE MÉCANICIEN - ACIER ALLIÉ

Qualité "S".  
Acier au manganèse  
silicium - réaffûtable.

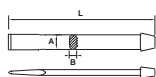

L mm	A mm	B mm	g	Ref.	Poignée adaptée	☐
160	16	8	150	7210160001		5
180	18	9	210	7210180001		5
200	20	10	280	7210200001		5
220	22	11	370	7210220001		5
250	25	12	500	7210250001	7313	5
300	26	13	680	7210300001	7313	5
350	26	13	810	7210350001	7313	5
400	26	13	920	7210400001	7313	5
500	26	13	1140	7210500001		5

### BURIN DE MÉCANICIEN, ACIER ALLIÉ, AVEC POIGNÉE

Qualité "S".  
Acier au manganèse  
silicium - réaffûtable.

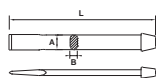

L mm	A mm	B mm	g	Ref.	☐
250	25	12	500	7210250201	1
300	26	13	680	7210300201	1

### BURIN DE MÉCANICIEN

Acier - affûtable.

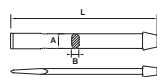

L mm	A mm	B mm	g	Ref.	Poignée adaptée	☐
160	16	8	150	7240160001		5
180	18	9	210	7240180001		5
200	20	10	280	7240200001	7311	5
220	22	11	380	7240220001		5
250	25	12	530	7240250001	7313	5
300	26	13	740	7240300001	7313	5
350	26	13	840	7240350001	7313	5
400	26	13	950	7240400001	7313	5
500	26	13	1240	7240500001	7313	5

### BURIN DE MÉCANICIEN AVEC POIGNÉE

Acier - affûtable.

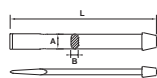

L mm	A mm	B mm	g	Ref.	☐
200	20	10	280	7240200201	1
250	25	12	530	7240250201	1
300	26	13	740	7240300201	1
500	26	13	1240	7240500201	1





## BURIN EXTRA PLAT - CISEAU DE CARROSSIER



Qualité "S".  
Acier au manganèse  
silicium - réaffûtable.

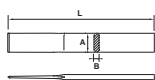

L mm	A mm	B mm	g	Ref.	☐
240	26	7	230	721200001	5

## BÉDANE DE MÉCANICIEN - ACIER ALLIÉ



Qualité "S".  
Acier au manganèse silicium -  
réaffûtable.

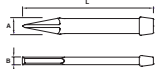

L mm	A mm	B mm	g	Ref.	☐
160	16	8	140	7211160001	5
180	18	9	190	7211180001	5
200	20	10	260	7211200001	5
220	22	11	340	7211220001	5
250	25	12	480	7211250001	5

## BÉDANE DE MÉCANICIEN



Acier - affûtable.

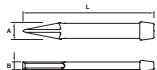

L mm	A mm	B mm	g	Ref.	Poignée adaptée	☐
180	18	9	190	7241180001		5
200	20	10	260	7241200001	7311	5
220	22	11	340	7241220001	7311	5
250	25	12	480	7241250001	7313	5

## BÉDANE DE MÉCANICIEN AVEC POIGNÉE



Acier - affûtable.

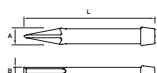

L mm	A mm	B mm	g	Ref.	☐
250	25	12	480	7241250201	5

## BURIN LATÉRAL

Coupe latérale et en bout.  
Également utilisé pour  
démastiquer.

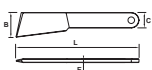

L mm	B mm	C mm	E mm	g	Ref.	☐
200	38	25	6	200	0466000601	1

## POINTEAU DE MÉCANICIEN

Corps moleté.  
Acier chrome vanadium.



Ø mm	S mm	L mm	g	Ref.	☐
2,5	7	100	20	7253020010	10
3	7	100	20	7253030010	10
4	8	100	30	7253040010	10
6	10	115	60	7253060010	10
8	12	130	100	7253080010	10

## POINTEAU DE MÉCANICIEN

Corps hexagonal.  
Acier chrome vanadium.



Ø mm	S mm	L mm	g	Ref.	☐
4	10	120	40	7254100010	10
6	12	120	70	7254120010	10
8	12	150	125	7254150010	10

## POINTEAU AUTOMATIQUE

Pointe acier.



L mm	Section Ø mm	Ref.	☐
130	16	7250000010	1

## CHASSE-POINTS

Corps moleté.  
Acier chrome vanadium.



Ø mm	S mm	L mm	g	Ref.	☐
2	7	100	20	7251020010	10
3	7	100	20	7251030010	10
4	8	100	30	7251040010	10
5	8	100	30	7251050010	10
8	10	115	60	7251080010	10
10	12	130	106	7251100010	10

## CHASSE-POINTS

Corps hexagonal.  
Acier chrome vanadium.



Ø mm	S mm	L mm	g	Ref.	☐
2	10	120	70	7252020010	10
3	10	120	70	7252030010	10
4	10	120	70	7252040010	10
5	10	120	70	7252050010	10

## TIRE-GOUPILLES

Acier.



Ø mm	S mm	L mm	g	Ref.	☐
2	18	230	430	7220230001	1
2	18	500	1000	7220500001	1

## GRATTOIR TRIANGULAIRE

Lame forme triangulaire affûtable  
en acier spécial.  
Finition chromé polie.  
Manche bois peint avec virole acier.



L mm	g	Ref.	☐
200	190	7213200010	1

## GRATTOIR COURBE

Lame forme courbe affûtable  
en acier spécial.  
Finition chromé polie.  
Manche bois peint avec virole acier.



L mm	g	Ref.	☐
200	180	7214200010	1



16



62



96



120



126



156



188



224



248



254



300



316



340



390



462



488





# CHASSE-GOUPILLES

## BOUTEROLLE À MAIN

Coupante.

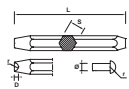

Ø mm	r mm	D mm	S mm	L mm	g	Ref.	☐
10	8,7	5,6	24	175	660	0225100610	1
3	2,5	2	12	125	120	0225030610	1
4	3,5	3	14	135	175	0225040610	1
5	4,5	4	16	145	235	0225050610	1
6	5,5	4	18	155	260	0225060610	1
8	7	4,8	22	165	525	0225080610	1

## BROCHE DE CHAUDRONNIER

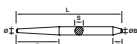

S mm	Ø mm	B mm	E mm	F mm	L mm	g	Ref.	☐
10	4,5	5	63	10	150	70	0302100610	1
12	5	5,5	68	12	170	120	0302120610	1
14	6,5	6	73	15	180	170	0302140610	1
16	8	7	78	17	190	240	0302160610	1
18	9	8	84	19	200	320	0302180610	1
20	10,5	9	90	20	210	400	0302200601	1
22	12	11	97	21	220	520	0302220601	1
24	13	12	103	22	230	630	0302240601	1
26	14,7	13	112	23	240	780	0302260601	1
28	16	15	119	24	250	920	0302280601	1
30	17	17	127	25	260	1100	0302300601	1
32	18	18	137	26	275	1300	0302320601	1

## CHASSE-GOUPILLES DE MÉCANICIEN RONDS

Corps rond moleté.

Acier chrome vanadium.



Ø mm	S mm	L mm	g	Ref.	☐
10	12	130	100	7258100010	10
2	7	100	20	7258020010	10
3	7	100	20	7258030010	10
4	8	100	30	7258040010	10
5	8	100	30	7258050010	10
6	10	115	60	7258060010	10
7	10	115	60	7258070010	10
8	10	115	60	7258080010	10
9	12	130	100	7258090010	10

## STAND DE 6 CHASSE-GOUPILLES

Corps moleté.

Acier chrome vanadium.



6 pcs	Ø mm	g	Ref.	☐
	3-4-5-6-8-10	380	7259000010	1



## CHASSE-GOUPILLES AIR

### 3 PARTIES

- 1 tige chasse-goupilles en acier trempé.
- 1 poignée métallique.
- 1 surmoulage en plastique soft pour la prise en main.



## CHASSE GOUPILLE «AIR» SET 5 TAILLES



5 pcs	g	Ref.	☐
	725	7248040010	1

## JEU 4 CHASSE-AXES «AIR» 10/12/14/16MM

10/12/14/16mm.



10/12/14/16mm	L mm	g	Ref.	☐
	300	1780	7262040010	1

## STAND METAL 5 CHASSE-GOUPILLES AVEC POIGNÉE 3/4/5/6/8



5 pcs	Ø mm	g	Ref.	☐
	3-4-5-6-8	705	7261010001	1



## COFFRET DE 5 CHASSE-GOUPILLES

Avec poignée Air-grip à  
rondelle pare faux-coups  
Ø45 mm - corps rond  
bruni // longueur :  
- Ø3 : L145 mm  
- Ø4 : L180 mm  
- Ø5 : L185 mm  
- Ø6 : L205 mm  
- Ø8 : L225 mm



	Ø mm	g	Ref.	
5 pcs	3-4-5-6-8	700	7266000010	1

## COFFRET DE 6 CHASSE-GOUPILLES

Avec poignée Air-grip  
- L150 mm - acier CRV  
octogonal grenailé.



	Ø mm	g	Ref.	
6 pcs	2-3-4-5-6-8	610	7266010001	1

## CHASSE-GOUPILLES DE MÉCANICIEN HEXAGONALES

Corps hexagonal.  
Acier chrome vanadium.



Ø mm	S mm	L mm	g	Ref.	
10	12	150	95	7260100010	10
2	8	150	55	7260200010	10
3	8	150	55	7260300010	10
4	10	150	60	7260400010	10
5	10	150	60	7260500010	10
6	10	150	60	7260600010	10
7	12	150	60	7260700010	10
8	12	150	95	7260800010	10

## STAND DE 6 CHASSE-GOUPILLES

Corps hexagonal.  
Acier chrome vanadium.



	Ø mm	g	Ref.	
6 pcs	3-4-5-6-8-10	650	7261000010	1



## GRIFFE DE FERRAILLEUR

### UTILISATION

- Outil traditionnel du gros oeuvre en maçonnerie.
- Utilisé comme levier pour courber les fers à béton par les maçons ou par les ferrailleurs chargés du travail de l'acier sur le chantier.



### CARACTÉRISTIQUES

- Acier forgé monobloc haute qualité : «1 pièce» non soudé.
- Tailles adaptées pour chaque diamètre de fer, deux diamètres par griffe.



### QUALITÉ DE FINITION

- Peinture texturée, époxy, appliquée électrostatiquement et cuite au four  
= régularité de la surface de peinture  
= résistance aux chocs et à l'abrasion de la surface



## GRIFFE DE FERRAILLEUR HAUTE QUALITÉ

Pour courber les ronds à béton. Outil forgé et trempé monobloc haute qualité.

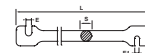

Ex E1 mm	L mm	S mm	g	Ref.	
6 x 8	300	14	220	0183060601	1
8 x 10	400	14	450	0183080601	1
10 x 12	500	16	750	0183100601	1
12 x 14	600	16	1000	0183120601	1
14 x 16	700	20	1600	0183140601	1
18 x 20	1000	25	4850	0183180601	1

## ÉQUERRE DE MAÇON

Angles vifs. Acier laqué.  
Section 30 x 5 mm.  
Assemblage à 90°  
(coupe d'onglet), pour une  
précision professionnelle



L cm	l cm	g	Ref.	
30	15	490	6265030001	1
40	20	670	6265040001	1
50	25	855	6265050001	1
60	30	1018	6265060001	1
80	40	1370	6265080001	1
100	50	1720	6265100001	1



16



62



96



120



126



156



188



224



248



254



300



316



340



390



462



488



489



# BROCHES ET CISEAUX DE MAÇON



## BROCHE DE MAÇON

La tête de sécurité est brevetée par Mob. Elle évite le champignonnage sous les coups répétés et les risques d'éclat. Elle protège partiellement la main. Système breveté.



### CARACTÉRISTIQUES

- Affûtables : acier à haute teneur en carbone C55 pour une très bonne longévité.
- La forge et le traitement thermique du tranchant confèrent un taillant agressif et résistant.



## BROCHE DE MAÇON

Pointerolle. Acier affûtable en pointe. Tête de sécurité exclusive.

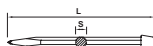

LxS mm	g	Ref.	Poignée adaptée	☐
250x14	320	7170250001	7312	5
250x16	400	7170260001	7311	5
300x16	480	7170310001	7311	5
300x18	550	7170320001	7311	5
350x16	570	7170360001	7311	5
350x18	710	7170370001	7311	5
400x16	650	7170410001	7311	5
400x18	810	7170420001	7311	5

## BROCHE DE MAÇON AVEC POIGNÉE

Pointerolle. Acier affûtable en pointe. Tête de sécurité exclusive. Poignée pare-coups.



LxS mm	g	Ref.	☐
250x14	390	7170250201	5
300x16	480	7170310201	5
350x16	570	7170360201	5

## BROCHE DE MAÇON, ACIER ALLIÉ

Pointerolle. Qualité "S". Acier manganèse silicium - réaffûtable.



LxS mm	g	Ref.	Poignée adaptée	☐
250x14	300	7100250001	7312	5
300x16	450	7100310001	7311	5
350x16	530	7100360001	7311	5
400x18	790	7100420001	7311	5

## BROCHE DE MAÇON A GORGES, ACIER ALLIÉ

À gorges - qualité "S" - acier manganèse silicium - réaffûtable Tête de sécurité exclusive



LxS mm	g	Ref.	Poignée adaptée	☐
250x14	290	7102250001	7312	5
300x16	460	7102310001	7311	5
350x16	520	7102360001	7311	5

## BROCHE DE MAÇON A GORGES, ACIER ALLIÉ, AVEC POIGNÉE

À gorges. Qualité "S". Acier manganèse silicium - réaffûtable. Tête de sécurité exclusive. Poignée pare-coups.

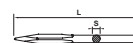

LxS mm	g	Ref.	☐
300x16	460	7102310201	5
350x16	520	7102360201	5



## CISEAU DE MAÇON

Tête de sécurité, qui évite le champignonage sous les coups répétés et les risques d'éclat. Elle protège partiellement la main. Système breveté.

### CARACTÉRISTIQUES

- Affûtables sur tranchant : acier à haute teneur en carbone C55 pour une très bonne durée de vie.
- Forgé et trempé pour une excellente résistance.



## CISEAU DE MAÇON

Acier affûtable sur tranchant.  
Tête de sécurité brevetée.

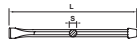

LxS mm	g	Ref.	Poignée adaptée	☐
250x14	320	7171250001	7312	5
250x16	380	7171260001	7311	5
300x16	500	7171310001	7311	5
300x18	620	7171340001	7311	5
350x16	580	7171360001	7311	5
350x18	720	7171370001	7311	5
400x18	840	7171420001	7311	5
500x18	1060	7171520001	7311	5

## CISEAU DE MAÇON AVEC POIGNÉE

Acier affûtable sur tranchant.  
Tête de sécurité exclusive. Poignée pare-coups.

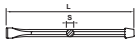

LxS mm	g	Ref.	☐
250x14	320	7171250201	5
300x16	500	7171310201	5
350x16	580	7171360201	5

## CISEAU DE MAÇON, ACIER ALLIÉ

Qualité "S". Acier manganèse silicium - réaffûtable.  
Tête de sécurité brevetée.

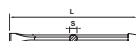

LxS mm	g	Ref.	Poignée adaptée	☐
250x14	310	7101250001	7312	5
250x16	400	7101260001	7311	5
300x16	490	7101310001	7311	5
350x16	550	7101360001	7311	5
400x18	800	7101420001	7311	5

## CISEAU DE MAÇON ACIER ALLIÉ, AVEC POIGNÉE

Qualité d'acier manganèse silicium réaffûtable à cœur.  
Tête de sécurité exclusive.  
Poignée pare-coups.

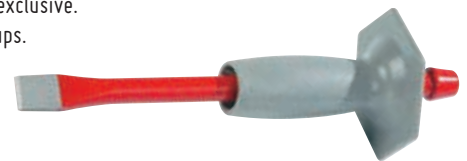
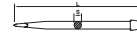

LxS mm	Section	g	Ref.	☐
250x14	Corps rond	350	7106250201	5
300x16	Corps rond	520	7106300201	5
300x16	Corps hexa	550	7101310201	5
350x16	Corps rond	580	7106350201	5
350x16	Corps hexa	880	7101360201	5
400x18	Corps rond	810	7106400201	5

## CISEAU DE MAÇON NERVURÉ, ACIER ALLIÉ

Qualité "S". Acier manganèse silicium - réaffûtable.  
Tête de sécurité exclusive.

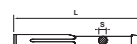

LxS mm	g	Ref.	Poignée adaptée	☐
300x16	470	7103310001	7311	5
350x16	530	7103360001	7311	5



16



62



96



120



126



156



188



224



248



254



300



316



340



390



462



488



# BROCHES ET CISEAUX DE MAÇON



## CISEAU À BRIQUE

- Tête de sécurité brevetée
- Acier forgé trempé à forte teneur en carbone C55, affûté sur tranchant



## CISEAU À BRIQUE

Acier affûté sur tranchant.  
Tête de sécurité exclusive.

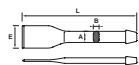

l mm	L mm	Section mm	g	Ref.	Poignée adaptée	☐
40	205	20x10	260	7175400001		5
50	210	22x11	320	7175500001	7311	5
60	210	22x11	340	7175600001	7311	5
70	220	25x12	440	7175700001	7313	5
80	220	25x12	470	7175800001	7313	5
100	225	26x13	590	7175910001	7313	5

## CISEAU À BRIQUE AVEC POIGNEE

Acier affûté sur tranchant.  
Tête de sécurité exclusive.

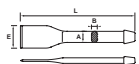

l mm	L mm	Section mm	g	Ref.	☐
50	210	22x11	320	7175500201	5
60	210	22x11	340	7175600201	5
70	220	25x12	440	7175700201	5
80	220	25x12	470	7175800201	5

## CISEAU D'ÉLECTRICIEN OU DE CARRELEUR

Acier affûté sur tranchant.  
Tête de sécurité exclusive.

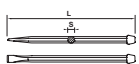

L mm	S mm	g	Ref.	☐
200	10	130	7245200001	10
250	10	170	7245250001	10

## BROCHE D'ÉLECTRICIEN OU DE CARRELEUR

Réaffûté

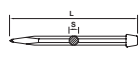

L mm	S mm	g	Ref.	☐
150	10	105	7172150001	10
200	10	140	7172200001	10

## CISEAU DE CHARPENTIER

Acier affûté sur tranchant.  
Tête de sécurité exclusive.

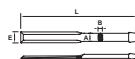

E mm	L mm	A mm	B mm	g	Ref.	☐	Ref.	☐
20	275	16	8	220	7035200001	5	7035201001	5
25	300	18	9	300	7035250001	5	7035251001	5
30	350	22	11	510	7035300001	5	7035301001	5
35	375	25	12	740	7035350001	5	7035351001	5
40	400	26	13	820	7035400001	5	7035401001	5

## BURIN DE CARRELEUR

Réaffûté.



L mm	S mm	g	Ref.	☐
80	10	32	7173000001	10

## CHASSE À PIERRE

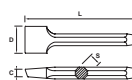

D mm	C mm	L mm	S mm	g	Ref.	☐
45	12	205	20	640	0161450601	1

## RIFLARD MONOBLOC - CHASSE À DÉGRAFER

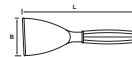

B mm	L mm	g	Ref.	☐
70	220	400	0360000610	1

## RIFLARD DE MAÇON

Permet de gratter les enduits et plâtres, décaper. Lame épaisse biseautée en acier trempé. Embase forgée virole laiton. Manche hêtre

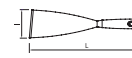

L mm	l mm	g	Ref.	☐
70	260	190	6360000010	1

## GRATTOIR TRIANGULAIRE

Utilisé pour élargir les fissures avant rebouchage ou enlever les anciens joints. Lame biseautée.



Côtés cm	g	Ref.	☐
8	155	6232080010	3



## CHEVILLE

### VALET

- Valet nervuré pour une plus grande longévité.
- Dégagement supérieur. Pied arrondi multi-prise.

### POINTE

- Pointe dite en grain d'orge : angle d'attaque à 35°, angle de pénétration à 11°.
- Trempe localisée puis opération de revenu pour une dureté élevée des parties travaillantes (50-56 Hrc).
- Excellente attaque y compris en terrain difficile et grande longévité.

### QUALITÉ D'ACIER

- Acier à forte teneur en Carbone : C45 pour le valet, C55 forgé pour la pointe.
- Affûtabilité en pointe, très bon rendement et excellente durée de vie.

### QUALITÉ DE FINITION

- Peinture texturée, époxy, appliquée électrostatiquement et cuite au four.
- Résistance aux chocs et à l'abrasion de la surface.



## CHEVILLE DE MAÇON RONDE

Section ronde Ø10.  
Valet forgé et nervuré.  
Pointe en grain d'orge.

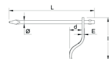

L mm	Ø mm	D mm	E mm	l mm	g	Ref.	☐
200	10	35	7	120	249	7160200001	10
250	10	35	7	120	280	7160250001	10
300	10	35	7	120	311	7160300001	10

## CHEVILLE DE MAÇON CARRÉE

Section carrée 10 mm.  
Idéale pour tenir des règles.  
Valet forgé et nervuré.  
Pointe en grain d'orge.

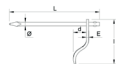

L mm	Ø mm	d mm	E mm	l mm	g	Ref.	☐
250	10	35	7	120	322	7162250001	10
300	10	35	7	120	361	7162300001	10

## CHEVILLE DE MAÇON OCTOGONALE

Section octogonale.  
Valet forgé et nervuré.  
Pointe en grain d'orge.

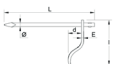

L mm	Ø mm	d mm	E mm	l mm	g	Ref.	☐
200	10	35	7	120	255	7164200001	10
250	10	35	7	120	288	7164250001	10
300	10	35	7	120	320	7164300001	10

## CHEVILLE DE BRIQUETEUR

Avec tête de sécurité.



L mm	S mm	g	Ref.	☐
150	10	90	7166150001	10

## SERRE-JOINT RAPIDE

Même construction que les chevilles mais à 2 côtés comme un serre-joint. Plus léger et maniable. Idéal pour les coffrages de dimension moyenne. Carré de 10. Breveté.



C mm	D mm	L mm	g	Ref.	☐
400	120	500	625	7165400001	5
600	120	700	780	7165600001	5





# SERRE-JOINT ET CHEVILLETES



## ÉTRIER DE COFFRAGE

### UTILISATION

- Permet la réalisation de coffrage, linteau, dessus de mur, longrine, de largeur 200 mm.
- S'utilise avec des planches de coffrage d'épaisseur 27 mm.



### ÉTRIER DE COFFRAGE

Tube carré de 20 mm.  
Assemblage boulonné.  
Référence Mondelin.



	g	Ref.	
<b>200</b>	2600	309500	10

### ÉTRIER DE COFFRAGE SÉRIE ÉCO

Tube carré de 30 mm.  
Assemblage par sertissage.  
Référence Mondelin.



	g	Ref.	
<b>200</b>	2130	309510	10



## SERRE-JOINT DE MAÇON

### UTILISATION

- Maintenir les planches de coffrage
- Les serre-joints sont enlevés à la masse ou à la massette, ils doivent donc être résistants et durables, sans soudure et avec des sections fortes.

### CARACTÉRISTIQUES

- Entièrement forgés, sans soudure.
- Grande résistance aux chocs.
- Finition peinture grise
- Section 8 mm pour les serre joints de saillie 175 mm et 7 mm pour les 135 mm
- La saillie désigne la profondeur, 135 ou 175 mm.
- Les différentes longueurs permettent de s'adapter à la largeur du coffrage : 400 à 1000 mm.



### SERRE-JOINT DE MAÇON 175

Tête forgée quadrillée.

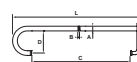

C mm	D mm	L mm	AxB mm	g	Ref.	
<b>400</b>	175	600	30 x 8	2540	6399400001	2
<b>600</b>	175	800	30 x 8	2940	6399600001	2
<b>800</b>	175	1000	30 x 8	3330	6399800001	2

### SERRE-JOINT DE MAÇON 135

Tête forgée quadrillée.

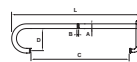

C mm	D mm	L mm	AxB mm	g	Ref.	
<b>600</b>	135	800	30 x 7	2300	6398600010	2
<b>800</b>	135	1000	30 x 7	2600	6398800010	2
<b>1000</b>	135	1200	30 x 7	3000	6398990010	2





## GORILLA BAR

### SOLIDITÉ

- Acier forgé monobloc = grande rigidité.
- Traitement thermique des extrémités = résistance et durabilité supérieure (45 HRC de dureté).
- Forte section dans le sens de l'effort = puissance extrême.

### ACCESSIBILITÉ ET PERFORMANCE

- Angle étudié pour travailler en toute situation contrairement à une barre classique qui nécessite un fort dégagement.
- = efficace même avec des pièces verticales de grande hauteur.
- = laisse la place pour la main. = excellent rapport poids/puissance.
- Confort : Corps ovale adapté à votre main
- = prise plus ferme.
- = ergonomie même avec un appui important.



**GORILLA BAR**



Laisse la place pour la main

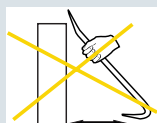
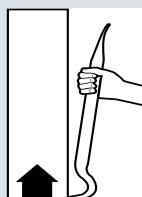

Pointes biseautées pour plus d'efficacité : se glisse partout.

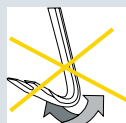
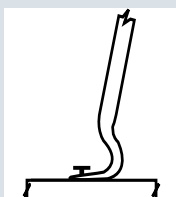

Extrémités stables



### GORILLA BAR

Corps ovale de section forte.  
Extrémités larges et effilées  
avec protection plastique.



L mm	Section mm	l mm	g	Ref.	☐
350	20x14	30	680	7187350010	1
600	30x20	40	2100	7187600010	1
900	30x20	42	3200	7187900010	1

### LOTS DE GORILLA BAR

- Jeu de 2 pièces : 350, 600 mm
- Jeu de 3 pièces : 350, 600, 900 mm.



	g	Ref.	☐
350 - 600 - 900	6300	0112010123	1
350 - 600	2950	0112010012	1



16



62



96



120



126



156



188



224



248



254



300



316



340



390



462



488



# OUTILS DE LEVAGE ET DE COFFRAGE



## PINCE À DÉCOFFRER

### UTILISATION

- Pour faire lever et décoffrer, arracher les clous.
- 1 côté pince et 1 côté arrache-clous avec col de cygne.



### CARACTÉRISTIQUES

- La forme du col de cygne permet un bras de levier puissant avec peu de mouvement nécessaire.
- Acier à haute teneur en carbone C55.
- Extrémités forgées et trempées, pour une plus longue longévité (dureté 55 HRC +/-3).
- Peinture rouge époxy cuite au four, épaisseur garantie, pour une bonne tenue dans le temps.



Côté pince



Arrache-clou



Côté col de cygne



## PINCE À DÉCOFFRER

1 côté arrache clou robuste, 1 côté pour faire levier et décoffrer.

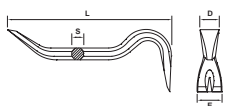

L mm	Section mm	E mm	D mm	g	Ref.	
400	16	30	27	750	7181400001	3
500	16	30	27	900	7181500001	3
600	18	35	29	1300	7181600001	3
700	18	35	29	1500	7181700001	3
800	20	39	34	2200	7181800001	3
1000	20	39	34	2800	7181910001	1
1200	20	39	34	3300	7181920001	1

## PINCE À DÉCOFFRER «CATALOGNE»

Modèle « Catalogne ».

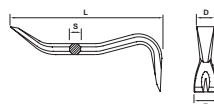

L mm	Section mm	E mm	D mm	g	Ref.	
500	16	35	30	1100	7184500001	1
600	18	35	30	1300	7184600001	1
700	18	35	30	1550	7184700001	1
800	20	39	34	2150	7184800001	1
1000	20	39	34	2700	7184910001	1



## PINCE MONSEIGNEUR OU DE DEBALLEUR

1 levier biseau,  
1 levier recourbé avec  
arrache-clou.

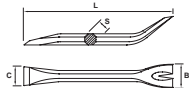

L mm	Section mm	E mm	D mm	g	Ref.	∅
300	14	29	25	350	7185300001	3
400	16	32	27	650	7185400001	3
500	16	32	27	800	7185500001	3
600	18	34	30	1200	7185600001	3
700	20	37	34	1700	7185700001	3
800	20	39	34	2000	7185800001	3
1000	20	39	34	2500	7185910001	1
1200	20	39	34	3000	7185920001	1

## BROCHE DE MONTEUR

Les pointes permettent  
d'aligner les trous pour le  
montage de structures.

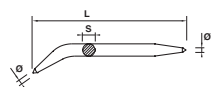

L mm	Section mm	Ø mm	g	Ref.	∅
420	13	6	400	7230000001	1

## ARRACHE-CLOUS "Z"

1 côté « pied de biche »,  
1 côté arrache-clous  
classique.



L mm	Section mm	g	Ref.	∅
400	14	615	7192400001	1
500	16	970	7192500001	1

## ARRACHE-CLOUS "Z"

Double « pied de biche ».

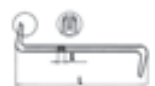

L mm	Section mm	g	Ref.	∅
350	14	500	7191350001	1
400	14	615	7191400001	1

## PINCE DE MONTEUR

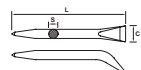

L mm	S mm	C mm	g	Ref.	∅
400	16,5	27	650	0334400601	1
500	18	29	900	0334500601	1
600	20	33	1400	0334600601	1

## ARRACHE CLOU NAILEXPRESS

Type japonais.  
Extrémités usinées.  
La partie coudée est munie  
d'un talon qui peut servir  
de petit marteau.



L mm	Ref.	∅
305	0116010012	1



## BIBER BAR

### PLAT ET FIN

- Sa grande finesse lui permet de se glisser facilement entre 2 pièces de bois.
- Sa largeur permet de séparer les pièces de bois sans les abimer.

### ARRACHE-CLOUS

- 3 arrache-clous pour travailler en toute situation.

### CARACTÉRISTIQUES

- Acier Manganèse Silicium : permet une grande résistance malgré sa finesse.



## BIBER - BAR

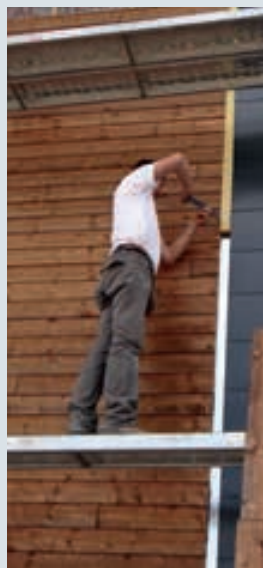

## BIBER BAR

Arrache-clou plat.  
Acier manganèse silicium.



## BIBER - BAR



L mm	B mm	E mm	D mm	g	Ref.	∅
375	7	50	40	725	0113010015	1



16



62



96



120



126



156



188



224



248



254



300



316



340



390



462



488



## PINCE À TALON

### UTILISATION

Les pinces à talon permettent de faire levier, pour déplacer, riper, soulever, positionner ou caler des charges lourdes.

### FABRICATION

L'acier choisi est un acier fortement chargé en Carbone. Ces grands produits sont réalisés traditionnellement chez Mob en «forge libre», c'est donc le forgeron qui réalise à la main et unitairement la forme voulue. Ce travail demande un regard averti, une rigueur de réalisation, et une bonne condition physique. C'est la quintessence du métier de forgeron.

### FINITION

Une nouvelle chaîne de peinture époxy pour les produits longs à vu le jour en 2018, pour une qualité accrue et un meilleur respect de l'environnement.



Forge libre Mob



Ligne de peinture du Chambon

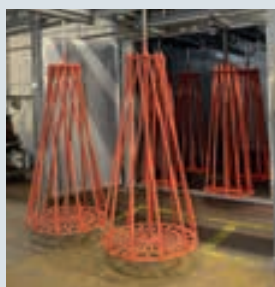

Utilisation pointe



### PINCE À TALON

Ronde avec 1 taillant courbé et 1 taillant droit. Pour faire levier et soulever, riper, positionner, déplacer ou encore caler les bandes de coffrage.

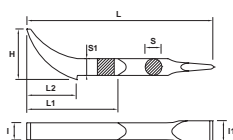

L m	L1 mm	L2 mm	S mm	S1 mm	H mm	l mm	l1 mm	kg	Ref.	☐
0,50	160	60	20	28	50	28	25	1,6	0150050601	1
0,75	250	75	24	28	65	33	30	3,2	0150070601	1
1	300	80	27	32	70	36	38	5	0150100601	1
1,25	350	100	30	38	80	39	40	8,5	0150120601	1
1,50	400	110	33	40	90	42	44	12	0150150601	1

### PINCE À TALON

Avec 1 taillant courbé et 1 pointe. Talon utilisé pour faire levier avec appui au sol, déplacer des charges lourdes dans le bâtiment.

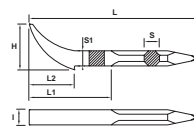

L m	L1 mm	L2 mm	S mm	S1 mm	H mm	l mm	kg	Ref.	☐
0,50	160	60	20	28	50	28	1,6	0149050601	1
0,75	250	75	24	28	65	33	3,2	0149070601	1
1	300	80	26	32	70	36	5	0149100601	1
1,25	350	100	30	38	80	39	8,5	0149120601	1
1,50	400	110	31	40	90	42	12	0149150601	1
1,75	450	150	33	42	105	55	16	0149170601	1



## PINCE DE PAVEUR



Corps rond.  
1 côté flamme de faible largeur.  
1 côté tête ronde.



L m	Section mm	l mm	kg	Ref.	☐
1,50	25	30	5,5	0148000601	1

## PINCE À RIPER



Corps rond.  
1 côté pointe,  
1 côté tête ronde.



L m	Section mm	kg	Ref.	☐
1,20	30	6,5	0153000601	1

## BARRE À MINE



Section hexagonale. Un côté pointe pour creuser et un côté flamme pour tailler et faire levier. Dureté des extrémités : 55HRC (+/-3).



L m	Section mm	l mm	kg	Ref.	☐
1	22	38	3	0152100001	1
1,25	22	38	3,85	0152120001	1
1,50	25	40	5,70	0152150001	1
1,75	28	45	8,70	0152170001	1
2	28	45	10	0152200001	1

## BARRE À MINE À PALETTE



Section hexagonale. Un côté pointe pour creuser et un côté palette pour trancher, faire levier, déplacer des charges, déchausser des pierres, déplanter.



L m	Section mm	largeur palette mm	kg	Ref.	☐
1,20	16	120	1,9	0151120001	1
1,20	20	135	3	0151130001	1
1,60	20	135	4	0151150001	1
1,60	25	150	6,3	0151160001	1
1,80	25	150	7,2	0151180001	1



## TWIN BAR

### PLUS DE LARGEUR

- Sa double prise permet de prendre un meilleur appui par rapport aux autres barres de levage. Elle est donc plus rapide.
- Elle permet aussi de démonter sans casser.

### UTILISATIONS



- Arrache les planchers.
- Démonte les palettes.
- Soulève les menuiseries.

### ERGONOMIE

- Sa grande hauteur (plus d'un mètre) permet de travailler debout sans fatigue.

### DESRIPTIF

- Structure métallique.
- Arrache-clou.
- Manche bi-matière.
- Fourches trempées (55 HRC).

TMS

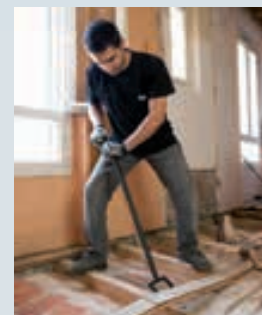

## TWINBAR DOUBLE FOURCHE DE LEVAGE

- Démonte les palettes.
- Arrache les planchers.
- Soulève les menuiseries.



L mm	l mm	g	Ref.	☐
1085	135	2600	7188100001	1



16



62



96



120



126



156



188



224



248



254



300



316



340



390



462



488





# 011

## ACCÈS EN HAUTEUR TRÉTEAUX

**P.302**  
| ESCABEAUX  
ALUMINIUM 4S



**P.308**  
| MARCHEPIEDS  
ALUMINIUM



**P.309**  
| MARCHEPIEDS  
ACIER



**P.312**  
| PLATEFORME  
NINJA



**P.306**  
| ESCABEAUX  
ACIER



**P.310**  
| MARCHEPIED  
MULTI



**P.313**  
| PLATEFORME  
ALUMINIUM



**P.314**  
| TRÉTEAUX





# ESCABEAUX ALUMINIUM



## ESCABEAUX ALUMINIUM À ASSEMBLAGE TENON-MORTAISE

Extrêmement robuste, à marches caillebotis et rampe d'accès.

### CARACTÉRISTIQUES TECHNIQUES

- Conforme aux exigences de sécurité du décret 96 333 du 10/04/1996 et à la norme EN 131
- Charge maximale d'utilisation : 150 kg
- Marches caillebotis en aluminium moulé 90 x 370 x 25 mm
- Profils aluminium épaisseur 2 mm
- Tablette porte-outils en bois antidérapant 320 x 360 x 9 mm
- Plateforme de travail en bois antidérapant 320 x 300 x 9 mm
- Fabriqué en France



### SOLIDITÉ

Grande robustesse, pour utilisation intensive et grande durée dans le temps.

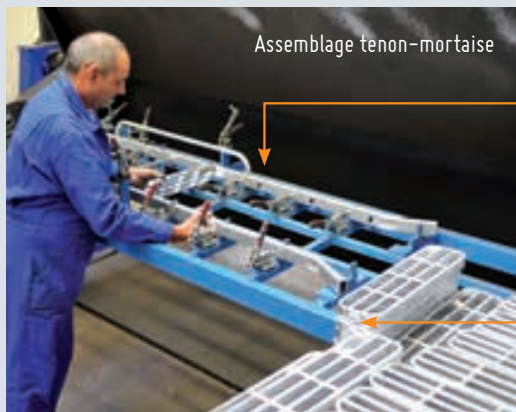

Encastrement mécanique tenon-mortaise extrêmement robuste et anti-rotation.



Soudure robotisée pour un cordon toujours identique.

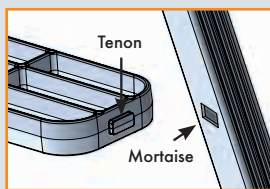

Double assemblage innovant par tenon-mortaise et soudure.

### PALIERS NYLON/ACIER

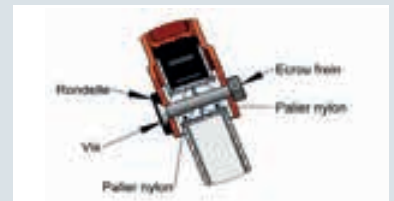

Articulations pourvues de paliers en nylon/acier, pour éviter l'usure et la prise de jeu.

### SÉCURITÉ

Rampe et marches caillebotis.



Rampe servant de main courante qui sécurise la montée sur l'escabeau.



La rampe sert également de garde-corps pendant le travail.



Marches caillebotis moulées en aluminium, larges de 90 mm pour un meilleur confort de travail, anti-dérapantes et faciles à nettoyer.



Système de verrouillage : position ouverte sécurisée (anti-soulèvement).



# ESCABEAUX ALUMINIUM



## STABILITÉ



Patins antidérapants enveloppants pour une grande stabilité.



Double blocage mécanique à l'ouverture par accrochage de la tablette et appui des montants.



Évasement côté montée.

**4S**  
SIMPLE À UTILISER  
SOLIDE STABLE SÛR



## SIMPLICITÉ

Escabeau léger, facilement repliable et transportable.



Légèreté de l'aluminium. Excellente préhension grâce aux montants striés.



Tube arrière surélevé de H540mm en cas d'obstacle (toilettes), ceci sur toute la gamme.



Montants peints, «mains propres», pour se simplifier la vie.

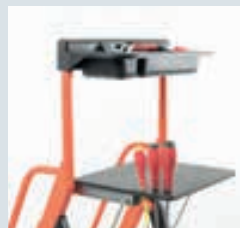

Tablette porte-outil 320x360 et porte-outil amovible permettant de déposer outils et matériel.



Tablette pratique pour déposer une caisse à outils.



16



62



96



120



126



156



188



224



248



254



300



316



340



390



462



488



303



# ESCABEAUX ALUMINIUM 4S



## ESCABEAUX ALUMINIUM À ASSEMBLAGE TENON-MORTAISE

### LES PLUS

- Assemblage extrêmement robuste par encastrement tenon-mortaise et soudure robotisée
- Escabeaux en aluminium, légers, facilement repliables et transportables
- Marches caillebotis larges : 90 mm
- Rampe de sécurité



TABLETTE PORTE-OUTILS  
en bois antidérapant  
320 x 360 x 9 mm

FERMETURE AUTOMATIQUE  
de la tablette et de la plateforme,  
au pliage de l'escabeau

PLATEFORME DE TRAVAIL  
en bois antidérapant  
320 x 300 x 9 mm

SYSTÈME DE VERROUILLAGE  
EN POSITION OUVERTE

PERMET D'ENJAMBER  
LES CUVETTES DES TOILETTES  
Hauteur 540 mm

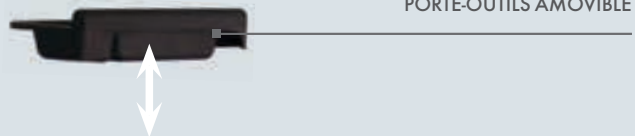

HAUTEUR DE PASSAGE  
SOUS LE GARDE-CORPS : 300 mm

MARCHES  
CAILLEBOTIS  
aluminium moulé  
grand confort  
90 x 370 x 25 mm

110 cm - 201970

ASSEMBLAGE COMPLET  
par tenon-mortaise et soudage  
assurant une grande longévité

PATINS ANTIDÉRAPANTS  
pour une stabilité optimale

CONFORME  
À LA NORME

**EN  
131**

Conforme aux exigences  
de sécurité du décret  
96 333 du 10/04/1996  
et à la norme EN 131



# ESCABEAUX ALUMINIUM 4S



Roger  
**MONDELIN**

## GAMME ESCABEAUX ALUMINIUM À ASSEMBLAGE TENON-MORTAISE

**4S**  
SIMPLE À UTILISER  
SOLIDE STABLE SÛR

70 cm - 201950

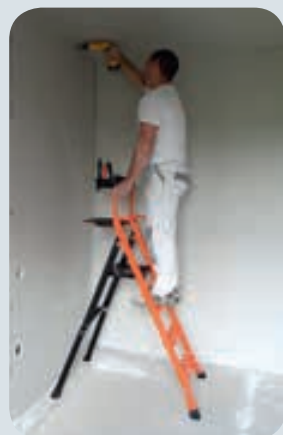

**PLAQUISTE**

90 cm - 201960



**ÉLECTRICIEN**

110 cm - 201970

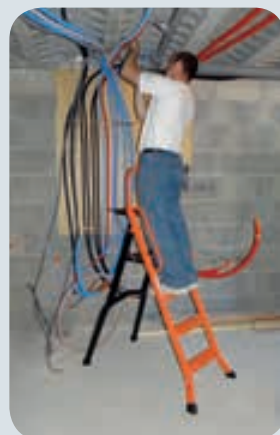

**CHAUFFAGISTE**

140 cm - 201980

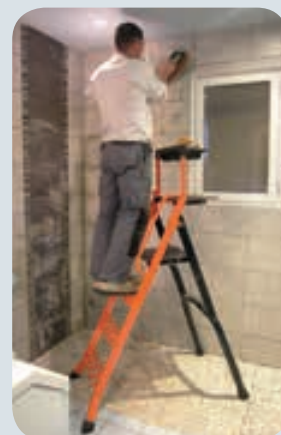

**CARRELEUR**

### ESCABEAUX PRO ALUMINIUM À ASSEMBLAGE TENON-MORTAISE

Tubes et marches aluminium.  
Marches caillebotis.  
Peinture époxy. Rampe de sécurité.  
Charge utile : 150 kg quelque  
soit le modèle.  
Conforme à la norme EN131.  
Porte-outils amovible compris.



### PORTE-OUTILS AMOVIBLE SEUL



Ref.	📦
201955	1

Hauteur plateforme cm	Nbre de marches y compris plateforme	Hauteur de travail maxi cm	Hauteur porte-outils cm	Hauteur replié cm	Charge utile kg	📐 kg	Empattement cm	Ref.	📦
70	3	270	103	145	150	9	82 x 58	201950	1
90	4	290	126	170	150	10,2	102 x 58	201960	1
110	5	310	150	196	150	11,6	120 x 58	201970	1
140	6	340	173	221	150	12,7	140 x 58	201980	1



16



62



96



120



126



156



188



224



248



254



300



316



340



390



462



488



# ESCABEAUX PRO ACIER LESCABO



**MONDELIN**

## ESCABEAUX PRO ACIER LESCABO

### LES PLUS

- Marches caillebotis extra-larges 130 mm
- Escabeaux facilement repliables

**LESCABO<sup>®</sup> acier**



PORTE-OUTILS AMOVIBLE



HAUTEUR DE PASSAGE  
SOUS LE GARDE-CORPS : 340 mm

TABLETTE PORTE-OUTILS 320 x 360 x 9 mm  
en bois antidérapant

FERMETURE AUTOMATIQUE DE LA TABLETTE  
et de la plateforme, au pliage de l'escabeau

SYSTÈME DE VERROUILLAGE EN  
POSITION OUVERTE

PLATFORME DE TRAVAIL 320 x 300 x 9 mm  
en bois antidérapant

MARCHES CAILLEBOTIS  
de 400 x 130 x 25 mm

PATINS ANTIDÉRAPANTS

CONFORME  
À LA NORME

**EN  
131**

Conforme aux exigences  
de sécurité du décret  
96 333 du 10/04/1996  
et à la norme EN 131



# ESCABEAUX PRO ACIER LESCABO



Roger

**MONDELIN**

## GAMME LESCABO ESCABEAUX ACIER

### LESCABO® acier

70 cm - 201900



90 cm - 201910



140 cm - 201930



110 cm - 201920

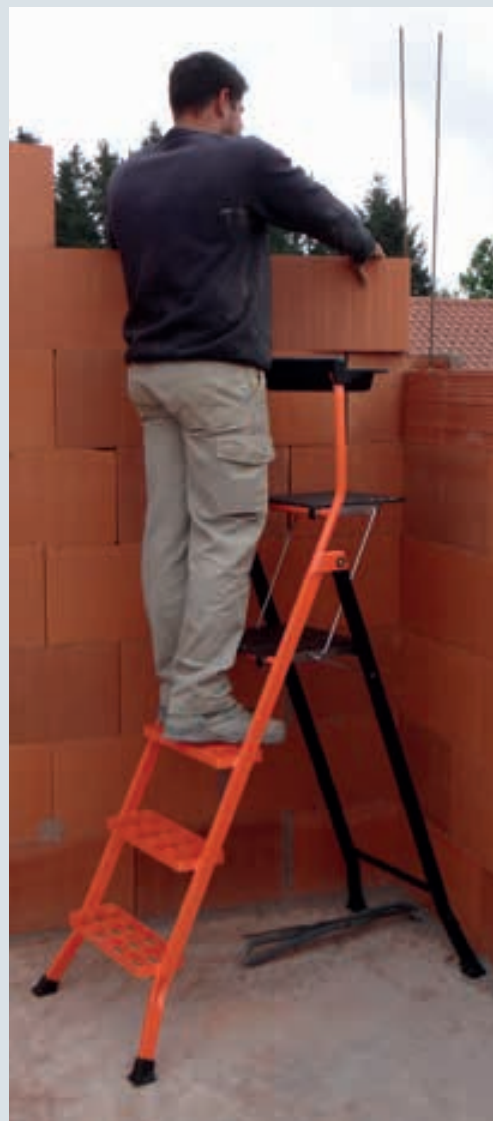

### ESCABEAUX PRO ACIER LESCABO® MARCHES CAILLEBOTIS

Tubes et marches acier. Peinture époxy.  
Charge utile : 150 kg quelque soit le modèle.  
Conforme à la norme EN131.  
Porte-outils amovible fourni.



### PORTE-OUTILS AMOVIBLE SEUL



Ref.	📦
201955	1

Hauteur plateforme cm	Nbre de marches y compris plateforme	Hauteur de travail maxi cm	Hauteur porte-outils cm	Hauteur replié cm	Charge utile kg	👤 kg	Empattement cm	Ref.
70	3	270	138	150	150	11,6	86 x 59	201900
90	4	290	161	175	150	13,7	105 x 59	201910
110	5	310	184	200	150	16	125 x 59	201920
140	6	340	207	225	150	18,1	144 x 59	201930

-  16
-  62
-  96
-  120
-  126
-  156
-  188
-  224
-  248
-  254
-  300
-  316
-  340
-  390
-  462
-  488



## MARCHEPIED ALUMINIUM MARCHES CAILLEBOTIS

### LES PLUS

- Assemblage robuste par encastrement tenon-mortaise et soudure robotisée
- 2 marches caillebotis en aluminium moulé : larges et faciles à nettoyer
- Léger 5,7 kg, facilement repliable et transportable
- Excellente préhension grâce aux montants striés
- Système de verrouillage en position ouverte pour une sécurité accrue.

### CARACTÉRISTIQUES

- Conforme à la norme EN131
- Plateforme en bois antidérapant, épaisseur 9 mm, dimensions 260 x 365 mm
- Marches en aluminium moulé et profils aluminium épaisseur 2 mm
- Patins antidérapants
- Peinture époxy



CONFORME A LA NORME

**EN 131**



Transport facile grâce à la poignée



Patins antidérapants



### MARCHEPIED PLIANT ALUMINIUM AVEC MARCHE CAILLEBOTIS

2 marches caillebotis en aluminium moulé : 370 x 90 x 25 mm.  
Hauteur 70 cm. Poids 5,7 cm.  
Plateforme en bois antidérapant, épaisseur 9 mm.  
Patins antidérapants. Conforme à la norme EN131.



Hauteur cm	Charge utile kg	Poids kg	Ref.	Quantité
70	150	5,7	201700	1



## ROGER MONDELIN MARCHEPIED ACIER MARCHES CAILLEBOTIS

### LES PLUS

- Marches extra-larges 130 mm confortables et faciles à nettoyer
- Facilement repliable et transportable grâce à la poignée de transport
- Patins antidérapants
- Plateforme supérieure en bois antidérapant, 260 x 365 x 9 mm



201740  
70 cm

CONFORME A LA NORME

**EN 131**



201760  
90 cm

### MARCHEPIED PLIANT ACIER MARCHES CAILLEBOTIS

Peinture époxy.  
Conforme à la norme EN131.



Hauteur cm	Charge utile kg	kg	Ref.	☐
70	150	8,8	201740	1
90	150	11	201760	1

## ROGER MONDELIN MARCHEPIED ACIER MARCHES BOIS

### LES PLUS

- Marches sapin antidérapantes striées 40 x 13 x 2 cm
- Facilement repliable et transportable grâce à la poignée.
- Patins antidérapants
- Plateforme supérieure en bois antidérapant 260 x 365 mm x 9 mm



201770  
70 cm

CONFORME A LA NORME

**EN 131**



201800  
90 cm

### MARCHEPIED PLIANT ACIER MARCHES BOIS

Tubes acier.  
Peinture époxy.  
Conforme à la norme EN131.



Hauteur cm	Charge utile kg	kg	Ref.	☐
70	150	8,5	201770	1
90	150	11,2	201800	1



16



62



96



120



126



156



188



224



248



254



300



316



340



390



462



488

# MARCHEPIED MULTI

Roger  
**MONDELIN**

**MULTI : MARCHEPIED MULTIFONCTION**

## LES PLUS

1 seul outil – plusieurs utilisations

le **m**archepied avec tablette  
support de coupe  
plan de travail  
tréteaux  
**MONDELIN**

- Bras pivotant pour passer de l'utilisation marchepied à la position tréteaux
- Plan de travail, support de coupe ou tréteau
- Avec tablette porte-outils rotative escamotable
- Léger : 9kg
- Fabriqué en France
- Garantie 5 ans

Retrouvez la Vidéo :



**MULTI**



CONFORME  
A LA NORME

**EN  
131**

## UTILISATIONS

1

### MARCHEPIED

- Dernière marche à 47cm du sol.
- Hauteur d'accès 2,47m.
- Avec tablette réversible pour avoir ses outils à portée de main.



2

### SUPPORT DE COUPE

- Pour les petites sections grâce au blocage du bras en position fermée (Tiges filetées, tuyau cuivre...).
- Pour les grosses sections avec le bras en position ouverte (Tubes PVC, bois...) - 50 kg maxi



3

### PLAN DE TRAVAIL

- Hauteur de travail à 90 cm du sol, parfaitement ergonomique
- 4 points d'appui anti-dérapants avec patins caoutchouc.
- Charge maxi 50 kg.



4

### TRÉTEAUX

- Pour les grandes surfaces de travail
- 4 points d'appui anti-dérapants avec patins caoutchouc latéraux.
- Hauteur de travail à 70 cm du sol.







### TABLETTE RÉVERSIBLE

- En position extérieure lorsque le MULTI est utilisé en marche-pied, elle permet d'avoir à portée de mains ses outils ou des pots d'enduit, de peinture...
- Tablette antidérapante
- Emplacements pour tournevis ou mélangeur

- La tablette peut aussi s'utiliser et se verrouiller en position intérieure
- Pratique : des rebords permettent de poser des outils, des petites pièces ou de la visserie sans risque de les faire tomber
- Emplacements toujours disponibles pour les tournevis ou les mélangeurs

**multi**

### MARCHE CAILLEBOTIS

- La marche caillebotis antidérapante permet de mieux évacuer les résidus éventuels = Montée plus sûre
- Marche profonde de dimensions 370x90x25mm = Confort de montée et de descente assuré



### TRANSPORT FACILITÉ

- Pliage rapide et fluide
- Facile à transporter : seulement 9kg
- Encombrement réduit : Dimension plié de 1040x705x170mm
- Rentre dans le coffre d'une voiture

### CONSTRUCTION ROBUSTE

- Assemblage robuste par encastrement tenon-mortaise et soudure robotisée de la marche et des profils en aluminium assurant une excellente rigidité
- Articulation du piètement et des tablettes avec paliers renforcés
- Aluminium d'épaisseur 2mm

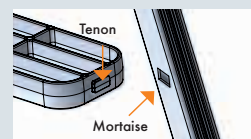

### STABILITÉ OPTIMALE

- Double blocage mécanique à l'ouverture par accrochage de la plateforme et appui des montants
- Stabilité parfaite au sol grâce aux 4 patins caoutchouc antidérapants

## MULTI, MARCHEPIED MULTIFONCTION



16



62



96



120



126



156



188



224



248



254



300



316



340



390



462



488

Hauteur plateforme cm	Hauteur de travail maxi cm	Dim. repliée	kg	Ref.	
47	247	1040x705x170	9	201830	1

# PLATEFORME NINJA

Roger  
**MONDELIN**

PLATEFORME NINJA

## LES PLUS

- Garde-corps verrouillés pour plus de sécurité
- Montage rapide en 1 minute
- 7 hauteurs de travail
- Plateforme large de 93cm
- PIRL fabriquée en France
- Garantie 5 ans
- Poids : 29,5 kg
- Charge maximum : 150 kg
- Largeur 69 cm : passage dans une porte
- En acier peint



## SÉCURITÉ ASSURÉE

- Pieds et garde-corps verrouillés
- Marches caillebotis acier confortables et profondes
- 4 pieds stabilisateurs fixes

## CONFORT DE TRAVAIL OPTIMAL

- Plateforme large de 93 cm en contreplaqué anti-dérapant
- Plinthes anti-chute
- Portillon avec blocage mécanique
- Augette amovible pour avoir ses outils à portée de main



Retrouvez la Vidéo :



Montage rapide  
en 1 minute, 3 pièces seulement



Transport facile

7 hauteurs de travail,  
s'adapte à tous les chantiers

Garde-corps et pieds verrouillés  
pour une sécurité optimale

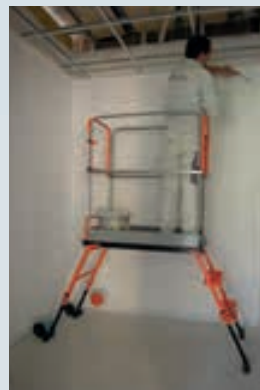
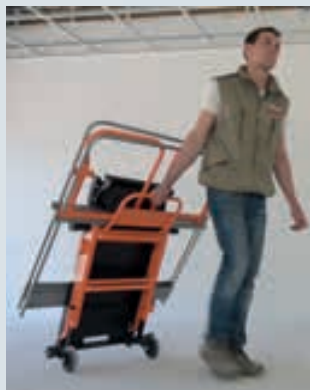

Plateforme large de 93 cm  
En contreplaqué antidérapant





## PLATEFORME NINJA

- Plateforme individuelle roulante légère avec garde-corps.
- Montage rapide en 1 minute.
- 7 hauteurs de travail.
- Verrouillage des garde-corps.
- Plateforme large de 93cm.
- Marches caillebotis en acier largeur 130 mm.



kg	Ref.	
29,5	500610	1



**MONDELIN**

## PLATEFORME DE TRAVAIL ALUMINIUM

### INNOVATION

- Plateforme légère, facilement repliable et transportable
- Assemblage complet par tenon-mortaise et soudage assurant une grande longévité
- Conforme aux exigences de sécurité du décret 96 333 du 10/04/1996 et à la norme EN131
- Hauteur de travail : 0,49 m
- Plateforme de travail en bois antidérapant d'une épaisseur de 9 mm
- Articulation des 2 piétements avec paliers renforcés
- Double blocage à l'ouverture par goupillage et appui des montants



Avec porte-outils

### CARACTÉRISTIQUES

- Patins antidérapants
- Marches en aluminium moulé caillebotis de 370 x 90 mm
- Avec poignée de transport pour le modèle 125 x 42 cm
- Profils aluminium épaisseur 2 mm
- Peinture époxy
- Charge utile : 150 kg



Plateforme légère, compacte et facilement transportable

ASSEMBLAGE COMPLET par tenon-mortaise et soudage assurant une grande longévité

MARCHE CAILLEBOTIS ALUMINIUM de 370 x 90 mm

Poignée de transport

DOUBLE BLOCAGE à l'ouverture par goupillage et appui des montants

HAUTEUR DE TRAVAIL : 0,49 m

PLATEAU EN BOIS ANTIDÉRAPANT DE 9 MM

CONFORME A LA NORME

**EN 131**

## PLATEFORME DE TRAVAIL ALUMINIUM

Tubes et marches aluminium.  
Charge utile : 150 kg quelque soit le modèle. Conforme EN131.



## PORTE-OUTILS

Porte-visseuse, logements pour tournevis, porte-rouleau de bande à joints ou d'adhésifs de masquage et bac à enduits amovible. Adaptable sur les 2 plateformes. Hauteur 85 cm par rapport à la plateforme.



Dim. cm	Charge utile kg	kg	Ref.	
45 x 103 x 22	50	5	500512	1

Avec porte-outils

Dim. plateforme cm	Nbre de marches y compris plateforme	Hauteur plateforme cm	Hauteur de travail maxi cm	Charge utile kg	kg	Ref.		Ref.	
125 x 42	2	49	249	150	9	500510	1	500513	1
83 x 42	2	49	249	150	7	500530	1	500533	1



## TRÉTEAU PLIANT PROFESSIONNEL

### LES PLUS

- La poutre bois permet de préserver la pièce ou le matériau posé sur le tréteau
- Charge maximum : 300 kg la paire
- Indispensable sur les chantiers.
- Transport facile



### TRÉTEAU PLIANT PROFESSIONNEL

Piètement tubulaire pliant avec embouts plastique, peinture époxy.  
Poutre bois de 80 cm.  
Avec dispositif de blocage des pieds en position ouverte et fermée.

PLAQUISTE PEINTRE MENUISIER CHARPENTIER



Largeur utile cm	Charge utile kg pour 1 paire	kg	Ref.	
80	300	3,5	113000	2

### TRÉTEAU PLIANT PROFESSIONNEL RÉGLABLE, TOUT MÉTAL

Conseillé pour le façadier.  
Réglable de 83 cm à 133 cm.  
Patins métalliques.  
La largeur utile est la largeur entre les 2 garde-corps.  
Piètement métallique pliant.

MAÇON FAÇADIER



Hauteur cm	Largeur utile cm	Charge utile kg pour 1 paire	kg	Ref.	
83 > 133	73	1000	12	113050	1
83 > 133	100	1000	14	113060	1

### TIGE MÉTALLIQUE GARDE-CORPS UNIVERSEL

S'adapte sur le tréteau réglable  
Réf. 113050, 113060 et sur le tréteau de maçon 309580, 309590 et 309600.  
Peinture époxy.  
Avec 3 supports de lisses.  
L'utilisation du garde-corps est obligatoire au-delà d'une hauteur de 50 cm.

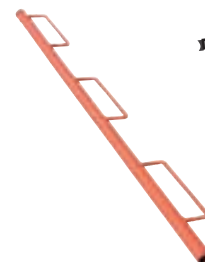

Longueur cm	kg	Ref.	
100	2,7	309610	1

## TRÉTEAU PROFESSIONNEL RÉGLABLE, POUTRE BOIS

### LES PLUS

- Réglable de 80 cm à 130 cm
- La poutre bois permet de préserver la pièce ou le matériau posé sur le tréteau
- Charge maximum : 1000 kg la paire
- Indispensable sur les chantiers
- Goupille avec ressort en acier inoxydable pour la sécurité de verrouillage
- Patins antidérapants

### CARACTÉRISTIQUES

- Peinture époxy
- Poutre bois de 75 cm
- Piètement métallique pliant
- Largeur du tréteau : 62 cm.



Transport facile

L'utilisation du garde-corps est obligatoire au-delà d'une hauteur de 50 cm !

### TRÉTEAU PROFESSIONNEL RÉGLABLE, POUTRE BOIS

Réglable de 80 cm à 130 cm.

PLAQUISTE

SPECIAL PEINTRE

MENUISIER

CHARPENTIER



Hauteur cm	Largeur utile cm	Charge utile pour 1 paire kg	kg	Ref.	📦
80 > 130	62	1000	12	113010	1

### TIGE MÉTALLIQUE GARDE-CORPS

S'adapte au tréteau réglable Réf. 113010. L'utilisation du garde-corps est obligatoire au-delà d'une hauteur de 50 cm.

Longueur cm	kg	Ref.	📦
100	2,7	113020	1



16



62



96



120



126



156



188



224



248



254



300



316



340



390



462



488



315



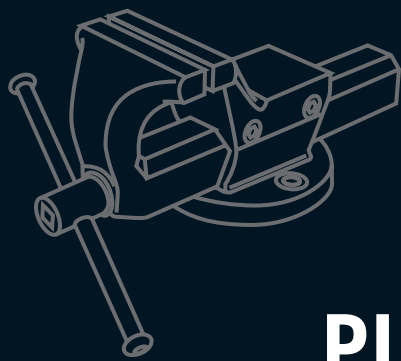

# 012

## PLOMBERIE, ÉTAUX MAINTENANCE, ÉCLAIRAGE

### PLOMBERIE

**P.318**

| CLÉS SERRE-TUBES



**P.320**

| COUPE-TUBES

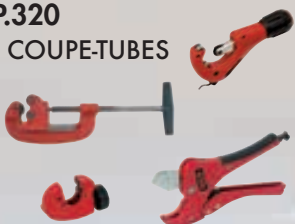

**P.322**

| OUTILS  
COMPLÉMENTAIRES  
PLOMBERIE



**P.323**

| TABLE DE  
MONTEUR



### ÉTAUX

**P.326**

| ÉTAUX MAGNAT  
ET ACCESSOIRES



**P.327**

| MORDACHES,  
ÉTAUX POUR  
MACHINES-OUTILS



### MAINTENANCE

**P.329**

| ÉCLAIRAGE



**P.333**

| OUTILS  
D'INSPECTION

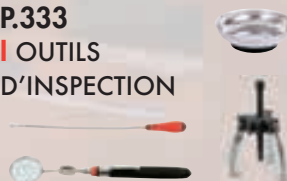

**P.334**

| PORTE-OUTILS À CLIQUET  
ET EXTRACTEURS

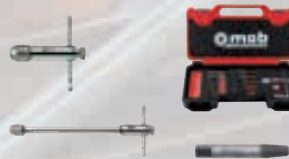

**P.338**

| PERCEUSES À MAIN





# CLÉS SERRE-TUBES



## CLÉS TUBES STILLSON

### ➤ MORS FORGÉS ET TREMPÉS

- Dureté 56 HRC = grande durée de vie.
- Précision d'approche de la molette.



### ➤ ROBUSTESSE

- Corps entièrement forgé résistant aux conditions extrêmes des chantiers.

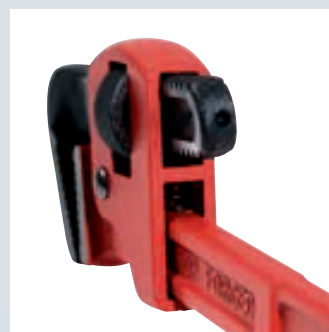

### ➤ SYSTÈME MONO-RESSORT

Plus pratique que le système 2 ressorts :

- La reprise d'effort est possible à une seule main.
- Plus efficace sur les petits diamètres.







## CLÉS STILLSON

Système mono-ressort.



L mm	L "	Ouverture max. mm	Ouverture max. "	▲ g	Ref.	☐
250	10"	34	1"	580	9021250001	1
350	14"	49	1" 1/2	1060	9021350001	1
450	18"	60	2"	1750	9021450001	1
600	24"	76	2" 1/2	2830	9021600001	1
900	36"	102	3" 1/2	5750	9021900001	1

## CLÉS U.S. FONTE

Corps en fonte : grande résistance - mors forgés et trempés (56 HRC) - système classique 2 ressorts pour un serrage type cliquet.



L mm	L "	Ouverture max. "	▲ g	Ref.	☐
250	10"	1" 1/2	660	9025250001	1
350	14"	2"	1310	9025350001	1
450	18"	2" 1/2	2130	9025450001	1
600	24"	3" 1/2	3440	9025600001	1
900	36"	5"	5530	9025900001	1

## CLÉS U.S. ALLIAGE LÉGER

Alliage léger : grande maniabilité - mors forgés et trempés (56 HRC) - système classique 2 ressorts pour un effet cliquet.



L mm	L "	S	▲ g	Ref.	☐
350	14"	2"	900	9024350001	1
450	18"	2" 1/2	1400	9024450001	1
600	24"	3" 1/2	2330	9024600001	1

## CLÉS U.S. ALLIAGE LÉGER 90°

Forme à 90° (bec de canard) pour travailler en bout dans les endroits difficiles d'accès (entre 2 tubes, sous plafond, le long des murs)



L mm	L "	S	▲ g	Ref.	☐
350	14"	2"	840	9026350001	1
450	18"	2" 1/2	1350	9026450001	1

## CLÉS SUÉDOISES EN "S"

Corps en acier forgé haute qualité traité.



L mm	Ouverture max. mm	Ouverture max. "	▲ g	Ref.	☐
340	40	1"	800	9018040001	1
430	55	1" 1/2	1380	9018020001	1
550	67	2"	2330	9018060001	1
648	103	3"	4170	9018080001	1

## CLÉS SUÉDOISES À 45°

Corps en acier forgé haute qualité traité.



L mm	Ouverture max. mm	Ouverture max. "	▲ g	Ref.	☐
340	40	1"	800	9018140001	1
430	55	1" 1/2	1380	9018120001	1
550	67	2"	2330	9018160001	1
650	103	3"	4170	9018180001	1

## CLÉ À CHAÎNE

Chaîne et corps en acier traité - tête à double denture pour un serrage et desserrage sans changer de position.



L mm	Ouverture max. mm	▲ g	Ref.	☐
300	125	750	9017300001	1

## CLÉ À SANGLE

Corps forgé - sangle interchangeable en nylon très résistant - idéale pour travaux sur pièces chromées ou polies. Capacité : 110 mm - 4" Longueur : 300 mm - 12"



L mm	Ouverture max.	A mm	B mm	C mm	D mm	▲ g	Ref.	☐
300	100mm/4"	600	30	21	45	540	9023120001	1

	L mm	A mm	B mm	▲ g	Ref.	☐
Sangle de rechange	600	600	30	30	9023000001	1

## APPAREIL À BATTRE LES COLLETS

Avec étrier - permet de former le collet sur des tubes en cuivre recuit - diamètres 6,8,10,12,16,19 mm - usage occasionnel.

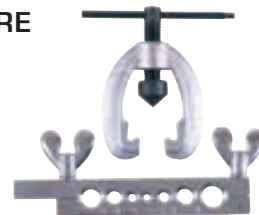

Ø mm	▲ g	Ref.	☐
6-19	950	6490061910	1



16



62



96



120



126



156



188



224



248



254



300



316



340



390



462



488



319



# COUPE-TUBES



## COUPE-TUBES TÉLESCOPIQUES

### COUPE RAPIDE ET NETTE

- Avance rapide de la molette par effet télescopique.
- 4 rouleaux à rainures pour une coupe à ras du collet.

### MODÈLE PROFESSIONNEL ROBUSTE

- Forte capacité : 3 à 42 mm.
- Pommeau confortable.
- Ebavureur rotatif escamotable.

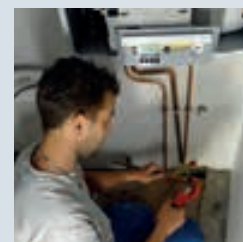

Cuivre

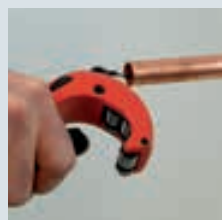

Inox

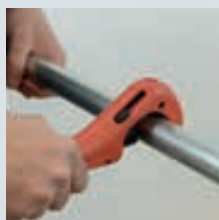

### COUPE-TUBE TÉLESCOPIQUE CUIVRE

3 à 42 mm - ébavureur - 4 rouleaux.



Ø mm	L mm	l mm	H mm	▲ g	Ref.	☐
3-42	175	29	73	620	6493034201	1
Molettes de rechange		▲ g	Ref.		☐	
6 pcs		5	6497041001		1	

### COUPE-TUBE TÉLESCOPIQUE INOX

3 à 42 mm - ébavureur - 4 rouleaux.



Ø mm	L mm	l mm	H mm	▲ g	Ref.	☐
3-42	175	29	73	620	6494034201	1
Molettes de rechange		▲ g	Ref.		☐	
6 pcs		5	6497051001		1	

### COUPE-TUBE CUIVRE

Modèle alliage léger pour tubes cuivre faible épaisseur. Capacité 3 à 30 mm. Ebavureur articulé.

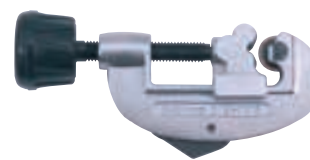

Ø mm	L mm	l mm	H mm	▲ g	Ref.	☐
3-30	143	29	60	165	6491033010	1
Molette de rechange		Ref.		☐		
1 pc		6497061001		1		

### COUPE-TUBE ACIER

Coupe précise des tubes acier ou fer. 2 rouleaux grande longueur. Acier, tige filetée avec système d'avance et de retour rapide de la coulisse - tubes de 10 à 60 mm.



Ø mm	L mm	l mm	H mm	▲ g	Ref.	☐
10-60	380	51	107	2185	6492106010	1
Molette de rechange		Ref.		☐		
1 pc		6497010001		1		



## MINI COUPE-TUBES

### UTILISATION

- Idéal en encombrement réduit et tubes parallèles

### CARACTERISTIQUES

- Avance rapide de la molette par effet télescopique
- 2 rouleaux
- Capacité : 3 à 28 mm

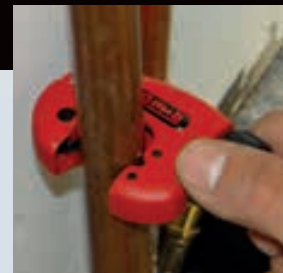

## MINI COUPE-TUBE CUIVRE

3 à 28 mm. 2 rouleaux.



Ø mm	L mm	L mm	H mm	g	Ref.	Q
3-28	78,5	18	50	220	6496003001	1
Molettes de rechange						
6 pcs		5			6497041001	1



## COUPE-TUBES PLASTIQUE

### COUPE RAPIDE

- Coupe-tubes à cliquet pour une coupe rapide et sans effort.

### COUPE NETTE

- Lame en V étudiée pour une coupe nette, sans écrasement ni bavure.
- Capacité : 3 à 42 mm.

### PRATIQUE

- Ouverture de la lame par écartement des branches.
- Nouveau grip bimatière.
- Fermeture par loquet de verrouillage.



## COUPE-TUBE PVC

3 - 42 mm.



Ø mm	L mm	l1 mm	l2 mm	E mm	g	Ref.	Q
3-42	235	50	127	20	520	6495034201	1



16



62



96



120



126



156



188



224



248



254



300



316



340



390



462



488



321



# OUTILS COMPLÉMENTAIRES



## ÉBAVUREUR TONNEAU INTÉRIEUR / EXTÉRIEUR

### UTILISATION

- Pour tous types de matériaux : cuivre, inox, aluminium, acier, PEHD.

### CAPACITÉ

- Ø 40mm.

### CARACTÉRISTIQUES

- Corps en matière métal
- Lames en acier
- Dimensions : Ø 52 mm x 57 mm
- Poids 225 g



Utilisation ébavurage intérieur



Côté ébavurage extérieur



Utilisation ébavurage extérieur



### ÉBAVUREUR TONNEAU INTÉRIEUR / EXTÉRIEUR

Ø 40 mm.



Ø mm	H mm	Ø intérieur mm	g	Ref.	📦
52	57	40	225	6498040001	1

### CLÉ DE MONTAGE ÉTAGÉE AVEC CLIQUET

Clé Ø 3/8-1/2-3/4-1". Et cliquet 1/2" femelle, manche bimatière ergonomique : polypropylène et élastomère pour le grip.



Ref.	📦
9027001201	1

### CLÉ DE MONTAGE ÉTAGÉE

Clé Ø 3/8-1/2-3/4-1".



Ref.	📦
9027010001	1

### CLIQUET 1/2" FEMELLE



Pour clé étagée. Carré d'entraînement 1/2" femelle. 30 dents. Manche bimatière. 12° angle de reprise.



L mm	Ø0 mm	H mm	g	Ref.	📦
255	38	22	420	9027720001	1



## TABLE DE MONTEUR

### LES PLUS

- Plateau de qualité élevée en multiplis, ce qui assure une grande stabilité dimensionnelle du plateau. Essence de bois : hêtre haute densité, de 25mm seulement.
- Cornière en acier, à fleur du plateau, ce qui permet la fixation simple d'étai
- Construction extrêmement robuste en tubes d'acier carrés, et appui des pieds sur le cadre, pour une résistance aux poids élevés
- Pieds évasés et emprise au sol de la dimension du plateau, pour une bonne stabilité
- Patins caoutchouc
- Maintien des pieds par goupille clips, pour un transport facilité

### CARACTÉRISTIQUES

- Dimensions : 108 x 64 cm
- Hauteur : 84 cm
- Peinture époxy couleur rouge
- Encombrement plié : 108 x 64 x 13 cm
- Tubes carrés de 35 m
- Poids : 26 kg



Plateau de qualité



Maintien des pieds pendant le transport par goupille clips.

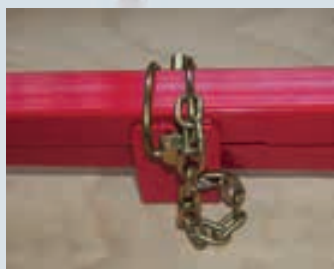

Encombrement plié : 108 x 64 x 13 cm.

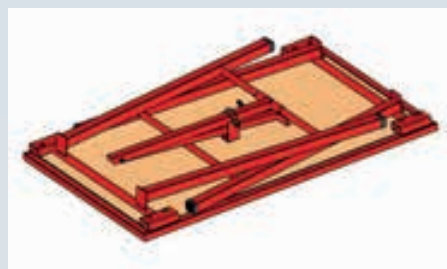

### TABLE DE MONTEUR

Plateau en bois multiplis, hêtre 25 mm.  
 Cornière en acier, à fleur.  
 Construction robuste en tubes d'acier carrés. Patins caoutchouc.  
 Maintien des pieds par goupille clips. Peinture époxy rouge.  
 Encombrement plié : 108 x 64 x 13 cm.

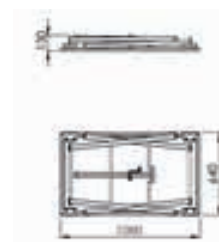

L cm	l cm	H cm	kg	Ref.	cube
108	64	84	26	9610100001	1





# LÈVE-CHARGE



## LÈVE-CHARGE

### ÉLEVATEUR MANUEL

- Charge maximale d'utilisation : 100 kg
- Hauteur maximale de pose (Sol/Plateforme) : 3.50 m
- Hauteur de chargement : 1.40 m
- Plateforme en bois multipli de 9 mm : 795 x 375 mm
- 2 sangles fournies avec l'appareil
- Système de sécurité constitué de 2 câbles :  
1 câble de travail et 1 câble de sécurité anti-chute.
- Système de freinage intégré au treuil anti-retour fixé sur la poignée de guidage.
- Bon dégagement de la manivelle pour un meilleur contrôle
- Équipé de 3 roues freinées Ø 125 mm
- Empattement : 1.05 x 1.05 x 1 m
- Poids de l'appareil : 29 kg



**Easy** CLIM



### LÈVE-CHARGE

CMU : 100 kg.  
Hauteur maximale de pose : 3.50 m.  
Hauteur de chargement : 1.40 m.  
Empattement : 1.05 x 1.05 x 1 m.



kg	Ref.	
29	6550065001	1

# PLOMBERIE C'EST AUSSI...

## FUSION BOX GARNI PLOMBERIE

>> PAGE 34

Ref.	
9477038001	1



## SLIMBAG

>> PAGE 24

Ref.	
9592000001	1



## CLÉ À MOLETTE

>> PAGE 118

Ref.	
9043201401	1



## LAMPE SLIMLED

>> PAGE 332

Ref.	
9604060001	1



## CLÉS MÂLES AIMANTÉES

>> PAGE 138

Ref.	
9061020101	1



## PINCE MULTIPRISE RAPIDE

>> PAGE 170

Ref.	
6484240401	1



## TOURNEVIS FLEXIBLES

>> PAGE 143

Ref.	
9180070001	1



## MARTEAU À GARNIR

>> PAGE 262

Ref.	
0200280301	1



## NIVOLINER

>> PAGE 240

Ref.	
6273	1



## TAPIS PROTECH

>> PAGE 498

Ref.	
6423000001	1





# ÉTAUX MAGNAT



## ÉTAUX MAGNAT

### ÉCHELLE DE MESURE

Grande enclume trempée (50-56 HRC)  
pour travaux de dressage et de refoulement.

### MORS

- Mors fraisés et trempés (52-58 HRC)  
avec dispositif des fixations de mordaches orientables  
supplémentaires (dès 120 mm).
- Glissière ajustable.
- Ouverture extra-grande.
- Dispositif de réglage.
- Pied forgé. Système MDS.



### DEUX SYSTÈMES DE SERRAGES POUR DEUX FOIS PLUS D'EFFICACITÉ

- Les étaux de la gamme Durlach, Magnat et Magnat Tube possèdent deux systèmes de serrage :
- Le système MDS exclusif qui permet d'assurer le serrage de l'étau avec un cliquet de carré 1/2". Ainsi, vous pouvez serrer aisément des pièces encombrantes et dans des positions difficiles.
  - Le serrage classique avec une poignée coulissante amovible.







## ÉTAU MAGNAT

Étau de qualité Magnat, en acier forgé, trempé, incassable. Forme ronde, ne blesse pas.

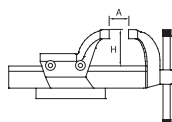
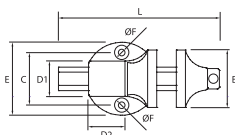

B mm	L mm	H mm	E mm	A mm	C mm	D1xD2 mm	F mm	kg	Ref.	Q
100	320	65	120	132	92	62 x 64	11,5	5,5	6469100010	1
120	365	82,5	150	146	113	75 x 75	13,5	9,6	6469120010	1
140	460	96	182	200	145	90 x 96	15	16,8	6469140010	1
160	550	117	182	205	145	110 x 122	15	24,5	6469160010	1
180	550	117	182	200	145	110 x 122	15	25	6469180010	1

## ÉTAU MAGNAT TUBE

Étau de qualité Magnat Tube. Exécution comme Magnat, mais avec mors serre-tubes soudés. Spécialement prévu pour le bâtiment.



B mm	kg	Ref.	Q
120	10	6470120010	1
140	17,2	6470140010	1
160	24,9	6470160010	1

## POIGNÉE COULISSANTE DE RECHANGE

Adaptable sur étaux Magnat et Magnat Tube.



	Pour modèle	g	Ref.	Q
Poignée	100-120	300	6465100010	1
Poignée	140	450	6465140010	1
Poignée	160-180	700	6465160010	1
Rondelle	100-120	10	6465100110	1
Rondelle	140	20	6465140110	1
Rondelle	160-180	30	6465160110	1

## DISPOSITIF DE RÉGLAGE EN HAUTEUR POUR ÉTAUX MAGNAT ET MAGNAT TUBE

Dispositif de réglage en hauteur. Réglage en hauteur en continu particulièrement facile au moyen d'un ressort à pression de gaz. Plage de réglage 240 mm. L'étau peut pivoter de 360° sans accessoires supplémentaires. Permet un travail ergonomiquement correct, particulièrement dans les écoles et les ateliers d'apprentissage.



L mm	kg	Ref.	Q
120	9,4	6468120010	1

## PLATEAU TOURNANT POUR ÉTAUX MAGNAT ET MAGNAT TUBE

Plateau tournant pour faire pivoter l'étau de 360°. Toutes les pièces sont ainsi faciles à travailler de tous les côtés.



L mm	kg	Bleu		Rouge	
		Ref.	Q	Ref.	Q
100	0,7	6471100010	1	6471110010	1
120	1,3	6471120010	1	6471130010	1
140 / 180	1,5	6471140010	1	6471150010	1

## SYSTÈME DE FIXATION RAPIDE POUR ÉTAUX MAGNAT ET MAGNAT TUBE

Vis de 100 et 120 mm permettant de changer de place et de fixer l'étau rapidement et sûrement.



L mm	kg	Ref.	Q
100	1,3	6476100010	1
120	1,3	6476120010	1

## MORDACHE DE PROTECTION ADAPTABLE SUR ÉTAU MAGNAT

Mordache de protection pivotantes en fibres synthétiques pour serrer les pièces délicates. Deux pièces nécessaires. Rabattables en position de repos pour une fonction d'étau normal.



L mm	g	Ref.	Q
140	300	6466140010	1



16  
62  
96  
120  
126  
156  
188  
224  
248  
254  
300  
316  
340  
390  
462  
488



# MORDACHES

## MORDACHE DE SERRAGE ADAPTABLE UNIQUEMENT SUR ÉTAU MAGNAT

Mordache pivotante pour assurer le serrage de tubes par fixation en trois points - une pièce nécessaire - rabattable en position de repos pour une fonction d'étau normal.



L mm	g	Ref.	☐
160	1000	6467160010	1
180	1200	6467180010	1

## ENSEMBLE DE DEUX MORDACHES UNIVERSELS À FACETTES

Adaptable sur tous types d'étaux. Fixation magnétique.



L mm	g	Ref.	☐
120	250	6479120010	1
140	300	6479140010	1
160	320	6479160010	1

## ENSEMBLE DE DEUX MORDACHES UNIVERSELS EN ALUMINIUM

Adaptable sur tous types d'étaux. Fixation magnétique.

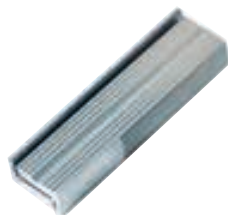

L mm	g	Ref.	☐
120	250	6464120010	1
140	300	6464140010	1
160	320	6464160010	1

## ENSEMBLE DE DEUX MORDACHES UNIVERSELS EN FIBRE DE VERRE

Adaptable sur tous types d'étaux. Fixation magnétique.



L mm	g	Ref.	☐
120	250	6475120010	1
140	300	6475140010	1
160	320	6475160010	1

## ENSEMBLE DE DEUX MORDACHES UNIVERSELS EN CAOUTCHOUC

Adaptable sur tous types d'étaux. Fixation magnétique.



L mm	g	Ref.	☐
100	200	6478100010	1
120	250	6478120010	1
140	300	6478140010	1
160	320	6478160010	1

## JEU DE 4 TYPES DE MORDACHES UNIVERSELS AIMANTÉS

Aluminium - Fibre de verre - À facettes - Caoutchouc. Adaptable sur tous types d'étaux.



L mm	g	Ref.	☐
140	950	6472140010	1

## ÉTAU À SERRE-TUBES

Étau à serre-tubes pliant. Les pièces en acier forgé garantissent la sécurité du travail. Possibilité d'ajustage grâce à des vis auto-serrantes.



Ø pouces	kg	Ref.	☐
2"	5	6474020010	1
3"	6,4	6474030010	1

## SUPPORT DE TRAVAIL

Support de travail pliant pour étaux à serre-tubes (Réf. 6474). Position de travail stable sur les chantiers. Adaptés aux étaux serre-tubes 2 et 3 pouces, avec plate-forme pour travailler en position stable.



Ø pouces	kg	Ref.	☐
2" +3"	16	6477230010	1

## ÉTAUX POUR MACHINE-OUTILS ÉQUIPÉS D'UN MDS

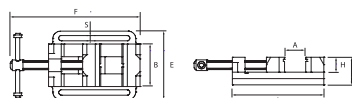

B mm	A max mm	L mm	H mm	S mm	kg	Ref.	☐
100	105	260	39	8	7,3	6473100010	1
125	125	300	48	8	10,6	6473120010	1
150	145	340	54	10	15,6	6473150010	1



## LAMPE FRONTALE

### UTILISATION

La lampe frontale permet d'évoluer dans les environnements non éclairés, et de travailler ponctuellement, en ayant les mains libres, ou lorsqu'il n'y a pas de support pour placer la lampe.

### CARACTÉRISTIQUES

- Bloc optique pivotant orientable à la verticale, pratique pour ajuster la hauteur de travail
- Piles fournies

### PERFORMANCES

- Puissance 120 lumens
- Eclairage 350 lux à 50 cm
- Etanchéité IP44
- Autonomie 12h
- 3 modes d'éclairage : normal, boost et clignotant

### CONFORT

- Serre-tête 3 bandes, pour une meilleure tenue
- Élastique souple sur les 3 bandes, pour plus de confort
- Dessus et côté ajustables, pour une adaptation au tour de tête



### LAMPE FRONTALE

3 modes d'éclairage.  
Bloc optique orientable.  
Serre tête élastique 3 bandes.  
Piles fournies.



16



62



96



120



126



156



188



224



248



254



300



316



340



390

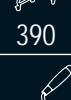

462

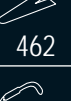

488

Nb LED	g	Ref.	
3W COB LED	105	9604010010	1



## LAMPE POCKET

### LAMPE DE POCHE

L165 mm. Format mini pour un rangement facilité.

### BOITIER

ABS pour une meilleure résistance aux chocs, à l'eau, aux graisses... IP 54.



### SYSTÈME D'ACCROCHE

- Par clip : s'accroche à la ceinture ou dans une poche
- Par aimantation : le clip magnétique permet une fixation simple et rapide

### ÉCLAIRAGE

- 6 LEDS blanches sur le côté
- 4W 100 Lux à 0,50 m.
- Autonomie 6 h.
- 3 piles AAA incluses.



### LAMPE POCKET

L165 mm. ABS. IP 54. Clip. Aimant. 6 LEDS blanches sur le côté 4W 100 Lux à 0,50 m. Autonomie 6 h. 3 piles AAA incluses.



L mm	g	Ref.	
165	55	9604050001	1

### LAMPE POUR CASQUE OU CASQUETTE

À fixer sur la visière.  
Facile à mettre et à enlever.  
Piles fournies.



g	Ref.	
40	9604030010	1

### LAMPE DE POCHE

Éclairage 2 positions : 3 ou 12 LED.  
Corps en aluminium anodisé.  
Piles fournies.



Nb LED	g	Ref.	
12	150	9604020010	1

### LAMPE MAGNÉTIQUE TÉLESCOPIQUE ET FLEXIBLE, MODELE 180

Télescopique de 18 à 56 cm.  
Flexible sur 5,5 cm.  
3 LED - 4 piles bouton LR44 incluses.  
Aimant circulaire sur la tête de la lampe.  
Aimant à l'arrière.  
Flux lumineux : 9-11 Lumens.



L mm	g	Ref.	
180 -> 560	144	9604030LED	1

### PLV 12 LAMPES MAGNÉTIQUES TÉLESCOPIQUES ET FLEXIBLES



g	Ref.	
1440	9604031201	1



## LAMPE TÉLESCOPIQUE L255

### PRATIQUE

Lampe télescopique et flexible qui permet une utilisation dans les espaces réduits

### ÉCLAIRAGE

- 72 LUX à 0.50m
- 18 LEDS blanches sur le côté
- 9 LEDS rouge sur le côté
- 3 LEDS blanche sur la tête



AIMANT CIRCULAIRE  
sur la tête  
Résistance portée : 1.5 kg

### SYSTÈME D'ACCROCHE

- Par aimantation : la base magnétique permet une fixation simple et rapide
- Les 2 mains restent libres pour travailler

3 piles AAA incluses  
4 piles bouton LR44 incluses

TÉLESCOPIQUE de 25 à 64 cm



FLEXIBLE sur 10 cm

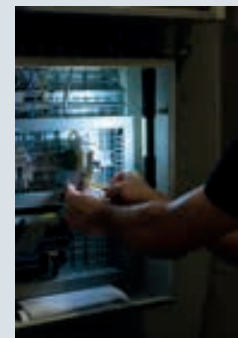
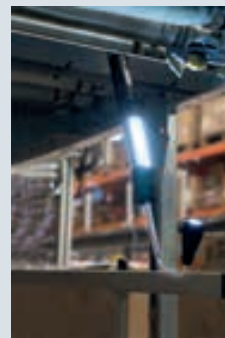
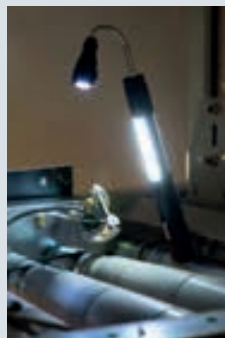
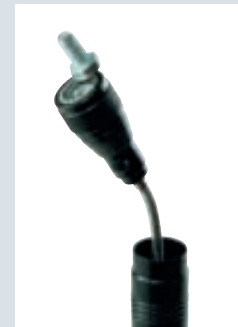

### LAMPE MAGNÉTIQUE TÉLESCOPIQUE ET FLEXIBLE, MODELE 255

L 255 mm - Télescopique de 25 à 64 cm - Flexible sur 10 cm.  
18 LEDS blanches sur le côté - 9 LEDS rouge sur le côté - 3 LEDS blanche sur la tête.  
3 piles AAA non incluses + 4 piles bouton LR44 incluses.



L mm	g	Ref.	
255 -> 640	190	960407001	1

- 16
- 62
- 96
- 120
- 126
- 156
- 188
- 224
- 248
- 254
- 300
- 316
- 340
- 390
- 462
- 488



## LAMPE BALADEUSE SLIMLED

SANS FIL- PIVOTANTE - ÉCLAIRAGE PUISSANT

SLIMLED

**BOITIER ABS** pour une meilleure résistance à l'eau, aux chocs, aux graisses...

**ULTRA PLATE**

Cette lampe présente une tête très fine (9 mm d'épaisseur) pour se glisser dans les espaces étroits et difficiles d'accès



**PUISSANCE D'ÉCLAIRAGE À LED COB**

Réglage de la puissance grâce au variateur de 300 à 700 Lux (à 0,5 m)

**CARACTÉRISTIQUES**

Autonomie : Eclairage pendant 12h en standard, 2h30 en mode maxi.  
Temps de charge : 4H. Livrée avec câble USB et chargeur secteur

**SYSTÈME D'ACCROCHE**

Tête munie d'un crochet : plus facile qu'une boucle  
Par aimantation : la base magnétique permet une fixation simple et rapide  
Les 2 mains restent libres pour travailler

**MULTI-POSITIONS**

Rotative à 360°.



### LAMPE SLIMLED

Sans fil - corps ultra-mince - luminosité constante - IP54.  
1 pied rotatif à 360° avec aimant + 1 crochet.  
Eclairage constant pendant 4h.  
Puissance réglable de 300 à 700 Lux (à 0,5 m).



L mm	g	Ref.	
375	410	9604060001	1



## DOIGT MAGNÉTIQUE FLEXIBLE

Poignée bimatière.  
Poids maximum soulevé : 3 kg  
Ø de l'aimant : 17 mm.



L mm	L flexible mm	Poids soulevé	Ø mm	g	Ref.	☐
500	400	3 kg	17	160	9601300001	1

## DOIGT MAGNÉTIQUE TÉLESCOPIQUE

Longueur : 13 à 65 cm.  
Poids maximum soulevé : 700 g.  
Aimant : 7 mm.



L mm	Poids soulevé	Ø mm	g	Ref.	☐
130 -> 650	700 g	7	21	9601070001	1

## MIROIR TÉLESCOPIQUE

Orientable. Diamètre du miroir : 30 mm.  
Clip ceinture – manchon PVC expansé



L mm	Ø mm	g	Ref.	☐
170 -> 480	30	50	9602300001	1

## PLATEAU MAGNÉTIQUE

Ø 110 mm – acier inoxydable.  
Utilisable à 180°.  
Base caoutchoutée non marquante.



Ø mm	g	Ref.	☐
110	161	9600110001	1



## ARRACHE-ROULEMENTS INTEX23

### UTILISATION

Pour des configurations variées d'extraction en mécanique :  
extraction intérieure ou extérieure, 3 griffes ou 2 griffes.

### CARACTÉRISTIQUES

- Montage des griffes sans outil ni pièce détachée.
- Griffes autobloquantes : mise en place à 1 main.
- Prise extérieure ou intérieure : griffes réversibles.
- 3 griffes transformable en 2 griffes.

### RAPIDE

- Inversion facile des griffes en 15 secondes.
- Changement 3 griffes vers 2 griffes en 5 secondes.



## JEU DE 2 EXTRACTEURS INTEX23

- 1 extracteur 2 tonnes.
- 1 extracteur 5 tonnes.



Contenu		g		Ref.				☐	
2 t + 5 t		1690		0770000101				1	
Puissance tonne	Ø mm	CE Capacit. EXT min	CE Capacit. EXT max	CI Capacit. INT min	CI Capacit. INT max	P mm	g		
2 t	13	9,2	20	80	47	70	65	435	
5 t	17	13,3	20	120	55	120	100	1390	





# PORTE-OUTILS À CLIQUET



## PORTE-OUTILS À CLIQUET

### UTILISATION

- Pratique pour tarauder dans les endroits difficiles d'accès à la place d'un tourne-à-gauche classique.

### MANDRIN NOVATEUR : POUR LE SERRAGE COMBINÉ CARRÉ ET HEXAGONAL

- Utilisable avec des extracteurs de vis cassées.
- Utilisable avec des embouts 1/4.

### CARACTÉRISTIQUES

- Porte-outils à cliquet, 3 positions : fixe, serrage, desserrage.
- Broche amovible, s'utilise en T ou en L.
- Mandrin de serrage à deux mors.



Présentation sur carte



Broche amovible

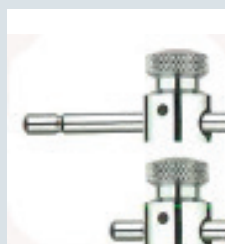

3 positions





# PORTE-OUTILS À CLIQUET



## PORTE-OUTILS À CLIQUET



**Achat en 2012 par le groupe Mob**  
Début 2012, la société Peddinghaus a racheté l'activité outils à main de l'entreprise Schröder de Wuppertal. Le porte-outil fait partie du savoir-faire historique de la société, made in Germany et reconnu dans le monde entier.

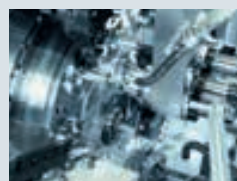

### Parmi les équipements de Schröder

Tours automatiques monobroches à cames et commande CNC jusqu'à Ø 65 mm

Tours automatiques à six broches à cames et commande CNC jusqu'à Ø 32 mm

Fraisage / Brochage / Polygonage / Engrènement / Laminage / Rectification sans centre / Extrusion à froid / Double pression jusqu'aux presses 5 postes avec jusqu'à 16 mm de diamètre de fil selon la norme DIN EN ISO 9001 et VDA 6.1 certifiées par le centre de contrôle technique de Ronsdorf-Wuppertal / CPS avec système CAQ / Tri par caméra entièrement automatique pour la garantie 100 % d'une livraison à zéro défaut.

### PORTE-OUTILS À CLIQUET 2-5

2-5 M3-8 ISO M1-6 85 mm.

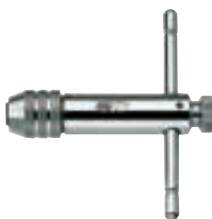

L mm	l mm	DIN	ISO	Ø1 mm	Ø2 mm	g	Ref.	☐
85	2,0-5,0	M3-8	M1-6	25	22	200	40061	1

### PORTE OUTILS À CLIQUET 4,6-8

4,6-8 M5-12 ISO M6-12 110.



L mm	l mm	DIN	ISO	g	Ref.	☐
110	4,6-8,0	M5-12	M6-12	330	40071	1

### PORTE-OUTILS À CLIQUET LONG 4,6-8

Ouverture 4,6-8.  
DIN : M5-12.  
ISO : M6-12 - 300mm.



L mm	g	Ref.	☐
300	440	40091	1

### PORTE OUTILS À CLIQUET LONG 9-12,5

Ouverture 2-5 mm. DIN : M3-8.  
ISO : M1-6 250 mm.

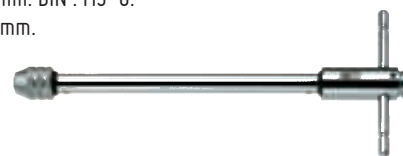

L mm	g	Ref.	☐
250	265	40081	1

### PORTE OUTILS À CLIQUET BIG 9-12,5

Ouverture 9-12,5mm -  
M13-20



L mm	g	Ref.	☐
117	330	40034	1

- 16
- 62
- 96
- 120
- 126
- 156
- 188
- 224
- 248
- 254
- 300
- 316
- 340
- 390
- 462
- 488
- 335



# EXTRACTEURS DE VIS CASSÉES



## EXTRACTEUR DE VIS CASSÉES

### UTILISATION

Pour vis et goujons cassés, noyés, sans prise.

Utilisé après perçage de la vis, avec une clé, un porte-outils à cliquet ou un tourne à gauche.

### QUALITÉ

Version Hi-Trac : usinage supplémentaire pour une meilleure performance d'extraction.

Brevet EU 01125106.3-2302



# EXTRACTEURS DE VIS CASSÉES



## EXTRACTEURS HÉLICOÏDAUX HI-TRAC



Taille	Pour vis	Ø mm	Foret	L mm	Carré mm	▲ g	Ref.	☐
1	M4	1,8	6	50	2,6	3	45110	1
2	M6-8	3	7	55	3,7	6	45120	1
3	M8-10	4	9	60	4,8	13	45130	1
4	M12-14	6	1	65	7	26	45140	1
5	M14-20	8	14	70	9	43	45150	1
6	M20-24	12		77	12	85	45160	1

## BOX SMALL EXTRACTEURS DE VIS CASSÉES



Contenu

- 4 extracteurs :
- N°1: M4 - N°2 : M6 à M8 -
- N°3 : M8 à M10 - N°4 : M12 à M14.
- 1 porte-outils à cliquet.
- 2 têtes amovibles à cliquet :
- Capacité M3 - M8 - M5 - M12.
- 1 rallonge.
- 1 broche amovible pour une utilisation en T ou L.
- Calage mousse bicolore.



Contenu	Dim mm	▲ g	Ref.	☐
8 pces	135x215x60	900	9416009001	1

## JEUX D'EXTRACTEURS HI-TRAC

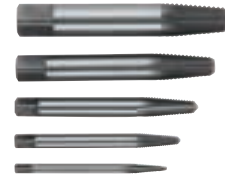

Contenu	Tailles	Pour vis	Dim mm	▲ g	Ref.	☐
5 pces	1-2-3-4-5	M4-20	95x55x15	130	46151	1
6 pces	1-2-3-4-5-6	M4-24	100x70x20	230	46161	1

## BOX EXTRACTION M4-M20



- 1 porte-outils à cliquet - 1 tête amovible.
- 5 forets coniques.
- 5 extracteurs : N°1: M4/ N°2 : M6 à M8/
- N°3 : M8 à M10/ N°4 : M12 à M14 // N°5 : M14 à M20.
- 7 tarauds : M4-M5-M6-M8-M10-M12-M16



Contenu	Dim mm	▲ g	Ref.	☐
19 pces	405x225x60	1650	9436019001	1



## MODE D'EMPLOI EXTRACTEURS

1- marquer le centre avec pointe et marteau



2- percer au centre du gougeon cassé, idéalement avec un foret conique adapté



3- placer l'extracteur sur tourne à gauche, ou mieux, un porte-outils à cliquet



4- extraire





# EXTRACTEURS DE VIS CASSÉES



## EMBOUS EXTRACTEURS DE VIS ABIMÉES

### POUR VIS ENDOMMAGÉES

- Les extracteurs permettent d'ôter les vis dont l'empreinte est trop abîmée pour être dévissée par un tournevis ou un embout.
- L'empreinte peut être tellement « usinée » qu'elle est méconnaissable. Fonctionne sur les empreintes ex-Torx, Tamper Torx, PH, PZ, fente, hexagonales, carrées...

### 3 DIMENSIONS

- 1<sup>ère</sup> dimension pour têtes de vis de Ø 5 à 6 mm environ
- 2<sup>ème</sup> pour têtes de vis de Ø 6 à 8 mm
- 3<sup>ème</sup> pour têtes de vis de Ø 8 à 10 mm

### PRINCIPE

- L'embout « mord » dans ce qui reste d'empreinte.
- Embout revêtu Titane (dureté bien supérieure aux vis) - grande durabilité.
- Embout 50 mm, 1/4 à gorge, C6,3, adaptable sur toute visseuse.



### 3 EXTRACTEURS DE VIS ABÎMÉES



	g	Ref.	
3 pcs	100	9190001001	1

### PRÉSENTOIR DE 8 JEUX DE 3 EXTRACTEURS DE VIS ABÎMÉES



Ref.	
9190008001	1

### PERCEUSE À MAIN, PETITE TAILLE

Sur commande.



Ø mm	Ø roue mm	L mm	g	Ref.	
6 (1/4)	64	235	280	50024	1

### PERCEUSE À MAIN, GRANDE TAILLE

1 pignon.  
Sur commande.



Ø mm	Ø roue mm	L mm	g	Ref.	
8 (5/16)	83	295	515	50114	1

# MAINTENANCE C'EST AUSSI...

## VALISE 128 PIÈCES

>> PAGE 46

Ref.	
9538128001	1



## BOX 1/4"

>> PAGE 73

Ref.	
9416046001	1



## TAPIS PROTECH

>> PAGE 498

Ref.	
6423000001	1



## PINCE À RIVETER

>> PAGE 182

Ref.	
9350001001	1



## PINCE À DÉCOFFRER 600 MM

>> PAGE 296

Ref.	
7181600001	1



## BROSSE À BOUGIE

>> PAGE 511

Ref.	
863240	1



## LUNETTES

>> PAGE 502

Ref.	
801891	1



## RIVOIR PROTECT

>> PAGE 259

Ref.	
0001409301	1



## MESURE

>> PAGE 235

Ref.	
6275051401	1



## NIVEAU

>> PAGE 240

Ref.	
6251400010	1





# 013



## GROS ŒUVRE

### TERRASSIER

P.342

| PELLES, PIOCHES



P.345

| RÂTEAUX, RACLOIRS, GRATTOIRS



P.348

| LIEURS ET LIENS



### MAÇON FAÇADIER

P.350

| SEAUX ET AUGES



P.355

| TAMIS, BACS À CIMENT



P.357

| OUTILS À BÂTIR



P.363

| TALOCHES

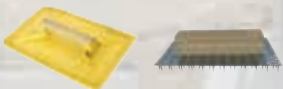

P.366

| OUTILS DE FACADIER / I.T.E.

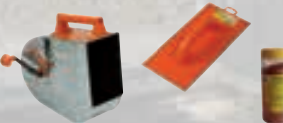

### DALLAGISTE

P.378

| LISSEUSES, BARRES À DÉBULLER

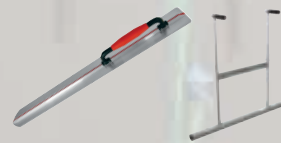

P.384

| CHEMIN DE FER, FER À MARCHÉ



### CONSTRUCTION BOIS

P.386

| ÉTAIS



P.387

| POSE-LAME, TIRE-MURS



P.388

| CALES





## PELLE DE TERRASSIER

### UTILISATION

- Déplacer sable, gravier, terre...



### QUALITÉ D'ACIER

- Tôle d'épaisseur constante 2mm +/- 0.2mm
- Traitement thermique aux 2/3 :  
dureté de 45-50HRC des zones travaillantes et dureté  
moindre près de la douille pour éviter tout risque de casse.



### GÉOMÉTRIE

- Étudiée pour un bon équilibre en main (ne tourne pas)
- Bon galbe (pelle pas trop plate)
- Nouvel angle de douille.

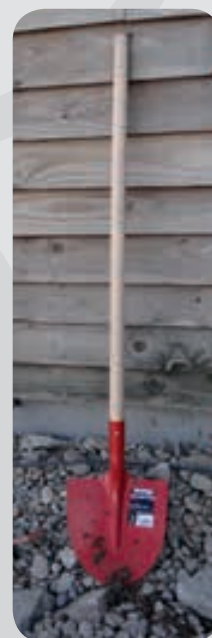

## PELLE DE TERRASSIER RONDE

Qualité professionnelle.  
Bout pointu pour une  
meilleure pénétration.



Sans manche				110 cm		
l cm	g	Ref.	☐	Ref.	☐	☐
25	1050	6380250010	1			
27	1100	6380270010	5	6380270201	69260	5
29	1150	6380290010	5	6380290201	69260	5

## PELLE DE TERRASSIER CARRÉE

Angle d'attaque droit,  
idéal pour les tranchées  
et les caniveaux ou contre  
un mur.



Sans manche				110 cm		
l cm	g	Ref.	☐	Ref.	☐	☐
23	1200	6381230010	5			
25	1300	6381250010	5	6381250201	69260	5
27	1450	6381270010	5	6381270201	69260	5





## PELLE BORDEAUX

Angle d'attaque droit, rebords latéraux.



Sans manche				110 cm		
l cm	g	Ref.	☐	Ref.	✎	☐
23	1000	6383230010	1	6383230201	69260	1

## PELLE À NEIGE OU À GRAIN ALU

Alliage aluminium-magnésium.  
Épaisseur constante 2mm (+/- 0,2mm).  
Double sertissage.

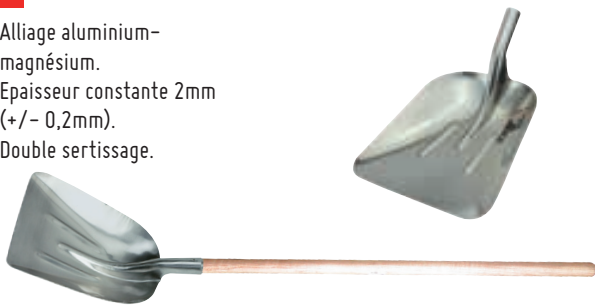

Sans manche				Bois				
l cm	L mm	e mm	g	Ref.	☐	Ref.	✎	☐
33	36	2	950	6382360010	1	6382360201	69250	1
36	42	2,5	1000	6382420010	1	6382420201	69260	1

## PELLE À NEIGE OU À GRAIN PLASTIQUE

Plastique résistant PEHD (Polyéthylène Haute Densité).  
Lame acier sur le rebord. Emmanchement par vis zinguée.



Frêne 110 cm				
l cm	g	Ref.	✎	☐
36	1800	6388360201	69260	1

## MANCHES POUR PELLE



	L mm	ø mm	Bois		Nerfibre	
			Ref.	☐	Ref.	☐
Pour pelles et racloirs	1100	38,5	6926000001	1	6958000801	1
Pour pelle à neige 638236	1200	40	6925000001	1		
Pour pelles racloirs griffes	1300	38,5	6926130001	1		
Pour pelles	1300 cintré	38,5	6927130001	1		

## PELLE MICRO



### COMPACITÉ

- Pour tous les usages où le manche peut gêner : vider des sacs, remplir la bétonnière, travailler en hauteur ou en espace restreint...
- Tient dans un véhicule : sert de pelle d'appoint.

### QUALITÉ

- Âme en fibre de verre
- Poignée bi-matière confortable
- Rebords pour ne pas abimer les chaussures.



## PELLE MICRO MULTI FONCTION

Compacte.  
Manche bi-matière.  
Âme en fibre de verre.



L mm	L1 mm	L2 mm	P mm	g	Ref.	☐
700	150	125	220	1150	0114010020	1



16



62



96



120



126



156



188



224



248



254



300



316



340



390



462



488



343



## PIOCHE DE TERRASSIER

### UTILISATION

- Travaux de voirie et de terrassement
- Côté panne pour creuser et côté pic pour attaquer.

### QUALITÉ D'ACIER

- Acier à forte teneur en carbone C45
- Zone de trempage des parties travaillantes : dureté de 40-48HrC sur 50 mm

### MANCHE

Choix de 2 manches :

- Manche Nerotech : tri-matière, armé de fibre de verre, incassable.
- Manche bois : plus léger.

### QUALITÉ DE FINITION

- Produit entièrement poli avant peinture
- Peinture au trempé



Manche tri-matière

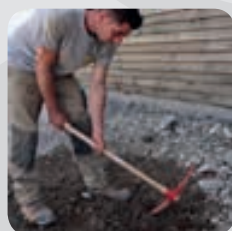
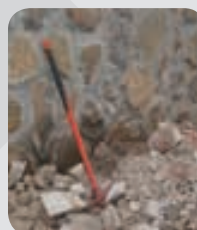

Manche bois



## PIOCHE DE TERRASSIER

Acier C45.  
Pointes trempées.

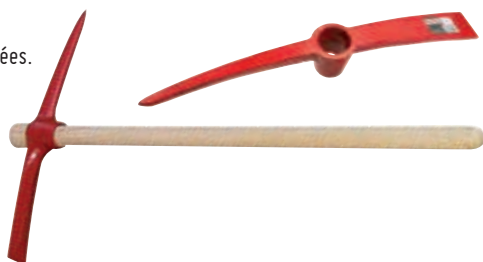

kg	L cm	Sans manche		Bois		Nerotech	
		Ref.	☐	Ref.	✂ ☐	Ref.	✂ ☐
2	55	6384200010	1	6384200201	6911 5	6384200701	6955 1
2,5	55	6384250010	1	6384250201	6911 5	6384250701	6955 1
3	60	6384300010	1				

## PIOCHE DE CANTONNIER

Panne large pour couper les racines, désherber, creuser des sols meubles.



kg	L cm	Sans manche		Bois	
		Ref.	☐	Ref.	✂ ☐
1,5	43	6387150010	1	6387150201	6911 5
2	47	6387200010	1		

## MANCHE DE PIOCHE NERTECH

Oeil rond. Manche Nerotech trimatière, armé de fibre de verre, surmoulé polypropylène et élastomère, de forme légèrement ovale, de section 29x41 côté préhension et 48 mm côté tête.



L mm	A mm	g	Ref.	☐
920	48	1025	6955000701	1

## MANCHE DE PIOCHE MANCHE BOIS

Oeil rond. Manche de section 35 côté préhension et 50 mm côté tête.



L mm	A mm	g	Ref.	☐
1000	50	880	6911000001	1



## BIG MUTT

### GRATTOIR GRANDE TAILLE

- Outil en acier forgé 230x180 mm
- Lame épaisse biseautée et réaffûtable
- Manche en bois dur longueur 1380 mm de gros diamètre

### EXEMPLES D'UTILISATION

- Gratter les cuves
- Gratter le sol
- Décaper
- Enlever des marquages
- Couper des racines sur le chantier
- Enlever mousses et végétaux
- Décoller des carreaux
- Briser la glace...



### GRATTOIR MULTI-USAGE BIG MUTT



Forgé, très résistant  
livré emmanché



		Frêne 130 cm	
L mm	g	Ref.	☐
1650	2500	0114010000	1

### GRATTOIR À COFFRAGE



Lame acier extra-dure soudée. Epaisseur 1 mm.  
Excellente durée de vie.  
Référence Mondelin.



				Emmanché manche bois L 110 mm	
l cm	Ref.	☐	✂	Ref.	☐
30	301350	1	6359	301351	3

### GRATTOIR À COFFRAGE

Lame acier bleuie extra-dure soudée  
Epaisseur 0,9 mm



l cm	Ref.	✂	☐
30	6361000010	6359	1

### GRATTOIR À COFFRAGE LAME VISSÉE

Lame acier extra-dure boulonnée. Epaisseur 1 mm.  
Référence Mondelin.



l cm	Ref.	✂	☐
30	301310	6359	6
10	301410	6359	1

### GRATTOIR À COFFRAGE LAME VISSÉE

Lame acier bleuie extra-dure vissée  
Epaisseur 1 mm



l cm	Ref.	✂	☐
30	6357000001	6359	1

### MANCHE GRATTOIR À COFFRAGE



l cm	g	Ref.	☐
110	700	6359000001	1



16



62



96



120



126



156



188



224



248



254



300



316



340



390



462



488



345



# RÂTEAUX ET RACLOIRS

## RÂTEAU

Dents trempées.



Denture	⚖ g	Sans manche		Frêne 150 cm		
		Ref.	📦	Ref.	📏	📦
14	705	6450140010	1	6450140201	6941	5
16	770	6450160010	1	6450160201	6941	5

## RÂTEAU À ASPHALTE ET BÉTON

Dents trempées. Réglette en acier sur le dessus pour niveler.



Denture	L mm	⚖ g	Ref.	📏	📦
16	460	770	6450161010	6941	1

## RÂTEAU À GOUDRON

Pour niveller, ratisser, épandre l'enrobé.

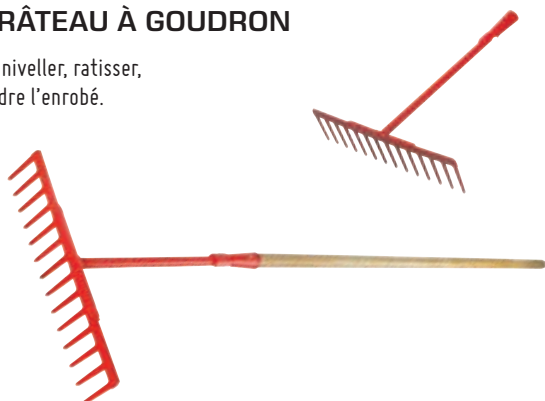

L cm	⚖ g	Sans manche		Frêne		
		Ref.	📦	Ref.	📏	📦
40	1400	6452000010	1	6452000201	6941	5

## RACLOIR RABOT À BOUE



L cm	⚖ g	Ref.	📏	📦
35	1080	6455000010	69261	1

## GRIFFE À REMBLAI

Pour déplacer le remblai, déchausser les pierres.



L cm	⚖ g	Ref.	📏	📦
24,5	1200	6451000010	69261	1

## RACLOIR À BITUME

### GAMME

- Lame acier pour enrobés lourds 0/14. Lame pliée en acier trempé.
- Lame alu pour enrobés lourds 0/14 (routes). Lame en aluminium, plus légère.
- Lame bois pour enrobés légers 0/6 : pistes cyclables, trottoirs... Douille métallique boulonnée. Biseautée sur une face.



## RACLOIR À BITUME

Lame pliée en acier trempé. Pour enrobés lourds 0/14.

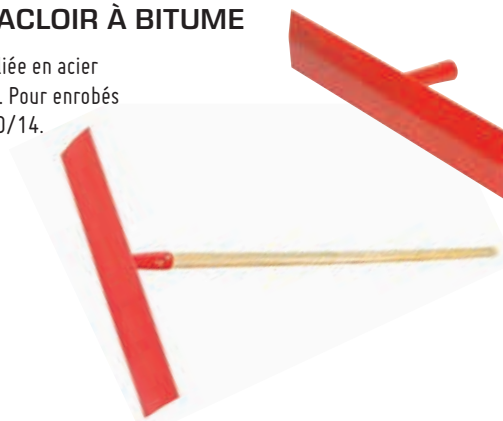

L cm	H cm	Angle	⚖ g	Sans manche		Frêne		
				Ref.	📦	Ref.	📏	📦
48	9,8	165°	1035	6453000010	1	6453000201	6941	5



## RACLOIR À BITUME EN HÊTRE

Douille métallique boulonnée. Biseautée sur une face. Pour enrobés légers 0/6.



L cm	H cm	Ref.		
50	11	6456000001	6941	1

## RACLOIR À BITUME ALU

Lame en aluminium, plus légère. Utilisable sur enrobés lourds 0/14 (routes).



L cm	H cm	Angle	Ref.		
48	9,8	165°	6457000001	6941	1

## MANCHE RATEAUX ET RACLOIRS

Manche frêne.



L cm	∅ mm		Ref.	
150	28	700	6941150001	5

## ÉPANDEUR À BÉTON

Crochet pour relever le treillis avant de couler le béton.



L cm	H cm	Angle		Ancienne Ref. Mondelin	Ref.		
50	9,2	140°	980	302800	6155000001	6156 + 6359	1

## MANCHE ACIER ÉPANDEUR

Tube acier.



L cm		Ancienne Ref. Mondelin	Ref.		
145	1420	302810	6156000001	6156	1

## DAMES

### CARACTÉRISTIQUES

- Pour damer les sols.
- En fonte
- Manche hêtre.

### GAMME

- Dame carrée : la plus fréquemment utilisée. Pratique également autour de poteaux béton.
- Dame ronde : pour damer autour d'obstacles non rectilignes (poteaux ronds, lampadaires)
- Dame rectangulaire : plus grande surface et poids supérieur.



## DAME DE MAÇON CARRÉE

En fonte avec manche bois. Pour damer les sols.



Dimensions mm		Ancienne Ref. Mondelin	Ref.	
150 x 150	5	303200	0144150201	1

## DAME DE MAÇON RONDE

En fonte avec manche bois. Pour damer autour d'obstacles (poteaux, lampadaires).



∅ mm		Ancienne Ref. Mondelin	Ref.	
150	5	303220	0144151201	1

## DAME DE MAÇON RECTANGULAIRE

En fonte avec manche bois. Plus grande surface et poids supérieur.



Dimensions mm		Ancienne Ref. Mondelin	Ref.	
180 x 150	8	303210	0144180201	1



16



62



96



120



126



156



188



224



248



254



300



316



340



390



462



488



## LIEUR AUTOMATIQUE



### ULTRA-RAPIDE

- Sert à lier très rapidement les ferrillages pour béton armé
- Utile également pour ligaturer les sacs et clôtures.

Vidéo :



## LIEUR AUTOMATIQUE

Pour pose de liens à boucle. Cliquet rapide.



L cm	g	Ancienne Ref. Mondelin	Ref.	
31	420	302340	6541001001	1

## LIENS À BOUCLE

Botte de liens recuits en acier  $\varnothing$  1,1 mm



Nombre de liens	L mm	$\varnothing$ mm	g	Ancienne Ref. Mondelin	Ref.	
1000	120	1,1	1200	302350	6540120101	1
5000	120	1,1	6000	302360	6540120501	1
1000	140	1,1	1250	302370	6540140101	1
5000	140	1,1	6250	302390	6540140501	1
1000	160	1,1	1300	302380	6540160101	1

## BOBINOT DE FIL

Fil d'acier recuit. Pour ligaturer les grilles, les treillis...  
96 bobinots dans un seau.



L m	$\varnothing$ mm	g	Ancienne Ref. Mondelin	Ref.	
env.17	1,4	200	302330	6540200001	96

## CALE À BÉTON

### UTILISATION

- Permet de maintenir les armatures dans la position souhaitée lors de la mise en œuvre du béton.
- Facile d'utilisation. Permet une bonne tenue des fers pour un parfait enrobage.
- Sachet de 100 cales.



## CALE À BÉTON

Maintien des armatures. Sachet de 100 cales.

	Enrobage en mm	Diamètre maxi en mm	Ancienne Ref. Mondelin	Ref.
x 100	25	12	303410	6542251001
x 100	30	14	303420	6542301001



# TERRASSIER C'EST AUSSI...

## MASSE

>> PAGE 275



Ref.	
0136410701	1

## GRIFFE À CINTRER

>> PAGE 289



Ref.	
0183100601	1

## BALAI TP

>> PAGE 512



Ref.	
863030	1

## BARRE À MINE 1.75 M

>> PAGE 299



Ref.	
0152170001	1

## RÈGLE NIVEAU

>> PAGE 241



Ref.	
351620	1

## COUPE-BOULONS CLASSIQUE

>> PAGE 178



L mm	Ref.	
750	0515080610	1

## ODOMÈTRE

>> PAGE 238



Ref.	
878000	1

## TENAILLE RUSSE HAUTE QUALITÉ

>> PAGE 177



L mm	Ref.	
250	6350250001	1

## PULVÉRISATEUR

>> PAGE 505



Ref.	
853090	1

## PROTECTION POUR FER À BÉTON

>> PAGE 361



Ref.	
303450	1

## TRACE

>> PAGE 244



Ref.	
6264500201	1

## SCIE À BÛCHE

>> PAGE 194



Ref.	
6301000001	1

## SEAU PLASTIQUE

### + LES PLUS

- Economique
- Léger
- Pratique



Poignée plastique monobloc pour un meilleur confort de travail



Moule des seaux



Test qualité seaux



Atelier de plasturgie



### SEAU DE MAÇON PLASTIQUE 11L

Polyéthylène noir.



Capacité L	∅ anse mm	Ref.	∅
11	5,3	341080	10
11	6,3	341000	10

### SEAU DE MAÇON PLASTIQUE ANSE 6,8 ROUGE

Polyéthylène. Anse gros diamètre pour plus de confort.



Capacité L	∅ anse mm	Ref.	∅
11	6,8	341070	10

### SEAU DE MAÇON PLASTIQUE 11L ROUGE

Polyéthylène rouge.



Capacité L	∅ anse mm	Ref.	∅
11	5,3	341060	10
11	6,3	341010	10

### SEAU DE MAÇON PLASTIQUE AVEC POIGNÉE

Polyéthylène noir. Poignée plastique monobloc pour un meilleur confort de travail.



Capacité L	Couleur	∅ anse mm	Ref.	∅
11	noir	5,3	341081	10

### SEAU DE MAÇON PLASTIQUE ANSE 6,8

Polyéthylène noir. Anse gros diamètre pour plus de confort.



Capacité L	∅ anse mm	Ref.	∅
11	6,8	341020	10

### SEAU DE 16 LITRES AVEC POIGNÉE

Seau de carreleur ou seau à veau.



Capacité L	Couleur	∅ anse mm	Poignée plastique	Ref.	∅
14	noir	6,3	non	341040	10
16	noir	6,3	non	341030	10
16	noir	5,3	oui	341031	10
16	rouge	5,3	oui	341032	10



## SEAU PROCHOK®

### + LES PLUS

- Longévité accrue
- Plus souple
- Plus épais
- Résistant aux variations extrêmes de température
- Excellente résistance aux chocs et à l'abrasion
- Haute qualité

**PROchok®**



### ANSE

- Diamètre de l'anse au choix : 6,8 mm - 6,3 mm ou poignée plastique anse 5,3 mm

### CARACTÉRISTIQUES

- En matière caoutchoutée noire.
- Gradués.



Transfert sur la plateforme logistique



### SEAU DE MAÇON PROCHOK®

Gradué.  
En matière caoutchoutée noire.



Capacité L	Ø anse mm	g	Ref.	📦
12	6,8	906	341120	10
12	6,3	880	341140	10

### SEAU DE MAÇON ECOCHOK

En matière caoutchoutée noire. Gradués.



Capacité L	Ø anse mm	g	Ref.	📦
11	6,3	650	341130	10

### SEAU DE MAÇON PROCHOK® AVEC POIGNÉE

Gradué.  
En matière caoutchoutée noire.



Capacité L	Ø anse mm	g	Ref.	📦
12	5,3	890	341141	10

### SEAU DE MAÇON CAOUTCHOUC

Gradué.  
En caoutchouc vulcanisé.



Capacité L	Ø anse mm	kg	Ref.	📦
12	7	2,3	341100	5



16



62



96



120



126



156



188



224



248



254



300



316



340



390



462



488



351

## AUGE DE MAÇON PLASTIQUE



### AUGE PLASTIQUE

- Economique
- Légère
- Pratique

### CARACTÉRISTIQUES

- Matière : polyéthylène.



Matière plastique pour la fabrication

Presse à injecter : fabrication de nos auges plastique et PROCHOK



### AUGE MAÇON PLASTIQUE 10L

Polyéthylène noir.



Capacité L	Dim. mm	Ref.	📦
10	440 x 340 x 110	342100	10

### AUGE MAÇON PLASTIQUE 25L

Polyéthylène noir.



Capacité L	Dim. mm	Ref.	📦
25	620 x 430 x 155	342250	10

### AUGE MAÇON PLASTIQUE 13L

Polyéthylène noir.



Capacité L	Dim. mm	Ref.	📦
13	410 x 340 x 170	342130	10

### AUGE MAÇON PLASTIQUE 35L

Polyéthylène noir.



Capacité L	Dim. mm	Ref.	📦
35	720 x 500 x 200	342350	10

## AUGE PROCHOK®



### + LES PLUS

- Excellente prise en main
- Bords renforcés
- Résistance aux variations extrêmes de température.
- Longévité accrue.
- Excellente résistance aux chocs et à l'abrasion
- Haute qualité

## PROchok®



343530 - 35 litres



343510 - 12 litres



343520 - 25 litres



Atelier de plasturgie



## AUGE DE MAÇON PROCHOK®

En matière caoutchoutée.



Capacité L	Dim. mm	g	Ref.	☐
12	465 x 355 x 120	900	343510	5
25	625 x 450 x 160	1700	343520	5
35	715 x 490 x 160	2200	343530	5

## AUGE DE MAÇON CAOUTCHOUC

En caoutchouc vulcanisé



Capacité L	Dim. mm	Ref.	☐
10	460 x 310 x 135	343100	5
20	590 x 410 x 150	343200	5
30	630 x 440 x 150	343300	5
40	690 x 500 x 185	343400	5



16



62



96



120



126



156



188



224



248



254



300



316



340



390



462



488



533



533



533



533



533

## AUGE CABAS

PROchok®

### + LES PLUS

- Très résistant
- Bonne prise en main pour un transport facile grâce aux 2 poignées.

### UTILISATION

- Pour le transport sur les chantiers de ciment, gravier, terre, déblai...

### CARACTÉRISTIQUES

- En matière caoutchoutée noire
- Forme cabas



### AUGE CABAS PROCHOK®

Forme cabas. En caoutchouc souple. En matière caoutchoutée noire.



Capacité L	kg	Ref.	📦
26	1	343440	1
40	1,580	343450	1

### AUGE CABAS PLASTIQUE

Forme cabas. En plastique. Polyéthylène noir.



Capacité L	kg	Ref.	📦
26	0,960	342440	1
40	1,480	342450	1

## TAMIS SUPERCHOK



### + LES PLUS

- Excellente résistance aux chocs : en polystyrène choc
- Toile en acier galvanisé
- Excellente tension de la toile : soudure continue sur toute la base du tamis
- Haute qualité

### PRATIQUE

- Faible encombrement
- Facilité d'empilement avec système anti-blocage

### CARACTÉRISTIQUES

- Ø 45 cm
- Profondeur : 10 cm
- Polystyrène choc.



Dimensions des mailles	Ø fil mm	Ø trou mm
Toile n° 4	0,80	6,30
Toile n° 6	0,63	4,00
Toile n° 8	0,45	3,00
Toile n° 10	0,45	2,20
Toile n° 12	0,40	1,90
Toile n° 14	0,40	1,60
Toile n° 16	0,32	1,40
Toile n° 18	0,28	1,25



Contrôle qualité



Hauteur de 5 tamis empilés : 35 cm



### TAMIS PLASTIQUE SUPERCHOK

Usage professionnel. Très grande résistance aux chocs.



Dimensions	Ref.	☐
Toile n° 4	301840	1
Toile n° 6	301860	1
Toile n° 8	301880	1
Toile n° 10	301900	1
Toile n° 12	301920	1
Toile n° 14	301940	1
Toile n° 16	301960	1
Toile n° 18	301980	1

### TAMIS PLASTIQUE SUPERCHOK AVEC CROISILLON

Usage professionnel. Très grande résistance aux chocs.



Dimensions	Ref.	☐
Toile n° 4 avec croisillon	301740	1
Toile n° 6 avec croisillon	301750	1
Toile n° 8 avec croisillon	301760	1
Toile n° 10 avec croisillon	301770	1
Toile n° 12 avec croisillon	301780	1
Toile n° 14 avec croisillon	301790	1
Toile n° 16 avec croisillon	301800	1
Toile n° 18 avec croisillon	301810	1

### TAMIS DE MAÇON BOIS

Usage professionnel. Ø 45 cm. Profondeur 10 cm. De la maille la plus large n°4 à la plus fine n°14.

Dimensions	Ref.	☐
Toile n° 4	302040	1
Toile n° 6	302060	1
Toile n° 8	302080	1
Toile n° 10	302100	1
Toile n° 12	302120	1
Toile n° 14	302140	1



16



62



96



120



126



156



188



224



248



254



300



316



340



390



462



488



355

## BACS À CIMENT

### PASSAGES DE ROUES

- Versions 3 entrées : avec décrochement pour passage des roues de la bétonnière et encoche pour passage des roues de la brouette.

### TROIS GAMMES

#### Gamme Super Pro

- Forte épaisseur
- Polyéthylène haute densité
- Excellente tenue et durabilité

#### Gamme Pro

- Epaisseur intermédiaire (5 mm)
- Polyéthylène haute densité
- Bonne tenue et durabilité

#### Gamme Bâtiment

- Plus léger
- Economique



### BAC À CIMENT RECTANGULAIRE SUPER PRO

Forte épaisseur. Polyéthylène haute densité. Avec décrochement pour passage des roues de la bétonnière et encoche pour passage des roues de la brouette. 1,50 m x 2 m. Profondeur du bac : 10 cm.



Dimensions m	Profondeur du bac cm	Epaisseur mm	kg	Ref.	
1,5 x 2	10	7	20	344010	1

### BAC À CIMENT RECTANGULAIRE PRO

Epaisseur intermédiaire. Polyéthylène. Avec décrochement pour passage des roues de la bétonnière et encoche pour passage des roues de la brouette. 1,50 m x 2 m. Profondeur du bac : 10 cm.



Dimensions m	Profondeur du bac cm	Epaisseur mm	kg	Ref.	
1,5 x 2	10	5	17	344030	1

### BAC À CIMENT CIRCULAIRE SUPER PRO

Forte épaisseur. Polyéthylène haute densité. Ø : 1,50 m. Profondeur du bac : 10 cm.



Ø m	Profondeur du bac cm	Epaisseur mm	kg	Ref.	
1,5	10	7	12	344000	1

### BAC À CIMENT CIRCULAIRE PRO

Epaisseur intermédiaire. Polyéthylène. Ø : 1,50 m. Profondeur du bac : 10 cm.



Ø m	Profondeur du bac cm	Epaisseur mm	kg	Ref.	
1,5	10	5	13	344020	1

### BAC À CIMENT RECTANGULAIRE SÉRIE BÂTIMENT

Epaisseur plus faible. 3 entrées. 2 m x 1,35 m. Poids : 9,7 kg. Profondeur du bac : 9 cm.



Dimensions m	Profondeur du bac cm	Epaisseur mm	kg	Ref.	
2 x 1,35	9	3,5	9,7	344060	1

### BAC À CIMENT CARRÉ SÉRIE BÂTIMENT

Epaisseur plus faible. Pour mélanger de plus petit volumes. 1 m x 1 m



Couleur	Dimensions m	Profondeur du bac cm	Epaisseur mm	kg	Ref.	
Noir	1 x 1	4,1	3,1	3,7	344050	1
Rouge	1 x 1	4,1	3,1	3,7	344040	1

## TRÉTEAU MÉTALLIQUE DE MAÇON PIÉTEMENT FIXE



### + LES PLUS

- Idéal pour les travaux de construction en hauteur
- Réglable en hauteur de 1,20 à 2,20 m ou de 1,00 à 1,85 m selon modèle
- Longueur de poutre : 1,10 m
- Résistance : 1 500 kg la paire (charge uniformément répartie)

### CARACTÉRISTIQUES

- Stabilité au sol
- Robuste
- Porte-outils adaptable sur le tréteau de maçon pour améliorer l'ergonomie du poste de travail : 309580 + 309620.

Existe en version pied pivotant : facile à ranger

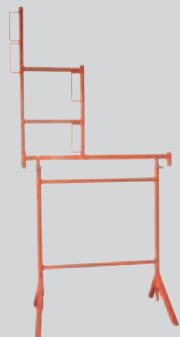

*L'utilisation d'un garde-corps est obligatoire au-delà d'une hauteur de 50 cm.*

309580  
+ 309620

### PORTE-OUTILS MÉTALLIQUE UNIVERSEL

Adaptable sur le tréteau de maçon réf. 309580, 309590, 30.9600, 113050 et 113060. 4 supports de lisses.  
Résistance : 500 kg la paire (charge uniformément répartie).



kg	Ref.	kg
5,5	309620	1

### TRÉTEAU MÉTALLIQUE DE MAÇON, PIVOTANT

Faible encombrement grâce à ses pieds pivotants. Ø 42 mm. Longueur poutre : 1,10 m. Résistance : 1500 kg la paire (charge uniformément répartie).



Hauteur réglable m	kg	Ref.	kg
1,25 > 2,21	22	309600	1

### TRÉTEAU MÉTALLIQUE DE MAÇON, FIXE

Ø 42 mm. Longueur poutre : 1,10 m - Résistance : 1500 kg la paire (charge uniformément répartie). Possibilité d'adapter un porte-outils.



Hauteur réglable m	kg	Ref.	kg
1,20 > 2,20	22	309580	1
1,00 > 1,85	16	309590	1

### TIGE MÉTALLIQUE GARDE-CORPS UNIVERSEL

Adaptable sur le tréteau de maçon réf. 309580, 309590, 309600, 113050 et 113060. 3 supports de lisses.

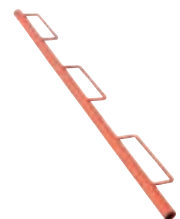

kg	Ref.	kg
2,7	309610	1



16



62



96



120



126



156



188



224



248



254



300



316



340



390



462



488



357

## POSE-BORDURES

TMS



### + LES PLUS

- Réduit l'effort : équipé de 2 poignées ergonomiques démontables qui permettent :
  - une flexion réduite et une meilleure aisance de travail
  - le transport et la pose aisés des bordures
  - un rangement et une manipulation plus faciles
- Système auto-bloquant et anti-dévers
- Châssis robuste en acier, finition époxy, pour une durée de vie plus importante
- Sur le pose-bordure réglable, possibilité de travailler avec une pelle mécanique grâce au crochet central de suspension
- Prise en main confortable grâce à 2 poignées en élastomère
- Facile d'utilisation



### UTILISATION

- Facilite la manutention et la pose des bordures de trottoirs.

### POSE-BORDURES RÉGLABLE

- Réglable de 0,50 m à 1 m, tous les 10 cm.



### POSE-BORDURES RÉGLABLE ET DÉMONTABLE

Avec crochet central de suspension. Acier, finition peinture époxy. Pour bordures de 0,50 m à 1 m. Réglable de 0,50 m à 1 m, tous les 10 cm. Charge maximum : 150 kg.



### POSE BORDURES DÉMONTABLE

Acier, finition peinture époxy. Pour bordures standards de 1 m. Charge maximum : 120 kg.



kg	Ref.	📦
15	303110	1

kg	Ref.	📦
9	303100	1



## POTEAU D'ANGLE

### + LES PLUS

- Pour la construction des murs en parpaings, briques ou autres matériaux
- Supprime l'utilisation du fil à plomb et le réglage du cordeau à chaque rangée de moellons ou briques
- Permet de réaliser des angles variables et supérieurs à 90°, intérieurs et extérieurs
- Support de cordeau et de niveaux intégrés au poteau

#### CARACTÉRISTIQUES

- Composé d'un poteau avec 2 haubans réglables. Le poteau et les haubans sont respectivement équipés d'une platine pour la fixation. Les haubans servent de maintien à la mise en oeuvre du poteau.
- Une pièce coulissante sur le poteau intègre 2 niveaux ainsi qu'un système de réglage d'angle. Elle permet au maçon d'amener le système définissant l'angle à la hauteur supérieure du rang maçonné pour obtenir, grâce au cordeau horizontal, le niveau supérieur du rang à construire.
- Haubans et pièce coulissante en peinture époxy.
- Poteau galvanisé. Livré sans cordeau. Emballé dans un fourreau de protection.



Pièce coulissante avec support de cordeau, de niveaux et système de réglage d'angle

Platine de fixation du poteau

Platine de fixation du hauban



## POTEAU D'ANGLE



L m	kg	Ref.	📦
3	16	309650	1

## ETRIER DE COFFRAGE SÉRIE PRO

#### UTILISATION

- Permet la réalisation de coffrage, linteau, dessus de mur, longrine, de largeur 200 mm.
- S'utilise avec des planches de coffrage d'épaisseur 27 mm.



## ETRIER DE COFFRAGE SÉRIE PRO

Tube carré de 35 mm. Assemblage boulonné. Référence Mondelin.

Ref.	📦
309500	10



## ETRIER DE COFFRAGE SÉRIE ÉCO

Tube carré de 30 mm. Assemblage par sertissage. Référence Mondelin.

Ref.	📦
309510	10



## COINS À BÂTIR

#### UTILISATION

- Pour la construction de vos murs en briques et en parpaings avec angle à 90°. Permet d'assurer l'alignement des briques et des parpaings de façon simple, rapide et pratique.
- Livré avec un cordeau de 60 m. Possibilité de régler l'aplomb grâce aux deux points d'accrochage du coin à bâtir.
- Utilisation préconisée d'un plomb de Ø 50 mm.



## COINS À BÂTIR

Permet d'assurer l'alignement des briques et parpaings. Lot de 4.



x 4	Ref.	📦
x 4	309670	1



16



62



96



120



126



156



188



224



248



254



300



316



340



390



462



488

## ENTONNOIR À BANCHE



### UTILISATION

- Pour couler le béton proprement entre les banches ou entre les planches de coffrage.

### AVANTAGE

- L'entonnoir permet de guider le béton et d'éviter tous débordements :
  - béton non gaspillé
  - chantier propre

### PRATIQUE

- Les rebords servent de poignée pour déplacer l'entonnoir facilement.
- 2 écartements possibles selon la position : 200mm ou 300mm.



Banette largeur 200 mm



Banette largeur 300 mm

## ENTONNOIR À BANCHE

Pour aider au remplissage des blocs à bancher



Dim.	Ref.	
530 x 800 x 275	344100	1

## APPAREIL À DÉCOFFRER



### UTILISATION

- Permet de descendre facilement et en toute sécurité les planches de coffrage en hauteur
- Pour tous types de panneaux de coffrage
- Montage et démontage facile

### CARACTÉRISTIQUES

- Charge maxi. 75 kg
- Treuil anti-retour
- Empattement des bras : 1,52 m.
- Double-câble, breveté : système de sécurité constitué d'1 câble de travail et d'1 câble de sécurité anti-chute
- Système de freinage intégré au treuil anti-retour fixé sur la poignée de guidage, qui permet une grande maniabilité de l'appareil
- Support de treuil plus ergonomique et pratique pour un transport facile
- Empattement des pieds : 1,15 x 1,15 x 1,10 m permettant une grande stabilité
- 3 roues de Ø 125 mm dont 2 équipées d'un système de blocage du pivot et du roulage. Passage dans une porte de 0,73 m sans replier le piètement.



## APPAREIL À DÉCOFFRER

Aide au décoffrage plafond.



kg	Ref.	
37	309910	1

## PROTECTIONS POUR FERS À BÉTON

### UTILISATION

- Modèle universel. Pour fers de  $\varnothing$  8 à 32 mm
- Diamètre également adapté à la protection de l'extrémité d'un serre-joint

### CARACTÉRISTIQUES

- Polypropylène orange.



## PROTECTIONS POUR FER À BÉTON

Pour fers de  $\varnothing$  8 à 32 mm.



	Ref.	
Sac de 100 pièces	303450	1
Sac de 25 pièces avec système de suspension	303451	1

## RÉSERVATION POUR PIED DE GARDE-CORPS

### + LE PLUS

- Utilisation facile et rapide en raison du sens de pose et de perforation universel.

### UTILISATION

- Pour garde-corps de  $\varnothing$  42 mm
- A utiliser sur les dalles, les balcons...

### CARACTÉRISTIQUES

- En polyéthylène.



Perforation très aisée de l'opercule de la réservation



## RÉSERVATION POUR PIED DE GARDE-CORPS

A utiliser sur les dalles, les balcons... En polyéthylène. Pour garde-corps de  $\varnothing$  42 mm.



	Ref.	
Sac de 100 pièces	303460	1
Sac de 25 pièces	303461	1



16



62



96



120



126



156



188



224



248



254



300



316



340



390



462



488



361

## LES POSES COLLÉES

### ROULEAUX APPLICATEURS DE COLLE



#### + LES PLUS

- Le dégagement : poignée suffisamment haute pour que l'utilisateur n'ait pas la main en contact avec le mortier colle
- La prise en main : poignée en tube rond cintré
- Le gain de temps : le rouleau dépose juste ce qu'il faut de colle.



#### CARACTÉRISTIQUES

- Produit assemblé par soudure robotisée
- Finition électro-zinguée.

Existe également pour bloc de pierre ponce



Pour la réalisation des joints de mortier lors de la pose des blocs pierre ponce

152710 : Platoir pour la finition des joints des parpaings



Pour le collage des briques Monomur

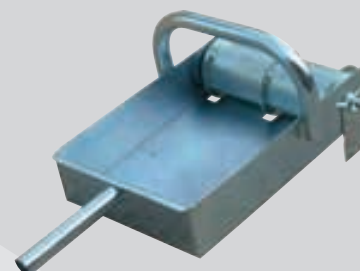

Pour le collage des blocs béton rectifiés

#### ROULEAU APPLICATEUR DE COLLE BRIQUES MONOMUR

Pour le collage des briques Monomur.



l cm	Ref.	📦
20	361010	1
30	361020	1
37,5	361030	1

#### ROULEAU APPLICATEUR DE COLLE POUR BLOCS BÉTON RECTIFIÉS

Pour le collage des blocs béton rectifiés.



l cm	Ref.	📦
20	361110	1

#### GRILLE DE POSE POUR LES BLOCS PIERRE PONCE

Pour joints de mortier lors de la pose des blocs pierre ponce.

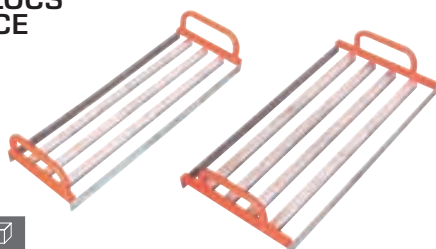

l cm	Ref.	📦
20	362200	1
30	362300	1

#### PLATINES ARASEMENT POUR CONSTRUCTION COLLÉE

##### UTILISATION

- Outil indispensable pour la réalisation de l'arase périphérique de mortier lors de la pose de la première rangée, dans le cas de construction collée.



#### PAIRE DE PLATINES ARASEMENT, CONSTRUCTION COLLÉE

Pour la réalisation d'une arase parfaite en bord de dalle.



	Ref.	📦
x2	361200	1

## TALOCHE



Fabrication des taloches ABS jaune



### + LES PLUS

- PRO ABS JAUNE**
- L'ABS assure une meilleure résistance aux chocs et à l'abrasion
  - Pour usage intensif
  - Excellente qualité
  - Excellente résistance à l'abrasion



- Plateaux
  - Rectangulaires
  - Pointus
- Poignées
  - Bois
  - Plastique



Taloch PRO ABS jaune pour usage intensif, excellente qualité, excellente résistance à l'abrasion

Taloch SUPERCHOK en polystyrène, très haute résistance

Taloch PS choc gris En polystyrène haute résistance

Taloch PS noire issue de la filière recyclage

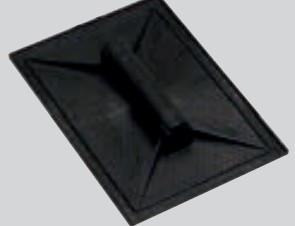
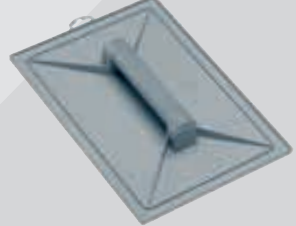
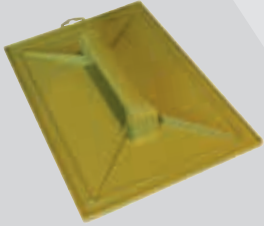

### TALOCHE PRO ABS JAUNE, RECTANGULAIRE, POIGNÉE BOIS

Dim. cm	Ref.	
28 x 41	311300	6
26 x 35	311310	6
18 x 27	311320	6
14 x 44	311370	6



### TALOCHE PRO ABS JAUNE, POINTUE, POIGNÉE BOIS

Dim. cm	Ref.	
18 x 27	311332	6



### TALOCHE PRO ABS JAUNE, POINTUE, POIGNÉE PLASTIQUE

Dim. cm	Ref.	
14 x 8	311352	6

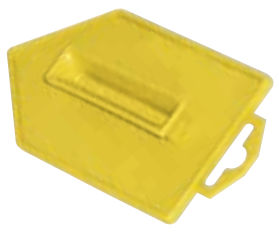

## TALOCHE POINTUES



### UTILISATION

- Spécial angle et accès difficiles, pour des finitions parfaites.
- Taloches pro ABS jaune pour usage intensif, excellente qualité, excellente résistance à l'abrasion.

### ■ Poignées

- Bois
- Plastique



Taloches PRO ABS jaune pour usage intensif, excellente qualité, excellente résistance à l'abrasion

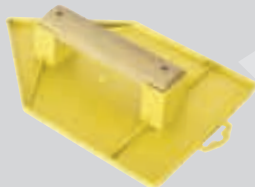

Taloches SUPERCHOK en polystyrène, très haute résistance



Taloches PS choc grise en polystyrène haute résistance

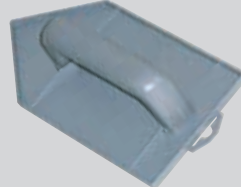

Taloches PS noire issue de la filière recyclage



### TALOCHE SUPERCHOK RECTANGULAIRE, POIGNÉE BOIS



Dim. cm	Ref.	📦
28 x 41	311100	6
26 x 35	311110	6
18 x 27	311120	6
14 x 44	311170	6

### TALOCHE SUPERCHOK POINTUE, POIGNÉE BOIS



Dim. cm	Ref.	📦
18 x 27	311132	6

### TALOCHE SUPERCHOK RECTANGULAIRE, POIGNÉE PLASTIQUE

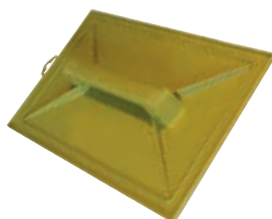

Dim. cm	Ref.	📦
28 x 41	311000	6
26 x 35	311010	6
18 x 27	311020	6

### TALOCHE SUPERCHOK POINTUE, POIGNÉE PLASTIQUE

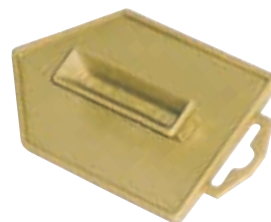

Dim. cm	Ref.	📦
18 x 27	311032	6
14 x 27	311042	6
14 x 8	311052	6



## TALOCHE PS CHOC GRISE RECTANGULAIRE, POIGNEE BOIS



Dim. cm	Ref.	📦
28 x 41	312100	6
26 x 35	312110	6
18 x 27	312120	6
14 x 44	312170	6

## TALOCHE NOIRE PLASTIQUE RECTANGULAIRE, POIGNEE BOIS



Dim. cm	Ref.	📦
28 x 41	313100	6
26 x 35	313110	6
18 x 27	313120	6
14 x 44	313170	6

## TALOCHE PS CHOC GRISE POINTUE, POIGNEE BOIS



Dim. cm	Ref.	📦
18 x 27	312132	6

## TALOCHE NOIRE PLASTIQUE POINTUE, POIGNEE BOIS



Dim. cm	Ref.	📦
18 x 27	313132	6

## TALOCHE PS CHOC GRISE RECTANGULAIRE, POIGNEE PLASTIQUE

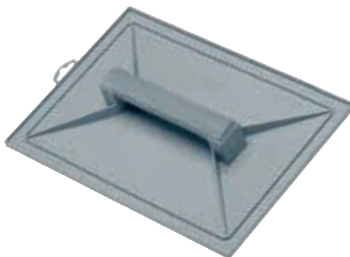

Dim. cm	Ref.	📦
28 x 41	312000	6
26 x 35	312010	6
18 x 27	312020	6

## TALOCHE NOIRE PLASTIQUE RECTANGULAIRE, POIGNEE PLASTIQUE



Dim. cm	Ref.	📦
28 x 41	313000	6
26 x 35	313010	6
18 x 27	313020	6

## TALOCHE PS CHOC GRISE POINTUE, POIGNEE PLASTIQUE

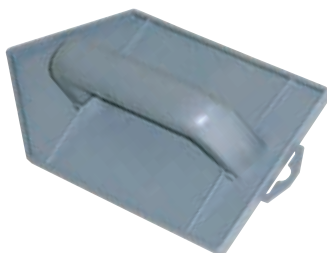

Dim. cm	Ref.	📦
18 x 27	312032	6
14 x 27	312042	6
14 x 8	312052	6

## TALOCHE NOIRE PLASTIQUE POINTUE, POIGNEE PLASTIQUE



Dim. cm	Ref.	📦
18 x 27	313032	6
14 x 27	313042	6
14 x 8	313052	6



16



62



96



120



126



156



188



224



248



254



300



316



340



390



462



488



965

## TALOCHE BOIS SEMELLE MOUSSE



### + LES PLUS

- Montage traditionnel par double queue d'aronde
- Excellente qualité du bois, garantie sans voilage, bords chanfreinés et finition poncée
- Longévité
- Outil indispensable

### UTILISATION

- Pour une finition traditionnelle des crépis

### CARACTÉRISTIQUES

- Poignée ovale ergonomique ou poignée carrée pour une très bonne prise en main
- Semelle mousse polyuréthane jaune

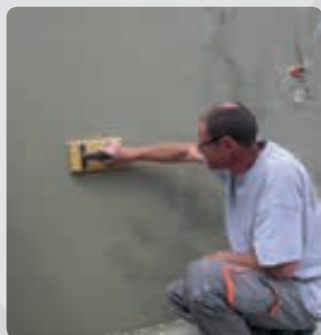

### TALOCHE BOIS, SEMELLE MOUSSE, POIGNÉE OVALE

Pour une finition traditionnelle des crépis.  
Montage traditionnel par double queue d'aronde.  
Semelle mousse polyuréthane jaune, poignée ovale ergonomique.

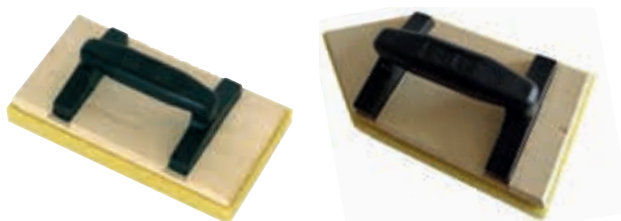

Dim. cm	Plateau	Ref.	☐
18 x 33	rectangulaire	314157	6
14 x 25	rectangulaire	314167	6
13 x 20	rectangulaire	314177	6
14 x 27	pointu	314187	6

### TALOCHE BOIS, SEMELLE MOUSSE, POIGNÉE CARRÉE

Pour une finition traditionnelle des crépis.  
Montage traditionnel par double queue d'aronde.  
Semelle mousse polyuréthane jaune,  
poignée carrée ergonomique.

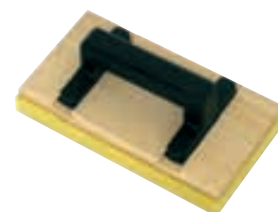

Dim. cm	Plateau	Ref.	☐
18 x 33	rectangulaire	315157	6
14 x 25	rectangulaire	315167	6
13 x 20	rectangulaire	315177	6
14 x 27	pointu	315187	6





## PLATEAU DE RECHANGE POUR TALOCHE MOUSSE

Mousse polyuréthane finition traditionnelle.



Dim. cm	Plateau	Ref.	📦
18 x 33	rectangulaire	314357	1
14 x 25	rectangulaire	314367	1
13 x 20	rectangulaire	314377	1
14 x 27	pointu	314387	1

## TALOCHE MONOBLOC MOUSSE POLYURÉTHANE JAUNE

Pour une finition traditionnelle des crépis.



Dim. cm	Ref.	📦
14 x 25	314567	6

## TALOCHE POINTUE MONOBLOC MOUSSE POLYURÉTHANE JAUNE

Pour une finition traditionnelle des crépis.



Dim. cm	Ref.	📦
14 x 27	314587	6

## TALOCHE BOIS, SEMELLE MOUSSE, SPECIALE FAÇADIER

Pour une finition fine des enduits : semelle mousse à petites alvéoles. Poignée ovale.

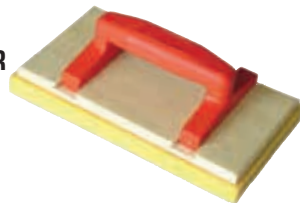

**FAÇADIER**

Dim. cm	Ref.	📦
14 x 25	321360	6

## PLATEAU DE RECHANGE POUR TALOCHE BOIS 321360

Mousse à petites alvéoles.



Dim. cm	Ref.	📦
14 x 25	321390	1

## TALOCHE SEMELLE MOUSSE MONOBLOC ORANGE

Pour une finition fine des enduits : semelle mousse à petites alvéoles. Plateau et poignée monobloc en polystyrène choc.

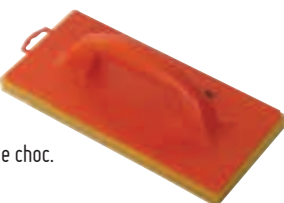

**FAÇADIER**

Dim. cm	Ref.	📦
14 x 25	321310	1
14 x 29	321320	1
17 x 34	321330	1

## TALOCHE BOIS



### CARACTÉRISTIQUES

- Plateau en bois de 1ère qualité garanti sans voilage finition poncée et bords chanfreinés
- Poignée ergonomique monobloc ovale en polypropylène
- Poignée assemblée par double queue d'aronde

Fabrication atelier bois



## TALOCHE BOIS POIGNÉE OVALE ERGONOMIQUE

Poignée monobloc assemblée sur le plateau par double queue d'aronde.

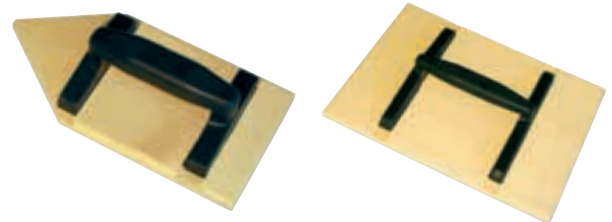

Dim. cm	Ref.	📦
30 x 40 rectangulaire	314000	6
26 x 40 rectangulaire	314010	6
26 x 33 rectangulaire	314020	6
18 x 33 rectangulaire	314050	6
14 x 27 rectangulaire	314060	6
18 x 33 pointu	314102	6
14 x 27 pointu	314112	6
7 x 16 pointu (poignée bois)	314122	1

## PLATEAU DE RECHANGE POUR TALOCHE BOIS

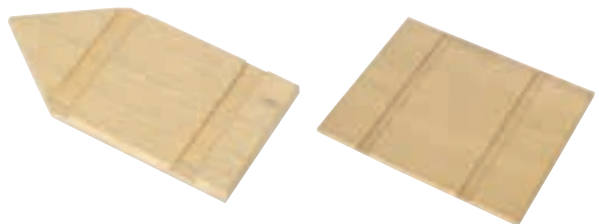

Dim. cm	Ref.	📦
30 x 40 rectangulaire	314200	1
26 x 40 rectangulaire	314210	1
26 x 33 rectangulaire	314220	1
18 x 33 rectangulaire	314250	1
14 x 27 rectangulaire	314260	1
13 x 20 rectangulaire	314270	1
18 x 33 pointu	314302	1
14 x 27 pointu	314312	1



16



62



96



120



126



156



188



224



248



254



300



316



340



390



462



488



# KIT FINITION FAÇADE

## KIT FINITION FAÇADE



### + LES PLUS

- Pour le nettoyage des outils de finition lors de la réalisation des façades
- Kit d'essorage composé de 2 rouleaux amovibles pour faciliter le nettoyage
- Système anti-vagues qui évite à l'eau de déborder lors des déplacements du kit
- Grille amovible pour un nettoyage facile

NOUVEAU

### COMPOSITION

- Bac plastique rouge 17 L
- Grille amovible
- 2 rouleaux amovibles
- Taloche bois 14 x 25 cm  
semelle mousse polyuréthane jaune
- Taloche bois 14 x 27 cm pointue  
semelle mousse polyuréthane jaune
- 1 plateau de rechange 14 x 25 cm

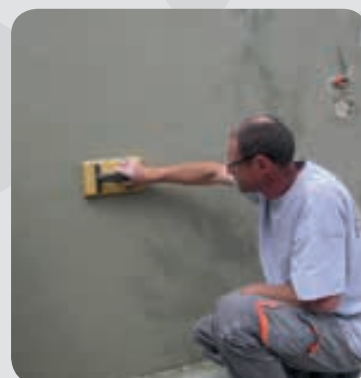

## KIT FINITION FAÇADE



Ref.

314600



1



## TALOCHE-GRATTON



Nouvelle conception avec renforts



### UTILISATION

- Pour réalisation d'enduits avec finition grattée
- En intérieur ou extérieur.

### CARACTÉRISTIQUES

- Connecteur interchangeable en tôle emboutie
- Poignée bois
- Haute qualité



Fabrication

## TALOCHE-GRATTON

Connecteur interchangeable en tôle emboutie. Poignée bois.



Dim. cm	Nb pointes	Dim. pointes mm	Ref.	☐	Connecteur de rechange	☐
14 x 24	240	15	321200	6	321201	10
15 x 25	480	8	321210	6	321211	10
15 x 7	132	8	321250	6	sans connecteur de rechange	

## TALOCHE-GRATTON ESPAGNOLE POIGNÉE BOIS

Connecteur interchangeable en tôle emboutie.



Dim. cm	Nb pointes	Dim. pointes mm	Ref.	☐	Connecteur de rechange	☐
14 x 24	240	15	321230	6	321201	10
15 x 25	480	8	321240	6	321211	10

## TALOCHE-GRATTON ESPAGNOLE POIGNÉE PLASTIQUE

Connecteur interchangeable en tôle emboutie.

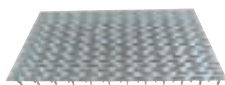

Dim. cm	Nb pointes	Dim. pointes mm	Ref.	☐	Connecteur de rechange	☐
14 x 24	240	15	321270	6	321201	10
15 x 25	480	8	321260	6	321211	10

## TALOCHE-GRATTON AMOVIBLE

### UTILISATION

- Pour réalisation d'enduits avec finition grattée
- En intérieur ou extérieur.



### CARACTÉRISTIQUES

- Connecteur amovible vissé
- Poignée et monture ergonomiques en plastique



### 2 DIMENSIONS

- 1 dimension classique avec 1 connecteur vissé sur la monture
- 1 grande dimension avec 2 connecteurs vissés sur le plateau ajouré



Vue de dessous

## TALOCHE-GRATTON AMOVIBLE

Poignée et monture ergonomiques. Connecteur amovible.



Dim. cm	Nb pointes	Dim. pointes mm	Ref.	☐	Connecteur de rechange	☐
14 x 25	480	8	321220	6	321221	10
15 x 25	180	15	321190	6	321191	10

## TALOCHE GRATTON AMOVIBLE GRANDE DIMENSION

2 connecteurs vissés sur le plateau plastique ajouré.



Dim. cm	Nb pointes	Dim. pointes mm	Ref.	☐	Connecteur de rechange	☐
29 x 25	960	8	321110	4	321221 (x2)	10
30 x 25	360	15	321100	4	321101 (x2)	10

## TALOCHE À POINTES

Pointes trempées. Pour crépis hydrauliques. Longueur des pointes : 18 mm.



Dim. cm	Nb pointes	Poignée	Ref.	☐
33 x 24	181	Bois	321000	2
18 x 26	100	Bois	321010	2
18 x 9	76	Sangle	321020	6
18 x 9	76	Plastique	321030	6



16



62



96



120



126



156



188



224



248



254



300



316



340



390



462



488



369

## TALOCHE ABRASIVE

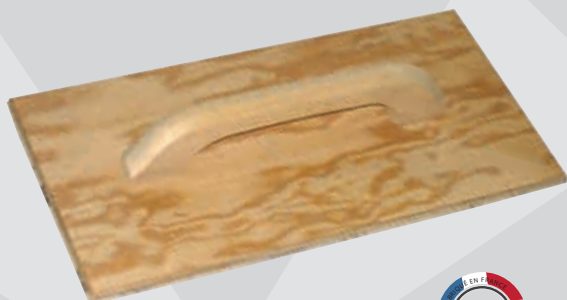

### UTILISATION

- Pour dresser le polystyrène et le béton cellulaire
- Permet de réaliser des effets

### CARACTÉRISTIQUES

- Poignée et monture bois
- Grain de 16



## TALOCHE ABRASIVE

Poignée et monture bois. Grain de 16. Pour dresser le polystyrène et le béton cellulaire. Permet de réaliser des effets.



Dim. cm	Ref.	☐
16,5 x 25	322020	1
20 x 35	322010	1
25 x 50	322000	1

## PAPIER ABRASIF DE RECHANGE

Grain de 16.



Dim. cm	Ref.	☐
16,5 x 25	322120	1
20 x 35	322110	1
25 x 50	322100	1

## SCIOTTE LAMES DENTÉES

Lames dentées avec 2 lames longitudinales.



Longueur cm	Largeur mm	Ref.	☐
30	10	301510	10
30	20	301520	10

## SCIOTTE LAMES LISSES

Lames lisses sans lame longitudinale.



Longueur cm	Largeur mm	Ref.	☐
30	10	301610	10
30	20	301620	10

## GRATTON-PEIGNE MANCHE BOIS

Denture pas de 3.



Dim. cm	Ref.	☐
16	321300	1

## BRIQUE CARBORUNDUM

Pour grésér les enduits spéciaux, imitation pierre. Outil de finition pour ponçage de l'enduit afin d'obtenir la finition grattée-grésée. S'utilise en complément du gratton.



Dimensions mm	Grain	Ref.	☐
50 x 25 x 200	60	302220	1
50 x 25 x 200	16	302230	1

## TALOCHE P.U. MOUSSE RIGIDE POLYMERE ORANGE

Haute densité : 300 kg/m<sup>3</sup>. Bonne résistance à l'abrasion. Poignée plastique montée par queue d'aronde.



Dim. cm	Plateau	Ref.	☐
26 x 40	rectangulaire	316000	6
26 x 33	rectangulaire	316010	6
18 x 26	rectangulaire	316030	6
18 x 26	pointu	316042	6



## DÉBOUCHEUR DE BUSES

Pour déboucher les buses des machines à projeter.  
Ø mèche : 5 mm. Longueur totale : 26,5 cm.

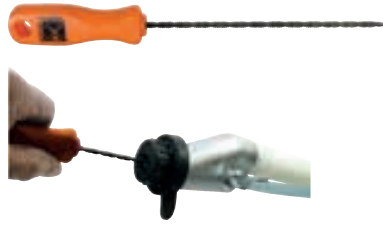

Longueur mèche cm	Ref.	📦
17	301450	1

## TALOREX

Pour lissage d'enduits. Permet de réaliser des effets. Semelle mousse PVC souple de 15 mm. Pointue. Monture bois. Poignée plastique.



Dim. cm	Ref.	📦
21 x 14	316100	1

## FROTTOIR EN POLYSTYRÈNE EXPANSÉ MONOBLOC

Pour le lissage du béton.  
Pour une surface plane et régulière. Bonne prise en main.



Dim. cm	Ref.	📦
15 x 20	316200	24
27 x 15	316210	24

## FROTTOIR BOIS AVEC SEMELLE CAOUTCHOUC NOIR

Permet de réaliser des effets. Poignée plastique. Épaisseur de la semelle caoutchouc : 14 mm.

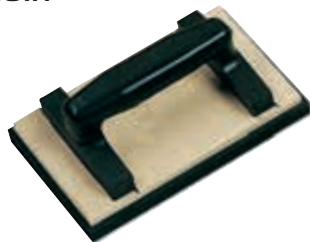

Dim. cm	Ref.	📦
13 x 20	317050	1

## FROTTOIR BOIS AVEC SEMELLE FEUTRE

Poignée plastique. Semelle feutre épaisseur 7 mm.

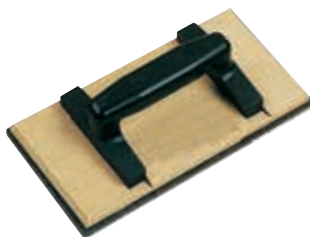

Dim. cm	Ref.	📦
14 x 25	317100	1

## ÉPONGE GRISE POUR CIMENTIER

En mousse polyuréthane grise. 17 x 11 x 6 cm.

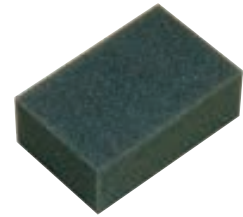

Conditionnement	Ref.	📦
Vrac	302400	12
Lot de 2	302402	1

## ÉPONGE DE MAÇON

En mousse polyuréthane alvéolée jaune.



Dim. cm	Ref.	📦
14 x 10 x 6	302410	12

## PLATOIR CAOUTCHOUC

Plateau aluminium.  
Manche bois. Semelle mousse caoutchouc.

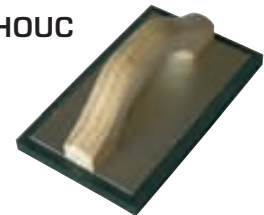

Dim. cm	Ref.	📦
21 x 13	316120	1

## MACHINE À CRÉPIR "LE MOUSTIC®"

Projection manuelle des enduits décoratifs. Carter en tôle électro-zinguée. 20 peignes en acier inoxydable interchangeables. Principe de détente arrêtée.



Ouverture mm	Ref.	📦
132 x 190	301210	1

	Ref.	📦
Hérissin complet de rechange	301220	1
Peigne de rechange standard	301230	1
Roulement lisse tubulaire (jeu de 2 petits + 1 grand)	301240	1
Coussinet caoutchouc (jeu de 2)	301250	1
Axe manivelle avec écrou + 2 roulements	301260	1

## MACHINE À CRÉPIR "LA GUEPE®"

Pratique pour crépir de petites surfaces. Cuve acier galvanisé. Peignes en métal ressort bleui. Grande fenêtre d'ouverture.



g	Ref.	📦
1830	301180	1

Pièce de projection	Ref.	📦
	301181	1



16



62



96



120



126



156



188



224



248



254



300



316



340



390



462



488



371

## I.T.E.

### UNE SOLUTION QUI SE DEVELOPPE

■ L'isolation thermique par l'extérieur (ITE) permet d'atteindre d'excellentes performances d'isolation globale, satisfaisant les exigences RT 2012 et BBC (suppression des ponts thermiques, protection de la façade, sauvegarde du même espace de vie à l'intérieur).

### 3 mises en œuvre principales, en fonction des conditions climatiques, de l'état du mur et de la hauteur du bâtiment :

- pose collée (construction), fibre de bois, polystyrène expansé (PSE) blanc ou en polystyrène expansé graphité gris
- pose calée-fixée (avec des chevilles dans le mur), en rénovation, pour tous les isolants
- fixation mécanique par profilés (cornière d'angle posée et panneaux qui s'emboîtent), en rénovation, pour le polystyrène.



Ergolame 30 cm pour les reprises



Ergolame 80 cm



### ERGOLAME® SPÉCIAL FACADIER DENTÉ

Pour la réalisation des façades, le collage des polystyrènes en isolation extérieure. Longueur 600 mm - Épaisseur 0,6 mm.



Largeur de lame mm	Forme dents	Dim. dents mm	Ref.	📦
120	Larges pointues	8 x 9	227920	2

### ERGOLAME® SPÉCIAL FACADIER DENTÉ

Pour l'enduit sans armature, le collage de la trame sur polystyrène en isolation extérieure. Longueur 600 mm - Épaisseur 0,6 mm.



Largeur de lame mm	Forme dents	Dim. dents mm	Ref.	📦
120	Carrée	8 x 8 x 8	227930	2

### ERGOLAME® DENTÉ 30CM

Pour le collage de la trame. Lame inox. Épaisseur : 0,6 mm.



Denture	L mm	Ref.	📦
Dents carrées 8 x 8 x 8	300	227830	2

### ERGOLAME® LISSAGE SPÉCIAL I.T.E.

Épaisseur : 0,6 mm.



Longueur mm	Largeur mm	Ref.	📦
150	100	227500	2
300	100	227510	2
500	100	227520	2
600	100	227530	2
800	100	227540	2

## RÈGLE À POIGNÉE UN CÔTÉ DENTÉ

Pour sous-enduit de façade. Profil aluminium avec un côté denté (dégrossissage) 5 x 5 mm et un côté lisse.



Dim. cm	Ref.	
80 x 10	226806	1
100 x 10	226816	1
120 x 10	226826	1

## PLATOIR MONTURE ALU DEUX MAINS DENTÉ LAME 0,6 MM

Pour colle ou sous-couche d'enduit. Poignée plastique ergonomique pour le travail à une ou deux mains. Lame inox dentée deux côtés.



Denture mm	L x l cm	Ref.	
6 x 6 x 6 (carrée)	50 x 12	232401	3
8 x 8 x 8 (carrée)	50 x 12	232421	3
10 x 10 x 10 (carrée)	50 x 12	232431	3

## PLATOIR DENTÉ MONTURE ALU LAME 0,6 MM 6 X 6 X 6

Poignée bi-matière. Toucher «soft». Lame inox dentée des deux côtés.



Denture mm	L x l cm	Ref.	
6 x 6 x 6 carrée	28 x 12	234641	3

## COUPEAU A ENDUIRE BRUT DE DÉCOFFRAGE

Renfort alu, lame inox trempé. Poignée bois.



Largeur cm	Hauteur de lame mm	Épaisseur mm	Ref.	
50	48	0,6	224500	1
60	48	0,6	224600	1

## TRUELLE ITALIENNE RONDE MANCHE BI-MATIÈRE

Manche bi-matière. Série Bâtiment Mondelin. Brochable par le manche.



L cm	Ø mm	Ref.	
20	9	338513	1
22	9	338523	1

## TRUELLE ITALIENNE CARRÉE MANCHE BI-MATIÈRE

Manche bi-matière. Série Bâtiment Mondelin. Brochable par le manche.



L cm	Ø mm	Ref.	
20	9	338563	1
22	9	338573	1

## TRUELLE LANGUE DE CHAT MANCHE BI-MATIÈRE

Manche bi-matière. Série Bâtiment Mondelin. Brochable par le manche.



L cm	Ø mm	Ref.	
16	8	338623	1

## TALOCHÉ NOIRE PLASTIQUE RECTANGULAIRE, POIGNÉE BOIS



Dim. cm	Ref.	
26 x 35	313110	6

## TALOCHÉ PRO ABS JAUNE, RECTANGULAIRE, POIGNÉE BOIS



Dim. cm	Ref.	
26 x 35	311310	6

## TRUELLE D'ANGLE INTÉRIEUR

Lame inox. Manche polypropylène ergonomique. Épaisseur : 0,6 mm. Angle 103°.



L x l mm	Ref.	
200 x 120	338100	1

## TRUELLE D'ANGLE EXTÉRIEUR

Lame inox. Manche polypropylène ergonomique. Épaisseur : 0,6 mm. Angle 87°.



L x l mm	Ref.	
200 x 120	338090	1



16



62



96



120



126



156



188



224



248



254



300



316



340



390



462



488



373

## OUTILS POUR I.T.E.

### MATÉRIAUX I.T.E.

Les matériaux isolants principaux sont :

- le polystyrène à fort pouvoir isolant
- la laine de roche
- la fibre de bois
- le béton cellulaire.

Ensuite, on pose par-dessus un enduit de finition comme sur une façade classique, ou un parement (briques, bardage, pierre, PVC).



I.T.E. en pose collée de polystyrène avec armature pour poser les couches d'enduit pour la façade

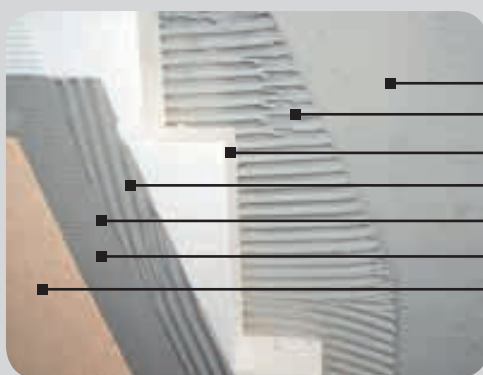

- mur
- colle
- isolant
- sous-enduit
- treilli souple
- sous-enduit
- enduit de finition



Isolation par laine minérale avec bardage

### PLATOIR-RAPE I.T.E.

Pour la finition des joints type béton cellulaire ou finition sur un doublage I.T.E. Grande longévité, évite la consommation d'abrasif.



Dim. cm	Ref.	📦
34 x 17	323000	1

### TALOCHE ABRASIVE I.T.E.

Pour poncer les panneaux d'isolation en polystyrène et le béton cellulaire. Poignée et monture bois. Grain de 16.



Dim. cm	Ref.	📦
16,5 x 25	322020	1
20 x 35	322010	1
25 x 50	322000	1

### TALOCHE-GRATTON

Connecteur interchangeable en tôle emboutie. Poignée bois.



Dim. cm	Nb pointes	Dim. pointes mm	Ref.	📦	Connecteur de recharge	📦
15 x 25	480	8	321210	6	321211	10

### MÉLANGEUR HÉLICE HÉLICOÏDALE PRO 120 S

Usage intensif. Pour mortier, enduits et mortiers de finition, chaux, béton, ciment, ragréage, isolation thermique et phonique.



Ref.	📦
881040	1

### PISTOLET SQUELETTE

Collage de pièces d'armature. Pour cartouches de 310 ml de mastic, silicone et colle. Corps et gâchette métalliques.

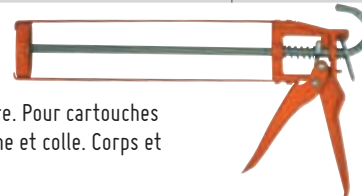

L cm	Ref.	📦
24	153710	1

### MARTEAU DE MENUISIER MANCHE BOIS

Haute qualité. Manche frêne PEFC.



C mm	L mm	📦 g tête	Ref.	📏	Coin	📦
26	280	315	040260201	6802	11	5



## COUPE POLYSTYRÈNE ÉLECTRIQUE

Pour une découpe rapide de panneaux isolants. Environ 5 mètres de câble. Livré dans une mallette. Équipé de 2 lames chauffées par une résistance électrique 220 V (17 cm et 19,5 cm).



Ref.			
830700		1	
Lame de 17 cm	Ref.		
	830701	1	
Lame de 19,5 cm	Ref.		
	830702	1	

## SCIE À MATÉRIAUX SPÉCIAL I.T.E.

Pour carreaux de plâtre, béton cellulaire et pierres tendres. Poignée ergonomique bi-matière. Grosse denture 2 dents au pouce, trempée, affûtage permanent. Lame épaisseur 1.4 mm, avec avoyage 2,7 mm.



Longueur cm	Ref.		
71	831750	1	

## COUTEAU POUR MATÉRIAUX D'ISOLATION MANCHE BI-MATIÈRE

Manche bi-matière toucher "Soft". Lame inox. Double denture. Avec étui de suspension.



L cm	Ref.		
28	830589	1	

## SCIE À MÉTAUX ALU

Poignée aluminium injecté. Référence Mob.



L mm	Lame	g	Ref.	
450	300	400	6369240010	1

## CISAILLE À TÔLE TYPE AVIATION

Adaptée à la découpe de pièces d'armature ITE. La forme des becs permet une coupe à droite, à gauche ou droite. Manche bi-matière toucher "Soft". Brochable.



Ref.		
503328	1	

## CUTTER MATÉRIAUX 25 MM

Pour couper la trame ITE. 1 lame renforcée épaisseur : 0,7 mm. Verrouillage par vis. Blocage automatique de la lame par molette de sécurité sur le guide métal. Manche bi-matière. Sur carte.



Épaisseur mm	Ref.	
0,7	103098	1

## RÈGLE ALUMINIUM

100 x 18 mm - 1 voile (2 alvéoles). Avec embouts plastique.

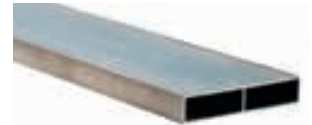

L m	Dim. mm	Ref.	
2	100 x 18	351200	5
3	100 x 18	351300	5

## NIVEAU PROFIL RECTANGULAIRE

Embouts amortisseurs des chocs. Profil aluminium.



Longueur cm	Ref.	
80	870800	1

## MESURE BOÎTIER G LOCK TAJIMA®

5m. Boîtier ABS surmoulé en élastomère anti-choc. Ruban avec revêtement nylon. Agrafe ceinture. Triple rivetage du crochet. Amortisseur retour ruban. Classe II. Sur carte.



Longueur m	Largeur mm	Ref.	
5	25	877158	6

## GANTS POLYAMIDE ENDUCTION NITRILE

Conforme aux normes Européennes EN 420 et EN 388. Protection 2121. 



	Sachet 10 paires		Cavalier 1 paire	
Taille	Ref.		Ref.	
8	801295	1	801294	1
9	801293	1	801292	1
10	801291	1	801290	1

## LUNETTES MASQUE MONTURE PVC SOUPLE

Aération par perforation latérale. Maintien par élastique de serrage réglable. Écran en acétate incolore. EN166. 



Ref.		
801890	1	



16



62



96



120



126



156



188



224



248



254



300



316



340



390



462



488



375

## COLORANTS SYNTHÉTIQUES

- Sols en ciment, dalles, chapes, carreaux, granito, terrazzo, mosaïques, enduits, crépis, pavés autobloquants, etc...
- Le colorant se mélange impérativement au ciment sec. Ajouter le sable, l'eau en dernier. Le dosage s'effectue au poids par rapport au ciment. Le pourcentage va de 1 à 6 %. Il est fonction de la teinte désirée. La densité du colorant varie selon la couleur.

### CARACTÉRISTIQUES

- La couleur reste stable quelque soit le matériau utilisé
- Grande diversité de couleurs à fort pouvoir colorant
- Attention : le rendu peut varier en fonction des quantités de pigment, mais aussi des agrégats utilisés. Il est donc très important d'effectuer un test sur une petite surface pour valider la couleur souhaitée, avant de commencer le chantier.



## COLORANTS SYNTHÉTIQUES

1100 ml.

Couleur	Ref.	📦
Noir intense	302470	6
Ton pierre	302480	6
Terre cuite	302490	6
Terre de Provence	302500	6
Rouge vif	302510	6
Rouge foncé	302520	6
Jaune clair	302530	6
Ocre	302540	6
Brun clair	302550	6
Brun foncé	302560	6
Noir	302570	6
Vert	302580	6
Bleu	302590	6



## COLORANTS NATURELS

### UTILISATION

- Badigeons à la chaux, enduits de parement, joints, enduits de décoration, enduits de façades...
- Utilisables avec chaux, plâtre et ciment
- Il est impératif d'effectuer le mélange ciment ou chaux + sable + colorant naturel à sec. Pour les badigeons, le pourcentage maximum de colorant naturel à utiliser est variable suivant la technique de badigeons
- Ce pourcentage peut aller de 10 à 95 % du poids de chaux aérienne éteinte utilisé

### CARACTÉRISTIQUES

- Les teintures sont miscibles entre elles



## COLORANTS SYNTHÉTIQUES, POT DE 3 KG

Couleur	📦 kg	Ref.	📦
Noir intense	3	302600	1
Rouge vif	3	302610	1
Rouge foncé	3	302620	1
Jaune clair	3	302630	1
Ocre	3	302640	1
Brun clair	3	302650	1
Brun foncé	3	302660	1
Noir	3	302670	1
Vert	3	302680	1
Bleu	3	302690	1



## COLORANTS SYNTHÉTIQUES, SACS DE 20 ET 25 KG

Sur commande.

Couleur	📦 kg	Ref.	📦
Noir intense	25	30247K	1
Rouge vif	25	30251K	1
Rouge foncé	25	30252K	1
Jaune clair	20	30253V	1
Ocre	25	30254K	1
Brun clair	25	30255K	1
Brun foncé	25	30256K	1
Noir	25	30257K	1
Vert	25	30258K	1
Bleu	25	30259K	1



## COLORANTS NATURELS

1000 ml.

Couleur	Ref.	📦
Oxyde noir	302900	1
Terre d'ombre calcinée	302910	1
Terre d'ombre naturelle	302920	1
Ocre rouge	302930	1
Ocre jaune foncé	302940	1
Ocre havane	302950	1
Terre de Sienna naturelle	302960	1



# MAÇON FAÇADIER C'EST AUSSI...

## RÈGLE ALU

>> PAGE 241



Ref.	
351300	4

## RÈGLE NIVEAU

>> PAGE 241



Ref.	
351620	1

## TRUELLE AUTHENTIQUE

>> PAGE 482



Ref.	
6002200101	1

## PULVÉRISATEUR

>> PAGE 505



Ref.	
853090	1

## GOULOTTE

>> PAGE 515



Ref.	
348010	1

## GRILLAGE

>> PAGE 516



Ref.	
802550	1

## HÉLICE HÉLICOÏDALE PRO 140 S

>> PAGE 509



Ref.	
881050	1

## PLOMB DE MAÇON

>> PAGE 247



Ref.	
815170	1

## CORDEAU-TRACEUR STOPLINE

>> PAGE 245



Ref.	
815000	6

## CHEVILLE DE MAÇON OCTOGONALE

>> PAGE 293



Ref.	
7164250001	10

## CISEAU DE MAÇON

>> PAGE 291



Ref.	
7171260001	1

## MASSETTE ANGLES ABATTUS TRI-MATIÈRE

>> PAGE 274



Ref.	
0136130704	1

## COFFREUR

>> PAGE 276



Ref.	
0478000701	1

## TRÉTEAU PLIANT PROFESSIONNEL RÉGLABLE, MÉTAL

>> PAGE 314



Ref.	
113050	1



## LISSARDE À BÉTON



### + LES PLUS

- Possibilité de lestage du plateau en aluminium afin d'adapter le lissage à la consistance du béton
- Bords remontants pour éviter d'accrocher le béton
- Poignées en tube acier peint, réglables en hauteur
- Articulation renforcée pour une meilleure longévité
- Montage et démontage rapide grâce à une goupille clips.

### UTILISATION

- Permet de répartir le béton tout en réglant la planéité, de pré-lisser et de faire remonter la laitance

### CARACTÉRISTIQUES

- Plateau aluminium.
- Poignées en tube acier peint, réglables en hauteur.

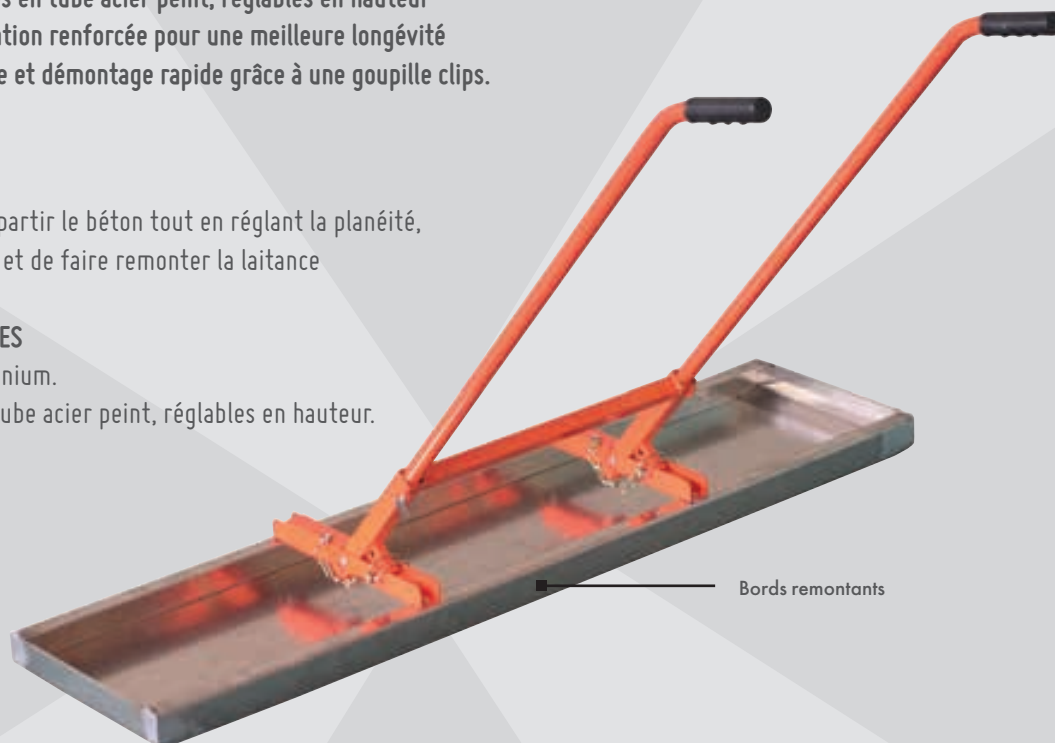

### COMPACITÉ

Les deux poignées démontables facilitent le transport et le rangement de la lissarde à béton



## LISSARDE À BÉTON

Pour la finition des dalles bétonnées.

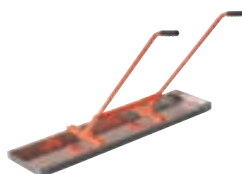

Dimensions m	kg	Ref.	
0,90 x 0,345	9	303300	1
1,40 x 0,345	11	303310	1
1,90 x 0,345	14	303320	1



## LISSEUSE À BÉTON



### UTILISATION

- A utiliser en complément de la lissarde pour de plus petites surfaces
- Pour le lissage des dalles bétonnées.

### CARACTÉRISTIQUES

- Profil aluminium, bout ogive
- Poignée fermée bi-matière toucher «Soft» pour une excellente prise en main.



## LISSEUSE À BÉTON

Pour le lissage des dalles bétonnées. Profil aluminium, bout ogive. Poignée fermée bi-matière toucher «Soft».



L m	Largeur cm	kg	Ref.	
1	10	1,2	226910	1

## BOUCHARDE TÉLESCOPIQUE

### + LES PLUS

- Outil extra-léger : rouleaux en résine de synthèse
- Livrée avec deux rouleaux facilement interchangeables, motifs mosaïque et diamant
- Manche télescopique en acier rond : ouverture maxi : 2,25 m.

### UTILISATION

- Pour la réalisation de motifs sur le béton, pour rendre la surface antidérapante par exemple.

### CARACTÉRISTIQUES

- Dimension du manche fermée : 1,30 m. Dimension du manche ouvert : 2,25 m.



## BOUCHARDE TÉLESCOPIQUE MOSAÏQUE + DIAMANT

Pour la réalisation de motifs sur le béton.



Dimensions m	kg	Ref.	
1,30 -> 2,25	2,50	303000	1

## BOUCHARDE ÉCONOMIQUE

Pour la réalisation de motifs sur le béton.



	L m	kg	Ref.	
Mosaïque	1,30	1,4	303040	1
Diamant	1,30	1,4	303050	1



16



62



96



120



126



156



188



224



248



254



300



316



340



390



462



488



379



## TRÉPIEDS FIXES REPÈRE DE NIVEAU



### + LES PLUS

- Système de réglage précis et facile à utiliser grâce au ressort zingué de blocage de la platine. Facilité de nettoyage car trépied sans filetage
- Livré avec une poignée pour faciliter le transport
- Réglable de 0 à 16,5 cm.
- Possibilité de poser la tige du laser sur le dessus de la tige
- Tige imperdable plus pratique

### UTILISATION

- Pour ajuster l'épaisseur des chapes liquides
- A disposer en quinconce tous les 1,50 m environ
- Le réglage de la platine ronde pour déterminer la hauteur de la chape se réalise avec un niveau à eau ou un niveau laser.

### CARACTÉRISTIQUES

- Acier zingué
- Trépied fixe
- Lot de 10 trépieds



### 10 TRÉPIEDS FIXES REPÈRE DE NIVEAU

Pour ajuster l'épaisseur des chapes liquides. Réglables de 0 à 16,5 cm.





## BARRE À DÉBULLER ACIER

### + LES PLUS

- Conception en acier pour une meilleure pénétration dans la chape
- Ergonomie des poignées pour une bonne prise en main
- Avec 2 poignées réglables et démontables pour faciliter le transport
- Réglable de 63 à 91 cm
- Confort de travail.

### UTILISATION

- Pour le débullage des chapes liquides.

### CARACTÉRISTIQUES

- Acier peinture époxy.
- Diamètre de la barre à débuller : 4,5 cm
- Livrée avec embouts plastique.

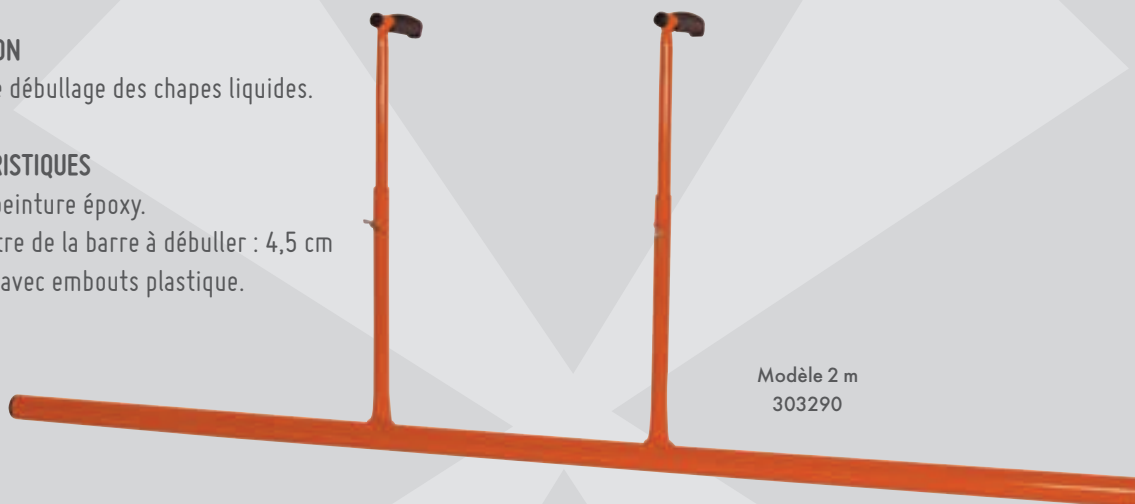

Poignées réglables et démontables



## BARRE À DÉBULLER ACIER

Pour le débullage des chapes liquides.



16



62



96



120



126



156



188



224



248



254



300



316



340



390



462



488

Dimensions m	kg	Ref.	☐
1	3,9	303270	1
1,50	4,7	303280	1
2	5,7	303290	1



## BARRE À DÉBULLER ALUMINIUM



### + LES PLUS

- **Légèreté** : conception en aluminium pour un outil plus léger afin de lutter contre les maladies professionnelles
- **Confort** : ergonomie des poignées plastiques pour une bonne prise en main
- **Maniabilité** : 4 hauteurs réglables, 750, 800, 850 et 900 mm
- **Equipée de 2 poignées réglables et démontables** pour faciliter le transport.

### UTILISATION

- Pour le débullage des chapes liquides.

### CARACTÉRISTIQUES

- Barre en aluminium.
- Dispo en deux diamètres de barre à débuller : 2,5 et 5 cm.



Modèle  
1,50 m  
303250

Finition de la chape



### BARRE À DÉBULLER ALUMINIUM Ø50 MM

Pour le débullage des chapes liquides.

Dimensions m	kg	Ref.	☐
1	2,05	303240	1
1,50	2,4	303250	1
2	2,75	303260	1



### BARRE À DÉBULLER ALUMINIUM Ø25 MM POIGNÉES RÉGLABLES

Pour le débullage des chapes liquides fines.  
Poignées réglables et rétractables.

Dimensions m	Ref.	☐
1	303241	1
1,50	303251	1
2	303261	1





## BALAI À DÉBULLER



### UTILISATION

- S'utilise en complément de la barre à débuller.
- Avec 2 poignées réglables et démontables pour faciliter le transport.

### CARACTÉRISTIQUES

- Acier peinture époxy
- Monture bois
- Fibre nylon
- Sortie de la fibre : 10 cm.



Finition de la chape



## BALAI À DÉBULLER

Pour la finition de la chape.

Dimensions m	Ref.	📦
0,80	303350	1
1,50	303360	1



## BROSSE DE RECHANGE POUR BALAI À DÉBULLER



Dimensions m	Pour ref.	Ref.	📦
0,80	303350	303351	1
1,50	303360	303361	1

## ROULEAU À DÉBULLER

### UTILISATION

- Pour débulage des ragréages autolissants et des chapes minces auto-nivelantes (inférieures à 20 mm).
- Pratique sur de petites surfaces type marches d'escalier.



## ROULEAU À DÉBULLER 45 CM

Ø : 11 cm.  
Hauteur des picots 3 cm.  
Possibilité d'adapter un manche.



L cm	Ref.	📦
45	303380	1

## ROULEAU À DÉBULLER 23 CM

Ø : 11 cm.  
Hauteur des picots 3 cm.  
Avec poignée.



L cm	Ref.	📦
23	303370	1



16



62



96



120



126



156



188



224



248



254



300



316



340



390



462



488



## CHEMIN DE FER DENTÉ



### UTILISATION

- Pour ravaler les façades, gratter la pierre ou les enduits.

### CARACTÉRISTIQUES

- 6 lames acier au pas de 3
- Poignée bois
- 2 gammes : avec ou sans dents



Réalisation de poignées sur notre centre d'usinage à commande numérique.

## CHEMIN DE FER DENTÉ

Pour ravaler les façades, gratter la pierre ou les enduits.

**FAÇADIER**



L cm	Ref.	📦	
25 x 5	301050	3	
25 x 7	301070	3	
25 x 9	301090	3	
lame chemin de fer denté	L m	Ref.	📦
	1	301150	1

## CHEMIN DE FER SANS DENT

Pour ravaler les façades, gratter la pierre ou les enduits. Sans dent.

**FAÇADIER**



Dim. cm	Ref.	📦
25 x 7	301080	3
25 x 9	301100	3

## CHEMIN DE FER PLAT, DENTÉ POUR PIERRE TENDRE

Pas de 2. Plat denté. 12 lames acier. Poignée bois.



Dim. cm	Ref.	📦	
30 x 2	300920	1	
30 x 4	300940	1	
30 x 7	300970	1	
lame chemin de fer plat denté	L m	Ref.	📦
	1	301160	1

## CHEMIN DE FER ROND DENTÉ POUR PIERRE TENDRE

12 lames acier convexes. Poignée bois.



Dim. cm	Ref.	📦
30 x 2	301010	1
30 x 3	301020	1
30 x 4	301030	1
30 x 5	301040	1

## FER À MARCHÉ PLASTIQUE

Pour arrondir les angles des réalisations en béton (ex : marches). Hauteur : 9 cm



L cm	Ref.	📦
14	302200	6

## FER À MARCHÉ FONTE

Pour arrondir les angles des réalisations en béton (ex : marches). Hauteur : 9 cm



L cm	Ref.	📦
13,50	302210	1

# DALLAGISTE C'EST AUSSI...

PLATOIR DEUX MAINS LAME INOX  
BISEAUTÉE 0,7 MM

>> PAGE 465

Ref.	
232231	4



FROTTOIR PLASTIQUE  
SPONGIEUX ORANGE

>> PAGE 371

Ref.	
317020	1



PLATOIR FLAMAND CHAPISTE

>> PAGE 471

Ref.	
233231	1



RÈGLE ALU

>> PAGE 241

Ref.	
351300	4



PULVÉRISATEUR

>> PAGE 505

Ref.	
853090	1



HÉLICE HÉLICOÏDALE PRO 140 S

>> PAGE 509

Ref.	
881050	1



TALOCHE BOIS

>> PAGE 366

Ref.	
314020	1



POUDRE À TRACER 400 G

>> PAGE 244

Ref.	
814360	6



PLOMB DE MAÇON

>> PAGE 247

Ref.	
815170	1



CORDEAU-TRACEUR STOPLINE

>> PAGE 245

Ref.	
815000	6



GRATTOIR

>> PAGE 345

Ref.	
6361000010	10



RACLOIR À BITUME

>> PAGE 346

Ref.	
6453000010	1



ÉPANDEUR

>> PAGE 347

Ref.	
6155000001	1



RATEAU

>> PAGE 346

Ref.	
6450161010	1





## ÉTAI TIRANT-POUSSANT



### UTILISATION

- Aide à la mise en place, au maintien et au réglage des éléments bois (partie haute des murs)

### CARACTÉRISTIQUES

- Équipé d'un point d'ancrage (modèle déposé) pour utiliser le plomb spécial ossature bois (réf. 403500)
- Réglable de 10 en 10 cm et réglage millimétrique de 30 cm grâce à la poignée double pour rotation
- Les platines sont percées de trous Ø 6,5 mm pour fixation dans le bois et de trous Ø 11 mm pour fixation dans le béton
- Peinture époxy orange.

Les deux platines de fixation et la poignée de réglage sont communes aux deux étais réf. 401000 et 401100



Platine de fixation dans le bois



Poignée de réglage millimétrique



Platine de fixation dans le sol



### ÉTAI TIRANT-POUSSANT 300 KG

Charge maxi admissible : 300 kg.  
Extensible de 2,10 m à 3,20 m.  
Réglable. Fût : tube carré 35x35x2 mm.  
Coulisse : tube carré 30x30x2 mm.



### ÉTAI TIRANT-POUSSANT 200 KG

Charge maxi admissible : 200 kg.  
Extensible de 1,60 m à 2,60 m.  
Réglable. Fût : tube rond 33,7x2 mm.  
Coulisse : tube rond 27x2 mm.



Charge maximum kg	Extensible de	kg	Ref.	📦
300	2,10 > 3,20 m	8,8	401000	1

Charge maximum kg	Extensible de	kg	Ref.	📦
200	1,60 > 2,60 m	5,4	401100	1



## PLOMB POUR ÉTAI



S'adapte sur les platines des deux étais réf. 401000 et 401100. Idéal pour régler et contrôler l'aplomb de l'élément étagé. Plomb livré avec cordeau sans platine.



Dimensions	g	Ref.	☐
N° 45	450	403500	1

## ÉTAI DE COIN



### UTILISATION

Utilisé à l'horizontal, il permet de régler l'angle d'équerrage de deux panneaux et de les ajuster l'un par rapport à l'autre.

### CARACTÉRISTIQUES

- Réglage millimétrique de 20 cm grâce à la poignée double
- Tube rond Ø 26,9 x 2 mm. Les platines sont percées de trous Ø 6,5 mm pour fixation dans le bois
- Peinture époxy orange.



## ÉTAI DE COIN

Utilisé à l'horizontal, il permet de régler l'angle d'équerrage de deux panneaux et de les ajuster l'un par rapport à l'autre.



kg	Ref.	☐
2	401500	1

## POSE-LAME

### + LES PLUS

- Permet le redressage des lames cintrées et un serrage optimum sans déformer la lame
- Le blocage du pose-lame permet d'avoir les 2 mains libres pour la fixation de la lame.

### UTILISATION

- Aide à la pose des lames de bois en terrasse.

### CARACTÉRISTIQUES

- Possibilité d'utiliser cet outil par paire
- Livré avec 3 cales réversibles pour espace de 5 ou 7 mm entre les lames
- Indexation fixe pour lames de largeur 80 à 210 mm
- Peinture époxy orange



Position avant serrage

Position bloquée



## POSE-LAME

Permet le redressage des lames cintrées et un serrage optimum sans déformer la lame. Aide à la pose des lames de bois en terrasse.



kg	Ref.	☐
1,5	403000	1



16



62



96



120



126



156



188



224



248



254



300



316



340



390



462



488



## 4 CALES RÉVERSIBLES POUR POSE-LAME, 5/7 MM

Kit de 4 cales réversibles pour pose-lame réf. 403000. Couleur noire.



Pour espaces de mm	Ref.	
5 > 7	403010	1

## 4 CALES RÉVERSIBLES POUR POSE-LAME 4/6 MM

Kit de 4 cales réversibles pour pose-lame réf. 403000. Couleur rouge.



Pour espaces de mm	Ref.	
4 > 6	403011	1

## TIRE-MUR



### + LES PLUS

- La forme de la semelle de l'outil permet de tirer le mur en positionnant le pied à l'arrière de la semelle, sans avoir à fixer celle-ci au sol
- La semelle et le pic sont conçus sous forme de chape pour une meilleure robustesse
- 2 positions de réglage suivant la hauteur de la lisse d'assise.

### UTILISATION

- Pour la mise en place des panneaux bois d'une maison à ossature bois
- Permet de régler la position du bas du mur par rapport à la lisse d'assise
- Permet d'ajuster la lisse basse du panneau sur la lisse d'assise (R.D.C.) ou sur le plancher bois (à l'étage)

### CARACTÉRISTIQUES

- Dimensions : 620 x 70 x 270 mm
- En acier épaisseur 3, 4 et 6 mm
- Finition époxy.



Lisse d'assise

## TIRE-MUR

Pour la mise en place des panneaux bois d'une maison à ossature bois.



kg	Ref.	
2,8	401600	1

## CALES D'ÉPAISSEUR



### UTILISATION

- Pour le calage de plancher bois type terrasse ou parquet et pour tous travaux de menuiserie intérieurs et extérieurs.
- Aussi appelée cale plate ou cale millimétrée.

### EXCLUSIF

- Seule cale sécable du marché. Chaque cale (plaquette de 80x60mm) est sécable en 2 ou en 4 soit la possibilité d'avoir 4 cales avec une plaquette.

### CARACTÉRISTIQUES

- 1 couleur par épaisseur pour un repérage rapide (2mm : vert / 3mm : bleu / 5mm : noir)
- Les différentes cales sont empilables par un système d'ergot. Possibilité de régler sa hauteur tous les mm à partir de 2mm. Les ergots sont sécables et peuvent être enlevé à tous moment en cas de gêne.
- Trous pour vis de fixation sans percer la cale.
- Forte résistance à la pression. Spécial forte charge.
- En PP et non PEHD comme la plupart des acteurs du marché. Les cales ne se déforment pas.

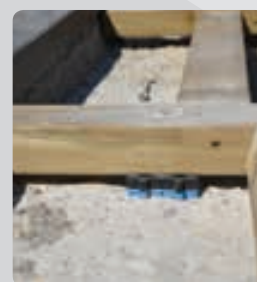

## CALES D'ÉPAISSEUR

Épaisseur 2, 3 et 5 mm.  
Sachet de 3 x 25 plaques sécables, soit jusqu'à 3 x 100 cales.

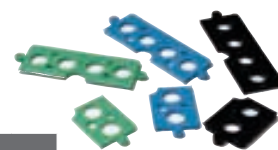

	Ref.	
Sachet brochant de 75 (3x25) pièces	812118	1

## CALES D'ÉPAISSEUR

Épaisseur 2, 3 et 5 mm.  
Seau de 3 x 100 plaques sécables, soit jusqu'à 3 x 400 cales.

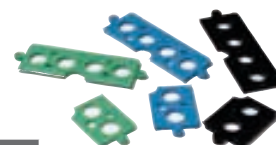

	Ref.	
Seau de 300 (3x100) pièces	812100	1

## CALES CRANTÉES

### + LES PLUS

- Calage précis grâce au profil dents de scies des cales
- Permet de rattraper jusqu'à 40 mm de jeu
- Peuvent être vissées, clouées, collées.
- Empilables avec les cales plates

### UTILISATION

- Pour le calage de plancher bois type terrasse ou parquet et pour tous travaux de menuiserie intérieurs et extérieurs.
- Corrigent les écarts de hauteur
- Isolent et préviennent de tout risque de pourrissement du bois

### CARACTÉRISTIQUES

- En PP chargé, résiste à une compression de 2 tonnes.
- Résiste aux températures extrêmes : -30° à +60°C



### CALES CRANTÉES, SEAU MIXTE DE 80 PIÈCES

Seau mixte de cales crantées  
50 x 90 mm et 30 x 170mm

Ref.	📦
812160	1



### CALES DOUBLES CRANTÉES 170 MM

Cales sécables 11 à 40 mm

	Ref.	📦
Sachet brochant de 25 pièces	812138	1
Seau de 50 pièces	812120	1



### CALES CRANTÉES 90 MM

Cales 14 à 20 mm

	Ref.	📦
Sachet brochant de 30 pièces	812158	1
Seau de 100 pièces	812140	1



### BIBER BAR

>> PAGE 293

Ref.	📦
0113010015	1



### TENAILLE DE MENUISIER

>> PAGE 177

Ref.	📦
6362180010	1
6362220010	1
6362250010	1



### GORILLA GRIPPER

>> PAGE 389

Ref.	📦
0114401000	1



### MARTEAU DE CHARPENTIER

>> PAGE 278

Ref.	📦
5130070000	1



### SCIE ÉGOÏNE NERTEHCUT II

>> PAGE 192

Ref.	📦
6349500001	1



### CISEAU DE CHARPENTIER

>> PAGE 292

Ref.	📦
7035300001	5



### CISEAU DE SCULPTEUR

>> PAGE 221

Ref.	📦
7020201201	1









## PLAQUISTE

P.392

| POSER LA PLAQUE  
LEVPANO

P.403

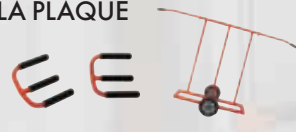
| TRANSPORTER  
LA PLAQUE

P.410

| TRAVAILLER  
LES RAILS - PINCES

P.413

| TRAVAILLER  
LA PLAQUE

P.419

| JOINTER ET PONCER



## PLÂTRIER PEINTRE

P.424

| TRAVAIL DU PLÂTRE



P.433

| ENCOLLAGE  
DES MURS ET PAPIERS

P.435

| COUPE, ÉPONGE



P.436

| PEINTURE : BROSSES  
ET ROULEAUX

## CARRELEUR

P.444

| COUPE DES CARREAUX



P.448

| OUTILS  
DE POSE

P.451

| COLLAGE DES CARREAUX

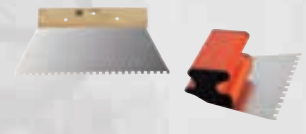

P.454

| JOINTS CARRELAGE



# PLAQUISTE 30 ANS D'HISTOIRE...

C'est en 1976 que ROGER MONDELIN crée le premier LEVPANO®, il est le premier fabricant d'outils de plaquiste en France. Dès sa commercialisation, le LEVPANO® rencontre un réel succès auprès des professionnels. L'entreprise dépose son premier brevet en 1989. Depuis 1976, le bureau d'études travaille en permanence sur la gamme LEVPANO® et dépose régulièrement des brevets.



1976

Création du 1<sup>er</sup> LEVPANO qui deviendra le LEVPANO I.  
1<sup>er</sup> lève-plaque en France

- Hauteur de pose : 3,35 m.
- Charge utile : 30 kg
- Entraînement de la colonne par chaîne + pignon.



1990

Lancement du LEVPANO® II.

- Hauteur de pose : 3,50 m ou 4 m avec rallonge.
- Tête orientable pour pose de plaque sous rampant.
- Les LEVPANO® I et II sont désormais entraînés par un treuil + 1 câble.
- Charge utile : 65 kg.



1999

Lancement du LEVPANO® ELECTRIQUE.



2007

Nouveau système de basculement et de verrouillage de la tête du LEVPANO® I et II

1976



1977

1<sup>er</sup> modèle déposé.



1997

Les LEVPANO® I et II sont équipés du système de sécurité anti-chute (breveté) constitué d'un câble de travail et d'un câble de sécurité. Certification CE.



2005

La charge utile des LEVPANO® I et II est de 75 kg.  
Lancement du LEVPANO COMBI® 400. Pose horizontale sous plafond, sous rampants, verticale sur cloisons.

- Charge utile 80 kg.
- Pose horizontale : 3,60 m.
- Pose verticale : 5 m (5,40 m avec rallonge).
- 3 brevets déposés.

# ÉVOLUTION GAMME LEVPANO



2007

Lancement du **LEVANO MASTER®**.  
 ■ Hauteur de pose horizontale : 4,50 m.



2011

Rallonge intégrée aux **LEVANO® I et II** (breveté).  
 ■ Hauteur de pose 4 m.



2013

**LEVANO® I 6** brevets et 1 modèle déposé.  
 ■ Pieds pour un appareil plus robuste.  
 ■ Support de treuil, plus ergonomique, facile à transporter.  
 ■ Goupille avec chaînette : gain en praticité.



2017

**LEVANO® I et II Premium**  
 ■ Pose verticale  
 ■ Hauteur de pose : 4,5 m  
 ■ Platine rotative



2008

Lancement du **LEVANO COMBI® 450**  
 ■ Hauteur de pose horizontale : 4,50 m,  
 ■ Verticale : 5,90 m.

2012

**LEVANO® I et II :**  
 Nouveaux bras pour la pose de plaques de toutes dimensions : 0,60 m - 0,90 m - 1,20 m (breveté).



## CHOISIR SON LEVPANO®

Type de LEVPANO®	Plateforme	Type de pose	Hauteur de pose	Hauteur de chargement	Charge utile	Poids de l'appareil
<b>LEVANO® I</b> réf. 513000	Avec plateforme	Horizontale Sous rampants Verticale	horizontale 4,50 m verticale 5,90 m	0,82 m	75 kg	52 kg
<b>LEVANO® II</b> réf. 514000	-	Horizontale Sous rampants Verticale	horizontale 4,50 m verticale 5,90 m	0,82 m	75 kg	43 kg
<b>LEVANO MASTER®</b> réf. 516000	Avec plateforme	Horizontale Sous rampants	horizontale 4,10 m	0,69 m	80 kg	53 kg
<b>LEVANO COMBI® 400</b> réf. 516500	Avec plateforme	Horizontale Sous rampants Verticale intensive	horizontale 4 m verticale 5,40 m	0,68 m	80 kg	53 kg
<b>LEVANO COMBI® 450</b> réf. 517000	Avec plateforme	Horizontale Sous rampants Verticale intensive	horizontale 4,50 m verticale 5,90 m	0,81 m	80 kg	55 kg





## LEVPANO® I AVEC PLATEFORMES UNIQUE, SÛR, PERFORMANT, RÉSISTANT, MANIABLE ET PRATIQUE



**RALLONGE INTÉGRÉE À LA TÊTE**  
pour pose jusqu'à 4,50 m à l'horizontale.  
Indexation tous les 10 cm.

**BREVETÉ**



**2 SABOTS MÉTALLIQUES**  
pour les poses sous rampants  
et verticale



**NOUVEAUTÉ**

**PLATINE DE ROTATION**  
de l'ensemble tête + bras = gain de temps, plus  
besoin de démonter les bras pour passer de la pose  
horizontale à la pose sous rampants ou verticale



**SABOTS ESCAMOTABLES**  
positionnés sur les bras centraux longs  
pour plaques de largeur 1,20 m.  
Adaptable sur les bras centraux courts  
pour les plaques de 0,60 et 0,90 m de large.

**BREVETÉ**



**NOUVEAUTÉ**

**POIGNÉE DE MANŒUVRE ERGONOMIQUE  
DES BRAS ET DE LA TÊTE AVEC LEVIER  
POUR INCLINAISON DE LA POUTRE**  
excellente prise en main

**BREVETÉ**



**POIGNÉE DE SUPPORT DE TREUIL  
ERGONOMIQUE**  
Permettant un bon dégagement  
et pratique pour un  
transport facile.

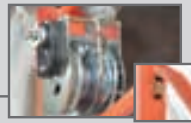

**SYSTÈME DE SÉCURITÉ**

constitué de 2 câbles :  
- 1 câble de travail  
- 1 câble de sécurité anti-chûte.

**BREVETÉ**



**BRAS CENTRAUX RÉGLABLES**  
pour la pose des 3 formats de plaques :  
0,60 m - 0,90 m et 1,20 m.

**BREVETÉ**

Goupille avec chaînette, gain en praticité.

**8 PATINS ANTIDÉRAPANTS**  
pour un excellent maintien et  
une bonne protection de la plaque.

**MODÈLE  
DÉPOSÉ**

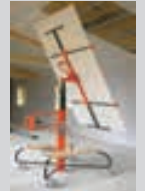

**STABILITÉ OPTIMALE  
GRÂCE AUX 8 POINTS D'APPUI**

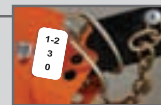

**RÉGLAGE RAPIDE 3 POSITIONS DU PIÈTEMENT**

0 : pour le transport  
1 et 2 : pour la pose horizontale et sous rampants  
3 : pour la pose verticale  
Réglage pratique grâce à la goupille imperdable.

**NOUVEAUTÉ**



**SYSTÈME DE FREINAGE INTÉGRÉ  
AU TREUIL ANTI-RETOUR**  
fixé sur la poignée de guidage.  
Cela permet une grande maniabilité  
de l'appareil.



**PIEDS ROBUSTES EMPATTEMENT DE 0,90 X 0,90 M**  
permettant une grande stabilité avec des  
plaques de grande dimension.  
4 roues de Ø 125 mm dont 2 équipées d'un  
système de blocage du pivot et du roulage.  
Equipé de 2 roulettes de transport.



**VIS IMPERDABLE**  
Montage rapide des planches.



**2 PLATEFORMES DE TRAVAIL POUR LA FIXATION DE LA PLAQUE  
LORS DE LA POSE HORIZONTALE ET SOUS RAMPANTS 0,83 x 0,25 m.**  
- Épaisseur : 25 mm  
- Résistance d'une plateforme : 150 kg  
- Hauteur : 0,49 m.  
**PLATEFORMES DE TRAVAIL  
RÉSISTANCE : 150 KG**



**TRANSPORT FACILE**  
EMPATTEMENT RÉDUIT  
PASSAGE D'UNE PORTE DE 0,73M  
SANS REPLIER LE PIÈTEMENT

# PLAQUISTE : LEVPANO® I



## + LES PLUS

- Hauteur de pose à l'horizontale : jusqu'à 4,50 m.
- Hauteur de pose à la verticale : jusqu'à 5,90 m.
- Pose de plaques de plâtre à l'horizontale, sous rampants et verticale
- Pour la pose de plaques de plâtre de toutes largeurs : 0,60 - 0,90 et 1,20 (breveté)
- Plateformes de travail pour le vissage de la plaque, charge utile : 150 kg.
- Simple et pratique : rotation de la tête pour le passage de la pose horizontale à verticale et sous rampants
- Excellent maintien et bonne protection de la plaque de plâtre quelle que soit sa dimension grâce aux 2 bras centraux équipés de sabots et de 2 bras de bout télescopiques.
- Passage dans une porte de 0,73 m sans replier le piètement.
- Montage/démontage rapide.
- Faible encombrement



Pose horizontale jusqu'à 4,50 m



Pose sous rampants



Pose verticale jusqu'à 5,90 m  
(usage non intensif, sinon privilégier le LEVPANOCOMBI)

## SÛR

- Système de sécurité breveté constitué de deux câbles :
  - 1 câble de travail
  - 1 câble de sécurité anti-chute
- Grande stabilité de l'appareil grâce aux 8 points d'appui.

## QUALITÉ

- Conforme à la norme **CE** et à la directive européenne 2006/42/CE.
- Examen de conformité réalisé par SOCOTEC.
- Montage et contrôle unitaire avant expédition
- Contrôles et tests de charges effectués par notre service qualité.

## MANIABILITÉ

- Nouveau : pas besoin de démonter les bras pour passer de la pose horizontale à la pose sous rampants ou verticale, grâce à la platine rotative

- Treuil anti-retour fixé sur la poignée de manoeuvre permettant un très bon guidage de l'appareil.
- Poignée de basculement des bras et tête ergonomique (breveté) pour une très bonne prise en main.

## PERFORMANT ET RÉSISTANT

- Pour une hauteur de pose comprise entre 3,50 m et 4,50 m, l'indexation de la partie supérieure de la colonne permet un réglage facile et rapide.
- Hauteur de chargement pose horizontale : 0,82 m pour une pose à 3,50 m à l'horizontale.
- La hauteur de chargement est fonction de la hauteur de pose comprise entre 3,50 m et 4,50 m.
- Hauteur minimale plaque horizontale : 1,45 m.
- Charge maximum : 75 kg

## CARACTÉRISTIQUES

- 2 plateformes de travail pour fixation de la plaque

- lors de la pose horizontale et sous rampants
- Dimensions : 0,83 x 0,25 m, épaisseur : 25 mm.
- Résistance d'une plateforme : 150 kg.
- Hauteur du sol : 0,49 m.

- Longueur des 2 bras centraux équipés de sabots : 1,10 m pour plaques de 1,20 m.
- 0,55 m pour plaques de 0,60 m et 0,90 m.
- Distance entre les bras centraux : 1 m.
- Longueur des 2 bras de bout télescopiques : 0,49 m.
- Ouverture maximum entre les 2 bras de bout : 3,10 m
- Angle de chargement par rapport à la colonne : 25°.
- La mobilité de la tête sur son axe permet un ajustement automatique de la plaque sous les fourrures, quelle que soit l'inclinaison du rampant.
- 4 roues dont 2 équipées d'un système de blocage du pivot et du roulage.
- Peinture époxy.
- Poids de l'appareil : 52 kg.

## LEVPANO® I

Pose horizontale, sous rampants et verticale.

Hauteur de pose m	Hauteur de chargement m pour pose horizontale	Hauteur plateforme m	Charge maximum kg	kg	Ref.	📦
4,5	0,82	0,49	75	52	513000	1

Kit de rechange 2 câbles	Ref.	📦
A boucle	PRO298	1
A embout	PRO012	1



16



62



96



120



126



156



188



224



248



254



300



316



340



390



462



488



995



# PLAQUISTE : LEVPANO® II



## + LES PLUS

- Hauteur de pose à l'horizontale : jusqu'à 4,50 m.
- Hauteur de pose à la verticale : jusqu'à 5,90 m.
- Pose de plaques de plâtre à l'horizontale, sous rampants et verticale
- Pour la pose de plaques de plâtre de toutes largeurs : 0,60 - 0,90 et 1,20 (breveté)
- Simple et pratique : rotation de la tête pour le passage de la pose horizontale à verticale et sous rampants
- Excellent maintien et bonne protection de la plaque de plâtre quelle que soit sa dimension grâce aux 2 bras centraux équipés de sabots et de 2 bras de bout télescopiques.
- Passage dans une porte de 0,73 m sans replier le piètement.
- Montage/démontage rapide.
- Faible encombrement



Pose horizontale jusqu'à 4,50 m



Pose sous rampants



Pose verticale jusqu'à 5,90 m  
(usage non intensif, sinon privilégier le LEVPANOCOMBI®)

### SÛR

- Système de sécurité breveté constitué de deux câbles :
  - 1 câble de travail
  - 1 câble de sécurité anti-chute.
- Grande stabilité de l'appareil grâce aux 8 points d'appui.

### QUALITÉ

- Montage et contrôle unitaire avant expédition
- Contrôles et tests de charges effectués par notre service qualité
- Conforme à la norme **CE** et à la directive européenne 2006/42/CE.
- Examen de conformité réalisé par SOCOTEC.

### MANIABILITÉ

- Nouveau : pas besoin de démonter les bras pour passer de la pose horizontale à la pose sous rampants ou verticale, grâce à la platine rotative
- Treuil anti-retour fixé sur la poignée de manoeuvre permettant un très bon guidage de l'appareil.

### PERFORMANT ET RÉSISTANT

- Pour une hauteur de pose comprise entre 3,50 m et 4,50 m, l'indexation de la partie supérieure de la colonne permet un réglage facile et rapide.
- Hauteur de chargement pose horizontale : 0,82 m pour une pose à 3,50 m à l'horizontale.
- La hauteur de chargement est fonction de la hauteur de pose comprise entre 3,50 m et 4,50 m.
- Hauteur minimale plaque horizontale : 1,45 m.
- Charge maximum : 75 kg

### CARACTÉRISTIQUES

- Longueur des 2 bras centraux équipés de sabots :
  - 1,10 m pour plaques de 1,20 m.
  - 0,55 m pour plaques de 0,60 m et 0,90 m.
- Distance entre les bras centraux : 1 m.
- Longueur des 2 bras de bout télescopiques : 0,49 m.
- Ouverture maximum entre les 2 bras de bout : 3,10 m
- Angle de chargement par rapport à la colonne : 25°.
- La mobilité de la tête sur son axe permet un ajustement automatique de la plaque sous les fourrures, quelle que soit l'inclinaison du rampant.
- 3 roues dont 2 équipées d'un système de blocage du pivot et du roulage.
- Peinture époxy.
- Poids de l'appareil : 43 kg.

## LEVPANO® II

Pose horizontale, sous rampants et verticale.

Hauteur de pose m	Hauteur de chargement m pour pose horizontale	Charge maximum kg	kg	Ref.	📦
4,5	0,82	75	43	514000	1
Kit de rechange 2 câbles		Ref.	📦		
A boucle		PRO298	1		
A embout		PRO012	1		



16



62



96



120



126



156



188



224



248



254



300



316



340



390



462



488



# PLAQUISTE : LEVPANO MASTER®

## LEVPANOMaster® IDÉAL POUR LES CHARGES LOURDES



**BRAS CENTRAUX RÉGLABLES**  
pour la pose des 3 formats de plaques :  
0,60 m – 0,90 m et 1,20 m.

**BREVETÉ**

Goupille avec chaînette, gain en praticité.

### SABOTS ESCAMOTABLES

positionnés sur bras central long pour  
plaques de largeur 0,90 m et 1,20 m.  
Adaptable sur le bras central court  
pour les plaques de 0,60 m de large.

**BREVETÉ**

**MODÈLE  
DÉPOSÉ**

**PATINS  
ANTIDÉRAPANTS**  
pour un excellent  
maintien et une  
bonne protection  
de la plaque



**TÊTE DE BASCULEMENT**  
des bras brevetée.  
Tête équipée d'une poignée

**BREVETÉ**

**BRAS TÉLESCOPIQUES  
ET REPLIABLES**  
pivotant sur 360° avec  
système de blocage grâce  
aux 6 indexations fixes de  
l'appareil.



**2 SABOTS MÉTALLIQUES**  
pour la pose sous rampants.

**SYSTÈME DE SÉCURITÉ**  
constitué de 2 câbles :  
1 câble de travail et  
1 câble de sécurité anti-chute

**BREVETÉ**

**POIGNÉE DE BASCULEMENT  
DES BRAS ET TÊTE ERGONOMIQUE**

**BREVETÉ**

### PLATEFORME

Véritable plateforme de travail sur laquelle le plaquiste  
peut monter pour fixer la plaque de plâtre

- Hauteur : 0,49 m
- Epaisseur : 25 mm.

**COLONNE EN ALUMINIUM**  
permettant une charge utile de 80 kg

**MODÈLE  
DÉPOSÉ**

**EMPATTEMENT**  
de 1,02 x 1,02 x 1,02 m

516000



### 2 ROULETTES

fixées à la base de la colonne  
facilitent le transport.

### ROUES FORTES CHARGES

3 roues Ø 160 mm facilitant les déplacements sur sol brut  
en particulier avec des plaques coupe-feu ou plaques de  
gypse et de cellulose plus lourdes.





## + LES PLUS

- Excellent maintien et bonne protection de la plaque de plâtre quelle que soit sa dimension grâce aux 2 bras centraux équipés de sabots et de 2 bras de bout télescopiques.
- Montage/démontage rapide.
- Faible encombrement.
- Equipé d'une poignée de basculement (breveté).
- Empattement réduit réglable pour franchir les portes : 1,02 x 1,02 x 1,02 m
- Charge utile 80 kg.



- 3 éléments :
- Tête, colonne et piètement
  - Bras
  - Plateforme



Chargement d'une plaque de 1,20 m x 2,50 m en vue d'une pose horizontale.



Chargement d'une plaque de 1,20 m x 2,50 m en vue d'une pose sous rampants.



Chargement d'une plaque de 0,60 m x 2,50 m en vue d'une pose horizontale.



### UTILISATION

- Pose horizontale et sous rampants de plaques, y compris les plaques lourdes coupe-feu ou plaques de gypse et de cellulose.
- Plateforme pour un accès direct à la hauteur de fixation sous plafond.

### SÛR

- Système de sécurité breveté constitué de deux câbles :
  - 1 câble de travail
  - 1 câble de sécurité anti-chute

### QUALITÉ

- Conforme à la norme **CE** et à la directive européenne 2006/42/CE.
- Examen de conformité réalisé par SOCOTEC.
- Montage et contrôle unitaire avant expédition
- Contrôles et tests de charges effectués par notre service qualité.

### SPÉCIAL CHARGES LOURDES

- Charge utile de 80 kg
- Chassis renforcé. Colonnes en profilé aluminium lourd guidées par patins polyamide.

### PERFORMANT ET RÉSISTANT

- Hauteur de pose plaque horizontale : 4,10 m ou 4,50 m avec la rallonge de 0,40 m (livrée en option)
- Hauteur de chargement : 0,69 m
- Charge maximum : 80 kg.

### CARACTÉRISTIQUES

- Ouverture maximum des bras de bout : 3,10 m
- Equipé d'un poignée de basculement (breveté)
- 3 roues équipées d'un système de blocage
- Empattement réduit pour franchir les portes : 1,02 x 1,02 m
- Poids de l'appareil : 53 kg
- Peinture époxy.

## LEVPANO MASTER®

Pose horizontale et sous rampants - spécial charges lourdes.

Hauteur de pose m	Hauteur de chargement m	Hauteur plateforme m	Charge maximum kg	kg	Ref.	📦
4,10	0,69	0,49	80	53	516000	1

Kit de rechange 2 câbles		Ref.
A embout		PR0211
Rallonge m	Ref.	📦
0,40	516512	1



16



62



96



120



126



156



188



224



248



254



300



316



340



390



462



488

# PLAQUISTE : LEVPANO COMBI®

## LEVPANOcombi® USAGE INTENSIF LE HAUT DE GAMME ROBUSTE, POLYVALENT ET MANIABLE

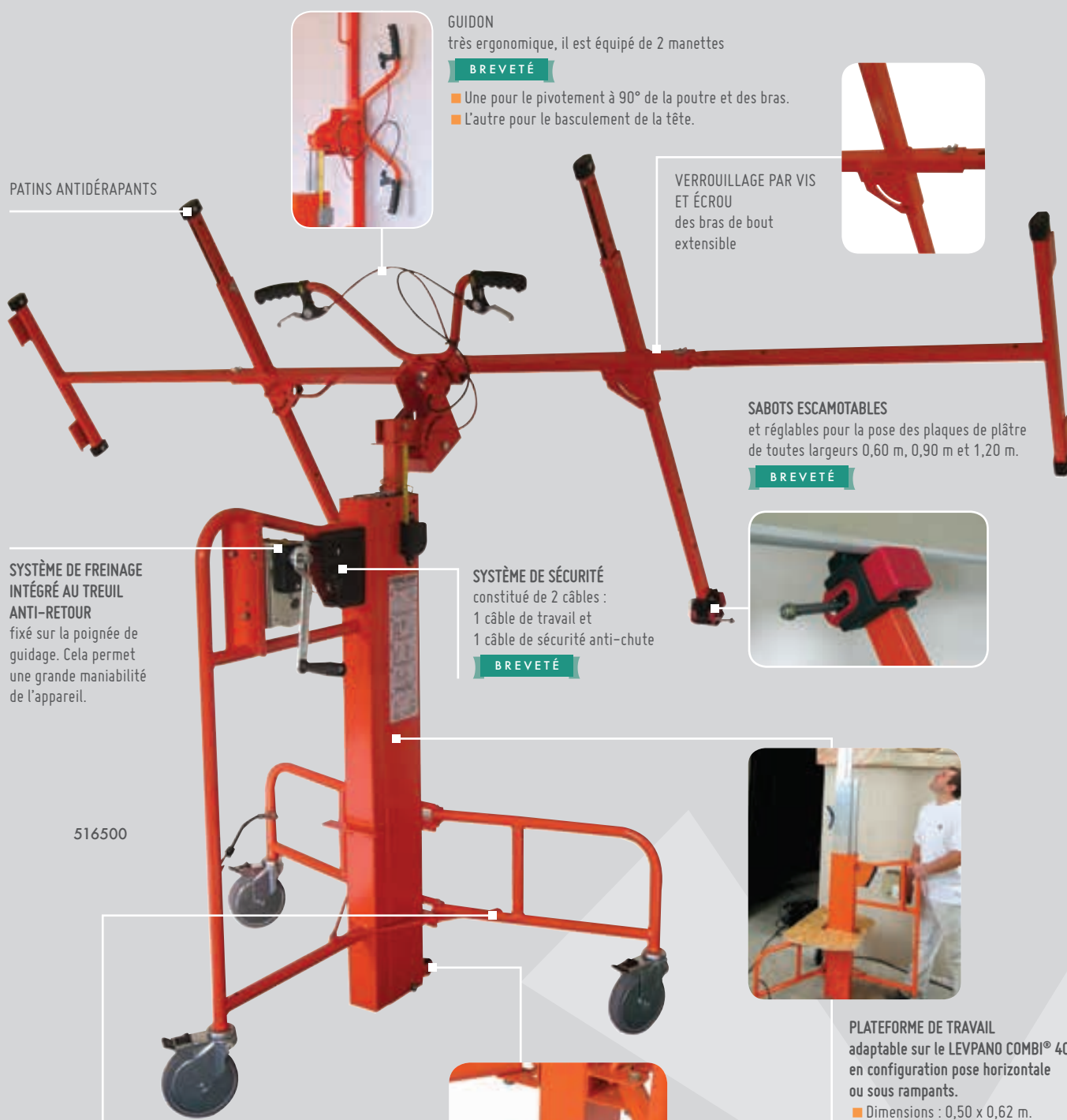

**GUIDON**  
très ergonomique, il est équipé de 2 manettes

**BREVÉTÉ**

- Une pour le pivotement à 90° de la poutre et des bras.
- L'autre pour le basculement de la tête.

PATINS ANTIDÉRAPANTS

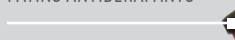

**SYSTÈME DE FREINAGE INTÉGRÉ AU TREUIL ANTI-RETOUR**  
fixé sur la poignée de guidage. Cela permet une grande maniabilité de l'appareil.

516500

**SYSTÈME DE SÉCURITÉ**  
constitué de 2 câbles :  
1 câble de travail et  
1 câble de sécurité anti-chute

**BREVÉTÉ**



**VERROUILLAGE PAR VIS ET ÉCROU**  
des bras de bout extensible

**SABOTS ESCAMOTABLES**  
et réglables pour la pose des plaques de plâtre de toutes largeurs 0,60 m, 0,90 m et 1,20 m.

**BREVÉTÉ**



**PLATEFORME DE TRAVAIL**  
adaptable sur le LEVPANO COMBI® 400 et 450 en configuration pose horizontale ou sous rampants.

- Dimensions : 0,50 x 0,62 m.
- Epaisseur : 25 mm.
- Hauteur : 0,49 m.
- Résistance : 150 kg.

Cette plateforme est livrée avec l'appareil



**EMPATTEMENT**

Pose horizontale et sous rampants : 1,02 x 1,02 x 1,02 m.  
Pose verticale : 1,09 x 0,94 x 0,94 m.



**2 ROULETTES**

fixées à la base de la colonne facilitent le transport.



**3 éléments :**

- Tête, colonne et piètement
- Bras
- Plateforme

# PLAQUISTE : LEVPANO COMBI®



## + LES PLUS

- L'innovation technique pour combiner 2 solutions :
  - la pose des plaques de plâtre dans toutes les configurations : verticale, horizontale et sous rampants
  - la pose des plaques de plâtre de toutes largeurs : 0,60 m, 0,90 m et 1,20 m grâce aux sabots escamotables et réglables sur le bras du LEVPANO COMBI® (breveté) et grâce aux bras réglables opposés aux sabots
- Pose horizontale jusqu' à 4 m et à la verticale jusqu' à 5,40 m ou 5,90 m avec le LEVPANO COMBI® 450
- Colonnes aluminium permettant une charge utile de 80 kg
- 3 roues Ø 160 mm facilitant les déplacements sur sol brut en particulier avec des plaques coupe-feu ou plaques de gypse et de cellulose plus lourdes
- Montage / Démontage rapide



Chargement d'une plaque de 1,20 m x 2,50 m en vue d'une pose sous rampants.



Chargement d'une plaque de 1,20 m x 2,50 m en vue d'une pose horizontale.



Chargement d'une plaque de 1,20 m x 2,50 m en vue d'une pose verticale.



### SÛR

- Système de sécurité breveté constitué de deux câbles :
  - 1 câble de travail
  - 1 câble de sécurité anti-chute

### MANIABLE

- Système de freinage intégré au treuil anti-retour fixé sur la poignée de guidage.
- Empattement réduit réglable pour franchir les portes : 1,02 x 1,02 x 1,02 m (pose horizontale et sous rampants) et 1,09 x 0,94 x 0,94 m (pose verticale).

### QUALITÉ

- Montage et contrôle unitaire avant expédition
- Contrôles et tests de charges effectués par notre service qualité.
- Conforme à la norme **CE** et à la directive européenne 2006/42/CE.
- Examen de conformité réalisé par SOCOTEC.

### CARACTÉRISTIQUES

- Ouverture maximum des bras de bout : 3,10 m
- Bras équipés de 2 sabots escamotables et de 8 patins anti-dérappants.
- 3 roues équipées d'un système de blocage.
- Hauteur minimale de la plaque horizontale : 1,19 m = plan de travail
- Charge utile : 80 kg
- Plateforme de travail dimension : 0,50 x 0,62 m épaisseur : 25 mm - hauteur : 0,49 m - résistance : 150 kg
- Peinture époxy.

## LEVPANO COMBI® 400

Pose horizontale, jusqu'à 4 m et pose sous rampants et verticale jusqu' à 5,40 m



Hauteur de pose horizontale m	Hauteur de pose verticale m	Hauteur de chargement m	Hauteur plateforme m	Charge utile kg	kg	Ref.	📦
4	5,40	0,68	0,49	80	53	516500	1
Kit de rechange 2 câbles			Ref.	📦			
A boucle			PRO296	1			
A embout			PRO199	1			

## LEVPANO COMBI® 450

Pose horizontale jusqu'à 4,5 m et pose sous rampants et verticale jusqu'à 5,90 m



Hauteur de pose horizontale m	Hauteur de pose verticale m	Hauteur de chargement m	Hauteur plateforme m	Charge utile kg	kg	Ref.	📦
4,50	5,90	0,81	0,49	80	55	517000	1
Kit de rechange 2 câbles			Ref.	📦			
A embout			PRO211	1			



16



62



96



120



126



156



188



224



248



254



300



316



340



390



462



488



491



491



# DÉROULEUR PARE-VAPEUR

## DÉROULEUR PARE-VAPEUR



### + LES PLUS

MONTAGE SUR LA GAMME LEVPANO®

- Adaptation facile et rapide sur le châssis des LEVPANO® I et II, LEVPANO COMBI® et MASTER® grâce aux 3 adaptateurs livrés avec le dérouleur :
  - Un adaptateur pour l'ancienne génération de LEVPANO® I et II sans rallonge intégrée
  - Un adaptateur pour les LEVPANO COMBI® et MASTER®
  - Un adaptateur pour les appareils à colonne de 30 mm
- Gain de temps et pénibilité réduite pour le poseur (prévention des T.M.S.).



### UTILISATION

- Facilite la pose du film pare-vapeur (exigences RT 2012 Maisons BBC – étanchéité à l'air) :
  - Au plafond et au mur
  - Sur les armatures métalliques et les ossatures bois
  - Avant la pose de la plaque de plâtre ou de tous panneaux bois, lambris, etc...
- Facilite la pose de la toile de verre et des tissés à peindre, en rouleau de 1 m et 1,06 m grâce aux flasques réglables. Pour rouleaux de largeur 1,50 m maximum.

Flasques réglables :

- 1,50 m centré
- 1 m et 1,06 m centré
- 1 m et 1,06 m déporté.
- Charge maximum : 30 kg.



### CARACTÉRISTIQUES

- Conforme à la norme **CE**
- Conforme à la directive européenne 2006/42/CE.
- Examen de conformité réalisé par SOCOTEC.
- En tube acier, finition époxy.



## DÉROULEUR DE FILM PARE-VAPEUR

Adaptable sur la gamme LEVPANO®.



Largeur maxi rouleau	Charge maximum kg	kg	Ref.	
1,50	30	7,8	513300	1

## PLATEFORME ACCESSOIRE DE LEVAGE



### + LES PLUS

- Adaptation facile et rapide sur le châssis des LEVPANO® I et II, LEVPANO COMBI® et MASTER® grâce aux 3 adaptateurs livrés avec la plateforme :
  - Un adaptateur pour l'ancienne génération de LEVPANO® I et II sans rallonge intégrée
  - Un adaptateur pour le LEVPANO MASTER® et le LEVPANO COMBI®
  - Un adaptateur pour les appareils à colonne de 30 mm
- Équipée de 4 passages de sangle pour immobiliser la charge sur le plateau (Sangle à cliquet 5 m x 25 mm réf : 825000)
- Gain de temps et pénibilité réduite pour le poseur (prévention des T.M.S.).

### UTILISATION

- Permet l'élévation, la manutention, le maintien en hauteur de tout élément à fixer : gaines, aérothermes, téléviseurs...

### CARACTÉRISTIQUES

- Conforme à la norme **CE**
- Conforme à la directive européenne 2006/42/CE.
- Examen de conformité réalisé par SOCOTEC.
- En contreplaqué antidérapant 9 mm et en tube acier peint, épaisseur : 2 mm
- Dimensions du plateau : 495 x 505 mm.
- Charge maximum : 65 kg avec charge centrée par rapport au mât du LEVPANO®.
- Légère : 4,5 kg.



## PLATEFORME ACCESSOIRE DE LEVAGE

Adaptable sur la gamme LEVPANO®



Dimensions mm	Charge maximum kg	kg	Ref.	☐
495 x 505	65	4,5	513200	1

## ÉTAI 3<sup>ÈME</sup> MAIN

### + LES PLUS

- Fonction 3<sup>ème</sup> main
- Réglage précis et rapide
- Équipé d'un verrou de sécurité pour une sécurisation optimale

### CARACTÉRISTIQUES

- Charge admissible :  
80 kg à 90° et 30 kg à 55°.

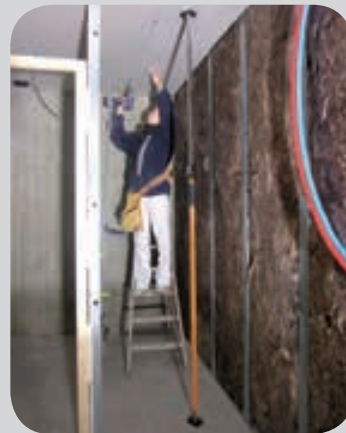

## ÉTAI 3<sup>ÈME</sup> MAIN

Pour un réglage précis et rapide. Equipé d'un verrou de sécurité pour une sécurisation optimale.

Extensible m	Ref.	☐
0,75 -> 1,25	504800	1
1,60 -> 2,90	504810	1



16



62



96



120



126



156



188



224



248



254



300



316



340



390



462



488



## CHARIOT PORTE-PLAQUES

### + LES PLUS

- Lutte contre les maladies professionnelles
- Très pratique sur les chantiers
- 2 poignées orientables et télescopiques de 1,40 m à 2,00 m
- Robuste, haute qualité.



### UTILISATION

- Adapté pour le transport des plaques de plâtre, panneaux de bois...

### CARACTÉRISTIQUES

- Peinture époxy
- 2 roues caoutchouc
- Charge maximum 900 kg
- Conforme **CE** et à la directive Européenne 2006/42/CE.



500550



### CHARIOT PORTE-PLAQUES 2 ROUES 900 KG

Conforme **CE** et à la directive Européenne 2006/42/CE.  
2 poignées orientables et télescopiques de 1,40 m à 2,00 m.



### CHARIOT PORTE-PLAQUES 2 ROUES 450 KG

Conforme **CE** et à la directive Européenne 2006/42/CE.  
Revêtement caoutchouc à la base pour protéger les matériaux transportés.  
2 poignées plastiques.



Dimensions du support cm	Charge maximum kg	⚖️ kg	Ref.	📦
80 x 21	900	13	500550	1

Dimensions du support cm	Charge maximum kg	⚖️ kg	Ref.	📦
21 x 60	450	11,5	500540	1



## CHARIOT PORTE-PLAQUES PLIABLE 4 ROUES



### + LES PLUS

- Lutte contre les maladies professionnelles
- Très pratique : pliable
- Robuste, haute qualité
- 4 roues caoutchouc dont 2 équipées d'un système de blocage du pivot et du roulage.
- Grande stabilité.

### CARACTÉRISTIQUES

- Peinture époxy
- Charge 450 kg pour la réf. 500570, et 900 kg pour la réf. 500560
- Conforme **CE** et à la directive Européenne 2006/42/CE.



chariot plié



## CHARIOT PORTE-PLAQUES 4 ROUES

Conforme **CE** et à la directive Européenne 2006/42/CE.  
Peinture époxy. 4 roues caoutchouc dont 2 équipées d'un système de blocage du pivot et du roulage.



16



62



96



120



126



156



188



224



248



254



300



316



340



390



462



488



405

Dimensions du support cm	Charge maximum kg	▲ kg	Ref.	☐
83 x 32	900	24,5	500560	1
83 x 32	450	21	500570	1



# PLAQUISTE : TRANSPORTEUR

## TRANSPORTEUR DE PLAQUES À TIGE

### PRATIQUE

- Pour le transport de plaques de plâtre et de tous types de panneaux, par 1 seule personne
- Outil indispensable, très pratique
- Gain de temps sur le chantier
- Excellente prise en main, poignée ergonomique.



## TRANSPORTEUR DE PLAQUES À TIGE

Transport par 1 personne.  
Poignée ergonomique.



L cm	Ref.	
42	502120	1
62	502110	1

## TRANSPORTEUR DE PLAQUES À GRIFFES

### UTILISATION

- Pour le transport des plaques de plâtres et de tous types de panneaux, par 2 personnes
- Le poids de la plaque de plâtre transportée provoque un auto-serrage qui évite le glissement de la plaque
- Excellente prise en main.



## TRANSPORTEURS DE PLAQUES À GRIFFES

Pour le transport des plaques par 2 personnes, par auto-serrage de la plaque. La paire.



Passage entre 2 griffes cm	Ref.	
4	502100	1





## TRACE-ESCALIER

### + LES PLUS

- Report direct des dimensions de marches sans mesure ni règle
- Plus rapide
- Moins de risque de se tromper



### UTILISATION

- Les escaliers intérieurs de logement individuel ont des dimensions normalisées mais variables : hauteur de marches entre 17 et 21 cm et giron de marche (profondeur) entre 21 et 27 cm. D'autre part, il existe des souvent irrégularités dans les marches. Il est assez ainsi fastidieux de reporter chaque marche sur la plaque.
- Le trace-escalier permet de copier fidèlement et reporter directement le profil des marches d'escalier. Plus besoin de moyen de mesure ni de règle.
- Il permet de reporter 4 marches à chaque fois.

### MODE D'EMPLOI

- 1 - apposer le trace-escalier sur les marches
- 2 - bloquer les vis papillon dans les lumières à l'intérieur de chaque branche
- 3 - apposer-le sur le support à découper (plaques de plâtre en particulier)
- 4- tracer et découper selon traçage

### CARACTÉRISTIQUES

- Constitué de 9 branches articulées
- Matériau : en plastique ABS
- Longueur de chaque branche : 36 cm
- Pour marche de 12 x 12 cm à 32,5 x 32,5 cm

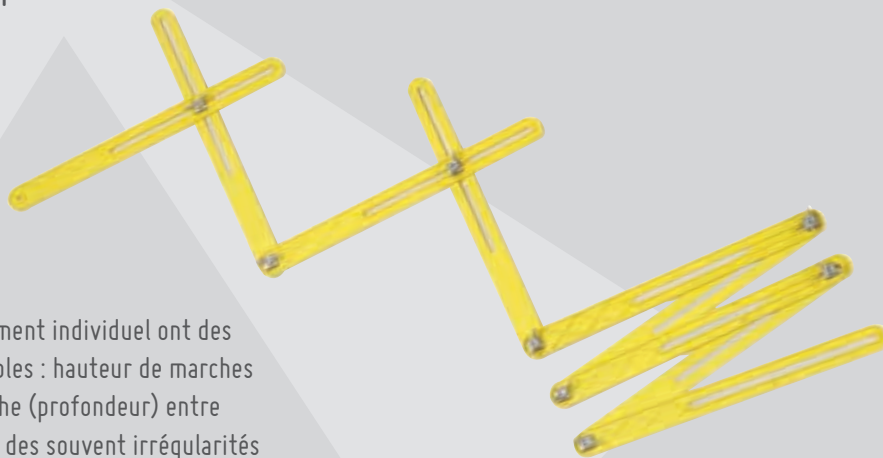

## TRACE-ESCALIER

9 branches, ABS.

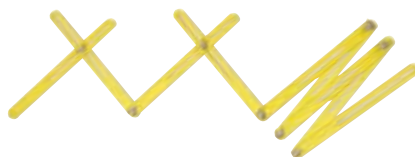

Cavalier de suspension

Nb branches  
9

Ref.  
502170

1



16



62



96



120



126



156



188



224



248



254



300



316



340



390



462



488

# PLAQUISTE : RÈGLE EXTENSIBLE

## RÈGLE EXTENSIBLE POSE-FOURRURES

### + LES PLUS

- Profil aluminium
- Rapidité de pose
- Régularité des intervalles entre les fourrures
- Planéité parfaite



### UTILISATION

- Ces règles peuvent être suspendues à l'aide de crosses sur des solivages ou fermettes ou supportées à l'aide de "pied de poule" (réf 501050) pour pose sous hourdis ou dalle béton.
- Le bord supérieur de la règle correspond à la hauteur du plafond fini.
- A utiliser en général par jeu de trois règles.

### CARACTÉRISTIQUES

- Graduation de 10 cm en 10 cm, pour réglage à intervalles réguliers des taquets pour recevoir des fourrures de 5 cm
- Livrée avec le nombre de taquets prévus pour intervalles de 40 cm entre les fourrures.



## RÈGLE EXTENSIBLE POSE-FOURRURES

Profil aluminium.  
Graduation. Fourrures de 5 cm. Livrée avec taquets.



Dim. fermée m	Dim. ouverte m	Nb taquets	Ref.	☐
2	3,70	10	501200	1
2,50	4,70	15	501250	1
3	5,70	15	501300	1
3,50	6,70	20	501350	1
4	7,70	20	501400	1
Taquets de rechange			Ref.	☐
5			501550	5

## PIED DE POULE ALUMINIUM



### UTILISATION

- Pour supporter les règles (sous hourdis ou dalles en béton par exemple)
- Hauteur minimum repliée : 1,20 m
- Hauteur standard déployée : 3,30 m.

### CARACTÉRISTIQUES

- Equipé d'un système porte-niveaux à eau
- Réglage millimétrique facilité par un système de molette ergonomique
- Pieds repliables
- Avec papillon de blocage de la règle.



Ensemble pied de poule aluminium, règle pose-fourrures, niveau à eau. Le réglage de l'horizontalité de la règle pose fourrures s'effectue à l'aide des 2 fioles graduées du niveau à eau

- On amène le liquide sur la même valeur de la graduation des 2 fioles grâce au réglage millimétrique des pieds de poule aluminium
- Ce réglage millimétrique s'effectue en tournant la molette plastique située sous le papillon de blocage de la bague de maintien de la colonne intermédiaire.

## PIED DE POULE ALUMINIUM

Pied de poule aluminium.  
Porte-niveaux à eau. Réglage millimétrique avec molette.  
Pieds repliables. Avec papillon de blocage de la règle.



Hauteur m	Ref.	☐
1,20 > 3,30	501050	1



## CROSSE SUPPORT DE RÈGLE

Longueur : 50 cm.  
Dispositif de serrage en matière de synthèse.  
Réglage du serrage : de 0 à 43 mm.



	Ref.	📦
A plaquette pour fermettes	501700	3
A pointe pour plafonds	501720	3
A vis pour plafonds	501710	3

## COFFRET NIVEAU À EAU

Présentation sous coffret plastique. 2 fioles graduées sur 10 cm, Avec bouchon d'évacuation d'air. Livré avec 20 m de tuyau 9 x 12 mm.



Ref.	📦
501100	1

## RÈGLE REPORT DE TRACÉ



### UTILISATION

- Pour le traçage et l'implantation des cloisons.
- Cette règle extensible avec niveaux verticaux permet le report simple et rapide du tracé du sol au plafond par une seule personne.
- A l'extrémité supérieure de la règle peuvent s'adapter deux platines amovibles, une pour un report de tracé normal, l'autre pour un report décalé.
- Le pied muni d'un ressort, et un papillon de blocage permettent de fixer la règle entre sol et plafond.
- Dans le cas de cloison alvéolée, utiliser la platine déportée de 10 ou 13 mm selon l'épaisseur de la plaque de parement (voir schéma).
- Une oreille permettant d'accrocher un cordeau-traceur facilite le traçage par une seule personne.

### CARACTÉRISTIQUES

- Profil aluminium
- Hauteur maximum : 3,10 m
- Hauteur minimum : 1,75 m
- Poids : 3,55 kg
- Livré avec étui.



platine pour report de tracé décalé 10 mm - 13 mm

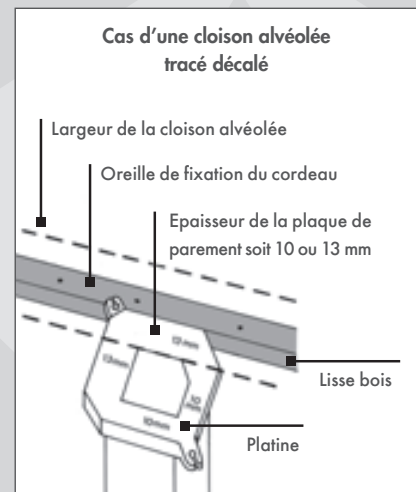
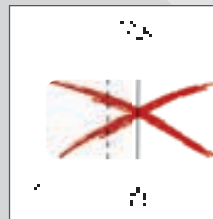

## RÈGLE REPORT DE TRACÉ

Profil aluminium.  
Hauteur maximum : 3,10 m. Hauteur minimum : 1,75 m.  
Poids : 3,55 kg. Livré avec étui.

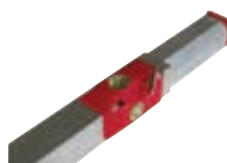

Hauteur cm	📦	kg	Ref.	📦
1,75 > 3,10	3,55		501600	1



# PLAQUISTE : PINCES

## CISAILLE À TÔLE TYPE AVIATION

Adaptée à la découpe des profils. La forme des becs permet une coupe à droite, à gauche ou droite. Manche bi-matière toucher "Soft".



g	Ref.	cube
425	503328	1

## CISAILLE À TÔLE TÊTE DÉPORTÉE

Pour la découpe des profils. Tête déportée des branches, ce qui permet un passage de la main par rapport au plan de coupe.



g	Ref.	cube	Ref.	cube
540	503310	1	503318	1

## CISAILLE À TÔLE

Adaptée à la découpe des profils. La forme des becs permet une coupe passe-tôle et circulaire.



g	Ref.	cube	Ref.	cube
562	503300	1	503308	1

## PINCE À CHEVILLES

Pour fixation dans des matériaux creux. Pour toutes marques de chevilles métalliques à expansion, de toutes longueurs et diamètres. Manche bi-matière toucher "Soft".



g	Ref.	cube
590	503018	1

## CISAILLE GRIGNOTEUSE

### UTILISATION

- Coupe-copeau intégré et protection contre les projections de copeau
- Pour découper le métal jusqu'à 1,2 mm d'épaisseur
- Coupe circulaire avec un radius de 25 mm.

### QUALITÉ

- Bordures propres sans arête
- Coupe sans distorsion
- Poignée bi-matière toucher "Soft".



## PINCE À AGRAFAGE UNIVERSEL

### UTILISATION

- Agrafage universel pour rail, montant, lisse et fourrure
- Tête effilée pour un meilleur accès

### CARACTÉRISTIQUES

- Poignée bi-matière toucher "Soft"
- Capacité maximum : 1,0 mm + 1,0 mm
- Longueur : 33 cm.



## CISAILLE GRIGNOTEUSE AVEC COUPE-COPEAU INTÈGRE



L cm	g	Ref.	cube
26	540	503108	1
Lame de rechange		Ref.	cube
x 1		503110	1

## PINCE À AGRAFAGE UNIVERSEL



L cm	Capacité de coupe mm	g	Ref.	cube
33	1,0 + 1,0	800	503378	1



## PINCE À AGRAFAGE DES PROFILÉS

### UTILISATION

- Permet un agrafage rapide et solide des profilés par poinçonnage
- Bras largement dimensionnés réduisant l'effort de pression
- Utilisation à 2 mains
- Sertissage rapide et efficace pour la fixation des rails
- Pas besoin de vis ni de goujons.



### CARACTÉRISTIQUES

- Manche bi-matière toucher "Soft"
- Capacité maximum : 0,8 + 0,8 mm
- Longueur : 34 cm.

## PINCE À AGRAFAGE DES PROFILÉS



L cm	Capacité de coupe mm	g	Ref.	Blister
34	0,8 + 0,8	970	503208	1

## PINCE À AGRAFAGE DES MAXI PROFILÉS

### UTILISATION

- Permet un agrafage à une main rapide et solide des profilés par poinçonnage.
- Bras largement dimensionnés réduisant l'effort de pression.
- Utilisation à deux mains
- Evite l'écrasement de certains types de fourrures grâce au dégagement important de la matrice.

### CARACTÉRISTIQUES

- Poignée bi-matière toucher "Soft"
- Capacité maximum : 0,8 mm + 0,8 mm
- Longueur : 35,5 cm.



## PINCE À AGRAFAGE DES MAXI PROFILÉS



L cm	Capacité de coupe mm	g	Ref.	Blister
35,5	0,8 + 0,8	950	503368	1

## PINCE À AGRAFAGE DES PROFILÉS À UNE MAIN

### UTILISATION

- Permet un agrafage rapide et solide des profilés par poinçonnage
- Grande aisance de travail grâce à son système de poignée démultipliée
- Utilisation à une main

### CARACTÉRISTIQUES

- Manche bi-matière toucher "Soft"
- Capacité maximum 0,6 mm + 0,6 mm
- Longueur : 27 cm



## PINCE À AGRAFAGE DES PROFILÉS, À UNE MAIN



L cm	Capacité de coupe mm	g	Ref.	Blister
27	0,6 + 0,6	740	503348	1

## PINCE À AGRAFAGE DES MAXI PROFILÉS À UNE MAIN

### UTILISATION

- Permet un agrafage à une main rapide et solide des maxi profilés par poinçonnage.
- Evite l'écrasement de certains types de fourrures grâce au dégagement important de la matrice.

### CARACTÉRISTIQUES

- Poignée bi-matière toucher "Soft"
- Capacité maximum : 0,6 mm + 0,6 mm
- Longueur : 29,5 cm.

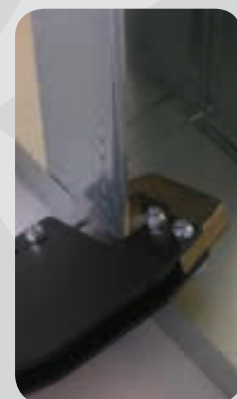

## PINCE À AGRAFAGE DES MAXI PROFILÉS À UNE MAIN



L cm	Capacité de coupe mm	g	Ref.	Blister
29,5	0,6 + 0,6	780	503338	1



16



62



96



120



126



156



188



224



248



254



300



316



340



390



462



488

## PINCE À AGRAFAGE DES PROFILS DOS À DOS

### UTILISATION

- Spécial sertissage montants dos à dos (idéal pour une hauteur de plafond supérieure à 2,50 m)
- Bras largement dimensionnés réduisant l'effort de pression.

### CARACTÉRISTIQUES

- Manche bi-matière toucher "Soft"
- Longueur 56 cm



## PINCE À AGRAFAGE DES PROFILS DOS À DOS



L cm	kg	Ref.	
56	1,30	503380	1

## STRIPANO®



### + LES PLUS

- Striage du complexe en position debout, sans se baisser : lutte contre les maladies professionnelles
- Lame entièrement protégée : lutte contre les accidents, outil sécurisé
- Lame interchangeable (réf : 502218)
- Pratique et ergonomique.

TMS

striPANO®

### UTILISATION

- Pour le striage du complexe en position debout, pour éviter le gavage
- Profondeur de coupe de l'isolant réglable de 20 à 140 mm, de 10 en 10 mm.

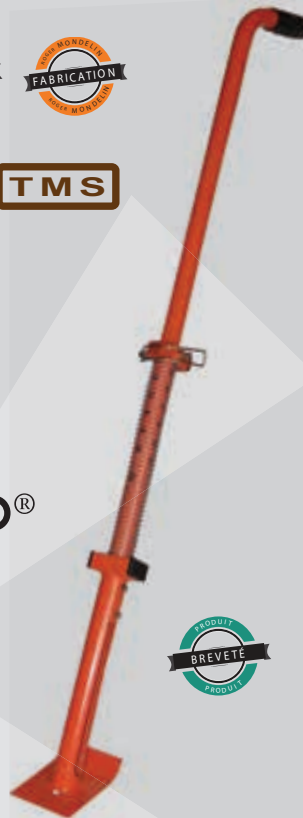

## STRIPANO®

Striage de l'isolant des complexes.

Profondeur de coupe mm	Ref.	
20 > 140	502200	1
Carte de 2		
Lames de rechange	Ref.	
x 2	502218	1





## COUPEAU POUR MATÉRIAUX D'ISOLATION

### UTILISATION

- Pour la coupe de la laine de verre, laine de roche, laine de mouton, chanvre, lin, polystyrène et fibres bois.

### CARACTÉRISTIQUES

- Lame inoxydable avec double coupe :
  - Denture en scie pour matériaux durs
  - Denture en vague pour matériaux souples
- Dureté : 56/58 HRC
- Avec étui de suspension.

### GAMME COMPLÈTE

- 3 types de manches :
  - Manche plastique = 28 et 36 cm
  - Manche bois = 28, 36 et 48 cm
  - Manche bi-matière toucher "Soft" = 28 cm



### COUPEAU POUR MATÉRIAUX D'ISOLATION MANCHE BOIS

Bois naturel. Lame inox.  
Double denture.  
Avec étui de suspension.



L cm	Ref.	📦
28	830580	1
36	830583	1
48	830586	1

### COUPEAU POUR MATÉRIAUX D'ISOLATION MANCHE BI-MATIÈRE

Manche bi-matière  
toucher "Soft". Lame inox.  
Double denture.  
Avec étui de suspension.



L cm	Ref.	📦
28	830589	1

### COUPEAU POUR MATÉRIAUX D'ISOLATION MANCHE PLASTIQUE

Manche polypropylène.  
Lame inox. Double  
denture. Avec étui de  
suspension.



L cm	Ref.	📦
28	830581	1
36	830584	1

### ÉTUI COUPEAU POUR MATÉRIAUX D'ISOLATION

Fourreau synthétique.



Pour coupeau longueur cm	Ref.	📦
28	830582	1
36	830585	1
48	830588	1



16



62



96



120



126



156



188



224



248



254



300



316



340



390



462



488



413

# PLAQUISTE : TRAVAILLER LA PLAQUE

## ÉTABLI DE PLAQUISTE



### UTILISATION

- Permet de travailler aisément sur des plaques de plâtre de toutes dimensions grâce aux 2 traverses intermédiaires, réglables et escamotables.

### CARACTÉRISTIQUES

- Hauteur : 80 cm.
- Résistance : 1500 kg (charge uniformément répartie sur les chevrons).
- Livré avec 2 chevrons de 2 m et 2 traverses intermédiaires de 70 cm.
- Peinture époxy



## ÉTABLI DE PLAQUISTE

Livré avec 2 chevrons de 2 m et 2 traverses intermédiaires de 70 cm.



éta bli dé monté

H cm	Ref.	📦
80	500520	1

## CUTTER DE PLAQUISTE 25 MM

1 lame renforcée épaisseur : 0,7 mm.  
Verrouillage par vis. Blocage automatique de la lame par molette de sécurité sur le guide métal. Manche bi-matière.



Épaisseur mm	Ref.	📦
0,7	103098	1

## EQUERRE ALUMINIUM À TALON AVEC ECHARPE



Dimension cm	Ref.	📦
60 x 120	350052	1

## FAUSSE ÉQUERRE ALUMINIUM À TALON

Avec vis de blocage.



Dimension cm	Ref.	📦
50	350262	1

## FAUSSE ÉQUERRE ALUMINIUM

Avec vis de blocage.



Dimensions cm	Ref.	📦
50	350250	1

## BOÎTE DE 10 LAMES CUTTER 25 MM

Épaisseur 0,7 mm.  
Pour cutters réf. 103098.  
Dimensions : 10 x 25 mm.  
Avec trou de suspension.



Nb de pièces x 10	Épaisseur mm	Ref.	📦
	0,7	103198	1

## CUTTER DE PLAQUISTE 25 MM TAJIMA®

Manche en aluminium, robuste et de haute qualité.  
Avec molette de blocage.  
Épaisseur : 0,7 mm.  
Livré avec 2 lames.



Épaisseur mm	Ref.	📦
0,7	103518	1

## BOÎTE DE 10 LAMES TAJIMA® CUTTER 25 MM

Lames de rechange pour cutter TAJIMA®.  
Boîte de 10 lames pour réf. 103518.



Nb de pièces x 10	Ref.	📦
	103538	1

>> Voir tous nos cutters **chapitre Sciage-coupe**



# PLAQUISTE : DÉCOUPER LA PLAQUE



## TÉ DE PLAQUISTE

### + LES PLUS

- Règle rigide millimétrée
- Outil robuste en acier 15/10<sup>ème</sup>
- Gravure laser indélébile
- Prêt à l'emploi : livré avec un crayon de charpentier.

### UTILISATION

- Permet de réaliser des coupes de 10 à 600 mm dans la plaque de plâtre avec un cutter traditionnel.
- Permet de réaliser des tracés de 10 à 600 mm sur la plaque de plâtre.



## TÉ DE PLAQUISTE

Coupes et tracés de 10 à 600 mm.  
Livré avec un crayon de charpentier.

Largeur de coupe cm	Ref.	📦
1 > 60	502660	1



## GRAND TRUSQUIN DE PLAQUISTE

### + LES PLUS

- Graduation pour mesure de coupe
- Gravure laser indélébile pour une longévité accrue
- Outil pouvant servir d'équerre
- Lame rétractable pour un transport en toute sécurité et pendant le traçage avec le crayon
- Poignée ergonomique qui assure un meilleur confort de travail
- Outil utilisable par les gauchers et les droitiers

### UTILISATION

- Permet de réaliser des coupes et des tracés jusqu'à 60 cm dans la plaque de plâtre.

### COMPLET

- Outil composé de 3 parties :
  - 1 guide muni d'une poignée ergonomique
  - 1 réglet gradué
  - 1 porte-lames et 1 porte-crayon mobiles sur le réglet
- Livré avec 5 lames trapèze de rechange (réf : 502638) et un crayon.



## GRAND TRUSQUIN DE PLAQUISTE

Coupes et tracés jusqu'à 60 cm. 5 lames trapèze de rechange.

Largeur de coupe cm	Ref.	📦
> 60	502160	2



16



62



96



120



126



156



188



224



248



254



300



316



340



390



462



488

# PLAQUISTE : DÉCOUPER LA PLAQUE

## TRUSQUIN DE PLAQUISTE



### + LES PLUS

- Équipé de 2 lames réglables
- Graduation pour mesure de la coupe
- Utilisation : permet des coupes jusqu'à 10 cm de large dans les plaques de plâtre.



## RABOT À CHANFREINER



### + LES PLUS

- Pour chanfreiner les chants des plaques de plâtre
- Permet de faire un chanfrein de 7 mm
- Léger et ergonomique



## TRUSQUIN DE PLAQUISTE

Coupes jusqu'à 10 cm de large.  
Brochable.



Largeur de coupe cm	Ref.	
> 10	502650	1

## RABOT À CHANFREINER

Chanfrein de 7 mm. Lame interchangeable 502638.



Ref.		Lames de rechange
502600	1	502638

## 5 LAMES TRAPÈZE POUR TRUSQUINS ET RABOT À CHANFREINER

Carte de 5 lames trapèze pour trusquins et rabots à chanfreiner.



Nb de pièces	Ref.	
x 5	502638	1

# PLAQUISTE : RABOTER LA PLAQUE



## RABOT-RÂPE PLASTIQUE



### + LES PLUS

- Très bonne tenue en main grâce à l'ergonomie de la poignée
- Lame interchangeable de 255 mm
- Ergonomie adaptée aux rabotages et des chants de plaques de plâtre.

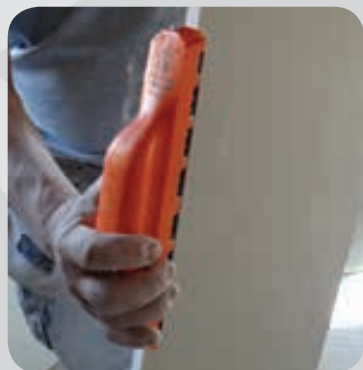

### RABOT-RÂPE PLASTIQUE

Ergonomie adaptée pour le rabotage des chants des plaques de plâtre. Lame interchangeable de 255 mm.



L lame mm	Ref.	📦
255	502530	1

### RABOT-RÂPE MÉTALLIQUE

Pour raboter les chants des plaques de plâtre. Lame interchangeable de 255 mm.



L lame mm	Ref.	📦	Ref.	📦
255	502500	1	502508	1

### LAME DE RECHANGE POUR RABOT-RÂPE

Pour Réf. 502500 et 502530.

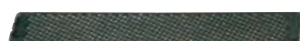

L lame mm	Ref.	📦	📄 Carte de 1		📄 Carte de 2	
			Ref.	📦	Ref.	📦
255	502510	1	502529	1	502528	1

## RABOT-RÂPE DE POCHE



### + LES PLUS

- Format poche compact
- Ouvertures latérales pour l'évacuation du plâtre
- Ergonomique pour raboter les chants de plaques de plâtre
- Corps plastique léger 49g
- Lame interchangeable de 140 mm
- Remplacement par vissage



### RABOT-RÂPE DE POCHE

Pour raboter les chants de plaques de plâtre. Lame interchangeable ci-dessous.



L lame mm	Ref.	📦
140	502560	1

### RABOT-RÂPE DE POCHE

Pour raboter les chants de plaques de plâtre. Lame interchangeable ci-dessous. Prévu pour être remplacé par 502560.



L lame mm	Ref.	📦	📄 Carte de 1		📄 Carte de 2	
			Ref.	📦	Ref.	📦
140	502540	1	502548	1		

### LAME DE RECHANGE POUR RABOT-RÂPE DE POCHE

Pour Réf. 502540 et 502560.



L lame mm	Ref.	📦	📄 Carte de 1		📄 Carte de 2	
			Ref.	📦	Ref.	📦
140	502550	1	502559	1	502558	1



16



62



96



120



126



156



188



224



248



254



300



316



340



390



462



488



488



417



# PLAQUISTE : CALER LA PLAQUE

## CALE-PLAQUE À LEVIER

### + LES PLUS

- Permet de caler la plaque de plâtre sur l'ossature métallique
- Facilite la fixation de la plaque par une seule personne
- Outil pratique et indispensable

### NOUVEAU DESIGN

- Largeur d'appui optimisée pour préserver la plaque

### CARACTÉRISTIQUES

- Hauteur 80 cm
- Sabot et tige en acier
- Peinture époxy
- Cale mobile en plastique.

Fabrication : Produits accrochés sur convoyeur en attente de l'opération de peinture



## CALE-PLAQUE À LEVIER

Permet de caler la plaque de plâtre sur l'ossature métallique.



Hauteur cm	kg	Ref.	☐
80	1,45	502050	1

## LEVIER À PANNEAUX À ROULEAU

Corps en acier. Bride rigide en acier peint. Muni d'un rouleau facilitant l'ajustement de la plaque sur la structure métallique.



Ref.	☐
502000	1

## LEVIER À PANNEAUX À BASCULE ET À DÉGONDER LES PORTES

Corps en acier. Bride rigide en acier peint.



Ref.	☐
502010	1



## EMBOUT PH2 PLAQUISTE



### + LES PLUS

- Butée de profondeur, pour ne pas abîmer la plaque
- Aimant pour un très bon maintien de la vis



## EMBOUT 1/4 PH2 AIMANTÉ POUR PLAQUISTE

Spécial plaquiste : butée de profondeur, pour ne pas abîmer la plaque. Aimant pour un très bon maintien de la vis.



				B blister de 1	
	L mm	g	Ref.		
PH2	50	17	504108		1

## BANJO MÉTALLIQUE DISTRIBUTEUR DE BANDE ENDUITE

Distribue et coupe des bandes déjà enduites. Avec un compartiment pour la bande et un pour l'enduit. Débit d'enduit réglable. Système de coupe de la bande. Fermeture étanche.



kg	Ref.	
1,90	505010	1

## BANJO PLASTIQUE DISTRIBUTEUR DE BANDE ENDUITE

Avec un compartiment pour la bande et un pour l'enduit. Débit d'enduit réglable. Fermeture étanche. Léger.



kg	Ref.	
1,20	505020	1

## ÉCHASSES

Réglage simple. En aluminium très résistant. Avec semelles caoutchouc antidérapantes. Equipé d'un système d'articulation reproduisant le mouvement de la cheville. Avec sangles de tenue de la jambe, du pied et de la cheville. Charge maximum : 100 kg.



Réglable de cm (la paire)	Charge maximum kg	Ref.	
46 > 76	100	505000	1
60 > 100	100	504990	1

## TRUELLE D'ANGLE INTÉRIEUR



### + LES PLUS

#### SPECIAL PLAQUISTE

- La souplesse de la lame en acier inox 4/10<sup>ème</sup> évite l'arrachement de la bande à joint dans les angles
- Poignée monobloc ergonomique pour une très bonne prise en main.



## TRUELLE D'ANGLE INTÉRIEUR SPÉCIALE PLAQUISTE

Acier inox très souple, 4/10<sup>ème</sup>.



Dimensions cm	Angle	Ref.	
200 x 120	103°	502180	1



16



62



96



120



126



156



188



224



248



254



300



316



340



390



462



488



419



# PLAQUISTE : JOINTER

## COUTEAU À ENDUIRE INOX AVEC EMBOUT DE VISSAGE

### CARACTÉRISTIQUES

- Lame inox, flexible, polie brillant.
- Embout PH2, pour vis Phillips pour plaques de plâtre.
- Manche bi-matière toucher "Soft", pour une très bonne prise en main.



### COUTEAU À ENDUIRE INOX AVEC EMBOUT

Manche bi-matière.  
Embout de vissage PH2.  
Lame inox flexible.



L mm	Largeur pouces	Ref.	
102	4	221770	6
127	5	221780	6
152	6	221790	6

>> Voir tous nos couteaux **chapitre Platoirs-couteaux**

## BAC À ENDUIT PLASTIQUE



### UTILISATION

- Facilite l'application de l'enduit par une bonne tenue du produit à l'intérieur du bac
- Equipé d'une poignée et d'une lame pour racle le couteau.



### BAC À ENDUIT PLASTIQUE



Dimensions cm	Ref.	
32 x 11 x 3	101810	1



## PLATOIR COURBE SPÉCIAL PLAQUISTE



### + LES PLUS

#### SPÉCIAL PLAQUISTE

- La lame courbe facilite le chargement et la finition du joint
- Lame inox courbe 28 x 12 cm
- Pour une excellente finition

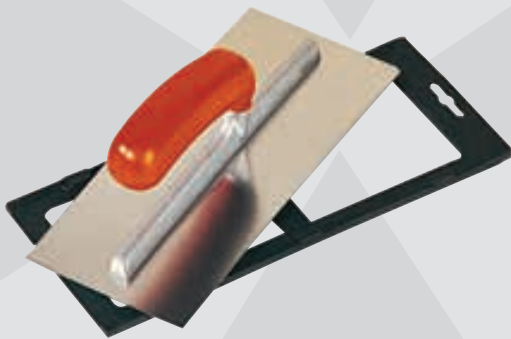

## PLATOIR LAME COURBE SPÉCIAL PLAQUISTE

Lame inox courbe.



Dimensions cm	Epaisseur mm	Ref.	📦
28 x 12	0,6	231321	3

>> Voir tous nos platoirs *chapitre Platoirs-couteaux*

## DÉROULEUR DE BANDES

Facilite le déroulement des bandes pour les joints.  
En acier zingué. Avec crochet pour fixer à la ceinture.



Ø cylindre mm	Ref.	📦
51	502150	1

## COUTEAU À SERRER LES BANDES

### + LES PLUS

- Outil indispensable pour serrer les bandes
- Lame rigide et déportée
- Largeur : 7 cm.



## COUTEAU À SERRER LES BANDES



Dimension cm	Ref.	📦
7	224200	1



16



62



96



120



126



156



188



224



248



254



300



316



340



390



462



488



421



# PLAQUISTE : PONCER, PERCER

## CALE À PONCER

En polystyrène monobloc.  
Sous-couche mousse.  
Livrée sans abrasif.



Dimensions cm	Ref.	
24 x 8	502700	1

## PONCEUSE À MANCHE

Monture en alliage aluminium. Semelle mousse caoutchouc. Système de blocage de l'abrasif. Manche bois de 1,30 m pour le ponçage des surfaces hautes. Livrée sans abrasif.



Dimensions cm	L manche m	Ref.	
24 x 8	1,30	505110	1

## ABRASIF

Adaptable sur cales à poncer réf. 505110 et 502700.  
Treillis abrasif 280 x 93 mm.

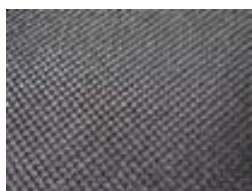

Grain moyen	Nb feuilles par paquet	Dimensions mm	Ref.	
100	20	280 x 93	502710	1
100	5	280 x 93	502730	1
60-80-120	6 : 2x60 - 2x80 - 2x120	280 x 93	502740	1

## PAPIER ABRASIF



Grain moyen	Nb feuilles par paquet	Dimensions mm	Ref.	
100	20	280 x 95	502720	1

## SCIE À GUICHET

### UTILISATION

- Pour tous les professionnels du bâtiment
- Pour découper les plaques de plâtre, le bois, le PVC, le béton cellulaire...

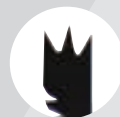

### CARACTÉRISTIQUES

- Pointes en trident pour un perçage facile et précis
- Denture triple biseaux
- Longueur de lame 160 mm
- Lame en acier carbone haute qualité
- Poignée ergonomique bi-matière toucher «Soft».



## SCIE À GUICHET POIGNÉE BI-MATIÈRE «SOFT»

Denture triple biseaux.



L lame cm	Ref.	
16	832918	1

## SCIE MÈCHE

Avec vrille d'amorçage et denture pour découpes intérieures dans plaques de plâtre, bois, cuir, plastique. Manche plastique.



L cm	L mèche cm	Mèche Ø mm	Ref.		Ref.	
27	17	5	832900	5	832908	1



# PLAQUISTE C'EST AUSSI...

COUPEAU À JOINTER  
LES BANDES

>> PAGE 476

Ref.	
224250	1



COUPEAU À ENDUIRE  
LAME INOX TREMPÉ,  
SÉRIE PREMIUM

>> PAGE 477

Ref.	
223400	6



COUPEAU AMÉRICAIN  
MANCHE BI-MATIÈRE  
"SOFT"

>> PAGE 478

Ref.	
221720	6



PLATOIR LAME INOX COURBE  
0,6 MM MONTURE ALU

>> PAGE 466

Ref.	
234551	3



PLATOIR DEUX MAINS  
LAME INOX 0,6 MM

>> PAGE 465

Ref.	
232031	3



PLATOIR MONTURE ALU  
LAME INOX BISEAUTÉE  
0,6 MM

>> PAGE 464

Ref.	
231031	3



ERGOLAME®

>> PAGE 480

Ref.	
227510	2



ESCABEAU PRO  
ALUMINIUM  
LESCABO®

>> PAGE 305

Ref.	
201980	1



PLATEFORME  
NINJA

>> PAGE 312

Ref.	
500610	1



PERCHE  
ERGOLAME®

>> PAGE 481

Ref.	
227400	2





# PLÂTRIER : RÈGLES À BÂTIR

## RÈGLE À BÂTIR À PÉDALE



### + LES PLUS

- Mise en oeuvre rapide sur le chantier grâce à deux niveaux incorporés
- Livré avec pelote de cordeau
- Profil aluminium 50 x 50 mm : section idéale pour bâtir les cloisons
- Aisance de travail grâce à la pédale
- Le cordeau se fixe aisément sur la règle grâce aux platines supérieure et inférieure équipées de passe-fils qui permettent de bloquer le cordeau sans faire de nœud : gain de temps.



### UTILISATION

- Pour implanter et bâtir les cloisons en briques, carreaux de briques, carreaux de plâtre...

### CARACTÉRISTIQUES

- Le profilé aluminium ne s'oxyde pas et est léger.
- La règle est compatible avec l'utilisation de la pince à bâtir réf. 203120
- Ouverture maximum : 3,60 m
- Longueur fermée de la règle : 2,30 m.



Platine supérieure avec passe-fils



Niveaux incorporés et blocage de la règle



Pédale montée sur ressort

La pédale permet d'agir sur le ressort du pied de la règle et ainsi d'avoir les deux mains libres pour la mise à niveau de la règle entre le sol et le plafond

## RÈGLE À BÂTIR À PÉDALE

Pour implanter et bâtir les cloisons en briques, carreaux de briques, carreaux de plâtre...



Longueur fermée m	Ouverture maximum m	kg	Ref.	
2,30	3,62	3,60	201200	1

# PLÂTRIER : RÈGLES À BÂTIR



## RÈGLE TÉLESCOPIQUE PORTE-CORDEAU



201170

201180

### UTILISATION

- A utiliser pour implanter et bâtir les cloisons en briques, carreaux de briques, carreaux de plâtre etc...
- Équipée d'un pied avec ressort et d'une vis papillon de blocage qui permettent de fixer la règle entre sol et plafond.
- Équipée de passe-fils pour cordeau vertical 1,5 mm
- Le long du cordeau vertical peut coulisser un cordeau horizontal.

### CARACTÉRISTIQUES

- En acier peint époxy gris.

Pédale de blocage de la règle pour un meilleur confort de travail

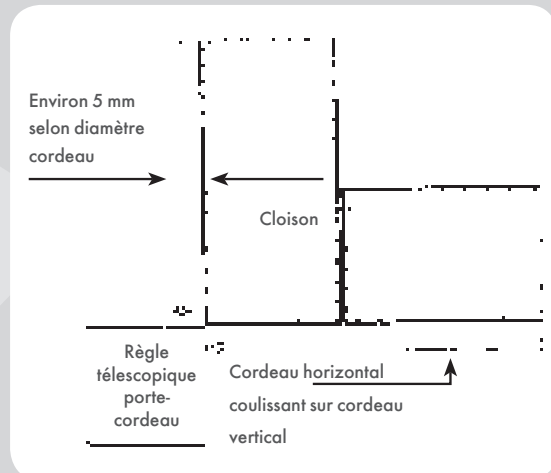

### RÈGLE TÉLESCOPIQUE PORTE-CORDEAU AVEC CORDEAU VERTICAL

Livrée avec cordeau vertical.



Longueur fermée m	Ouverture maximale m	Ref.	☐
1,70	3	201170	2
2,50	4,50	201250	2

### RÈGLE TÉLESCOPIQUE PORTE-CORDEAU

Livrée sans cordeau vertical.



Longueur fermée m	Ouverture maximale m	Ref.	☐
1,70	3	201180	2

## PINCE À BÂTIR



### UTILISATION

- Utilisable avec la règle télescopique porte-cordeau, la règle à bâtir à pédale ou la règle carrée 50 x 50 mm
- Permet de bloquer contre la règle le carreau de brique ou le carreau de plâtre pendant le temps de prise du joint.
- Réglage du serrage : de 0 à 15 cm.



### PINCE À BÂTIR

Réglage du serrage : de 0 à 15 cm. Jeu de 2.



Blisters de 2

Serrage cm	Ref.	☐
0 > 15	203120	1



16



62



96



120



126



156



188



224



248



254



300



316



340



390



462



488

# PLÂTRIER : RÈGLES ALUMINIUM

## RÈGLES ALU

Règle extensible 100 x 18 mm

Règle à lisser fermée Profil "h"

Règle triangulaire à dresser

Règle carrée 50 x 50 mm



Les conditionnements s'entendent par types de règles de même longueur.

### RÈGLE ALU CARRÉE 50 X 50 MM

Adaptée à toutes les hauteurs de plafonds.

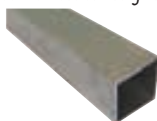

L m	Ref.	📦
2,40	353240	4
2,50	353250	4
2,60	353260	4
2,75	353275	4
3	353300	4
3,50	353350	4
4	353400	4
5	353500	4
6	353600	4

### RÈGLE ALU TRIANGULAIRE SPÉCIALE POUR DRESSER

Avec nervures pour une bonne tenue en main. Livrée avec embouts plastiques.



L m	Ref.	📦
1	358100	4
1,25	358125	4
1,50	358150	4
1,75	358175	4
2	358200	4
2,50	358250	4
3	358300	4

### RÈGLE ALU À LISSER FERMÉE, PROFIL "H"

Livrée avec embouts plastiques.

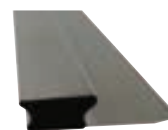

L m	Ref.	📦
1	357100	2
1,25	357125	2
1,50	357150	2
2	357200	2
2,50	357250	2
3	357300	2

### RÈGLE ALU EXTENSIBLE 100 X 18 MM

2 profils coulissants.

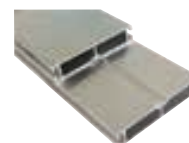

Longueur fermée m	Longueur ouverte m	Ref.	📦
2	3,70	355200	1
2,50	4,70	355250	1
3	5,70	355300	1
4	7,70	355400	1

## FIXE-RÈGLE PAR VÉRIN

### + LE PLUS

■ Sécurise l'utilisation de la règle carrée



### UTILISATION

- Est utilisé avec la règle carrée 50 x 50 mm.
- Permet un réglage entre l'extrémité supérieure de la règle et le plafond, de 15 à 36 cm.

### CARACTÉRISTIQUES

- En aluminium et matière plastique.

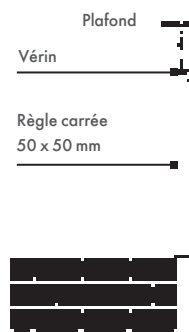

### FIXE-RÈGLE PAR VÉRIN

Ref.	📦
201300	1



16



62



96



120



126



156



188



224



248



254



300



316



340



390



462



488



427



## RÈGLE ALU À DRESSER BISEAUTÉE

### CARACTÉRISTIQUES

- Profil 100 x 18 avec un côté biseauté
- Livrée avec embouts plastiques.



## RÈGLE ALU À DRESSER BISEAUTÉE

Profil 100 x 18 avec un côté biseauté.



L m	Ref.	📦
1	357610	4
1,25	357612	4
1,50	357615	4
1,75	357617	4
2	357620	4
2,50	357625	4

## EMBOUPTS PLASTIQUE POUR RÈGLE BISEAUTÉE

1 embout droit et 1 embout gauche.



	Ref.	📦
Vendus par paire	357690	1

## RÈGLE «H» OUVERTE LISSE

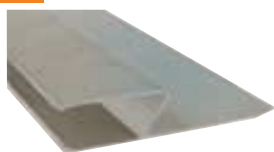

L m	Ref.	📦
1	358610	2
1,25	358612	2
1,50	358615	2
2	358620	2
2,50	358625	2



## RÈGLE «H» OUVERTE CRANTÉE

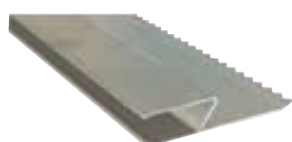

L m	Ref.	📦
1	358710	2
1,25	358712	2
1,50	358715	2
2	358720	2
2,50	358725	2

## RÈGLE À DRESSER À POIGNÉE



### UTILISATION

- Pour la réalisation d'enduits
- Adaptée pour les enduits de façade projetés.

### CARACTÉRISTIQUES

- Profil aluminium
- Poignée bois
- Monture polypropylène résistante aux solvants.



## RÈGLE À DRESSER À POIGNÉE UN CÔTÉ DENTÉ

Pour la réalisation d'enduits de façade projetés. Profil aluminium avec un côté denté (dégrossissage) 5 x 5 mm.



Dim. cm	Ref.	📦
80 x 10	226806	1
100 x 10	226816	1
120 x 10	226826	1

## RÈGLE À DRESSER À POIGNÉE LISSE

Pour la réalisation d'enduits de façade projetés. Profil aluminium sans dent / lisse.



Dim. cm	Ref.	📦
80 x 10	226800	1
100 x 10	226810	1
120 x 10	226820	1

# PLÂTRIER : TRUELLES GAMME PRO MONDELIN

## TRUELLE À BRIQUETER

Acier trempé. Manche bois verni. Epaisseur : 2 mm.

PLÂTRIER  
MAÇON



L cm	Epaisseur mm	Ref.	📦
20	2	335200	1

## TRUELLE D'ANGLE EXTERIEUR

Lame inox. Manche polypropylène ergonomique. Epaisseur : 0,6 mm.

PLÂTRIER



L x l mm	Angle	Epaisseur mm	Ref.	📦
200 x 120	87°	0,6	338090	1

## TRUELLE D'ANGLE INTERIEUR

Lame inox. Manche polypropylène ergonomique. Epaisseur : 0,6 mm.

PLÂTRIER

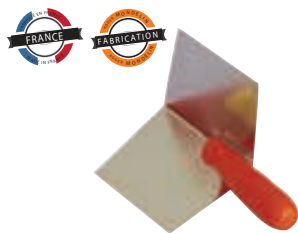

L x l mm	Angle	Epaisseur mm	Ref.	📦
200 x 120	103°	0,6	338100	1

## TRUELLE BERTHELET

Acier trempé. Manche bois verni.

PLÂTRIER



	L cm	Ref.	📦
1 côté denté	6	338060	1

## TRUELLE FAÇON REIMS INOX

Epaisseur : 0,8 mm. Manche bois verni rouge.

PLÂTRIER



L cm	Epaisseur mm	Ref.	📦
16	0,8	334251	1

## TRUELLE RONDE INOX MANCHE BIMATIÈRE MONDELIN

Manche ergonomique bimatière.

PLÂTRIER



L cm	l cm	D cm	kg	Ref.	📦
20	11	34	285	330206	1
22	12	36	305	330226	1

## TRUELLE CARRÉE INOX MANCHE BIMATIÈRE MONDELIN

Manche ergonomique bimatière.

PLÂTRIER



L cm	l cm	D cm	kg	Ref.	📦
20	12	34	335	331206	1

## TRUELLE LANGUE DE CHAT INOX MANCHE BIMATIÈRE MONDELIN

Manche ergonomique bimatière.

PLÂTRIER



L cm	l cm	D cm	kg	Ref.	📦
16	5	28	135	332166	1

## PERCHE ERGOLAME®



### UTILISATION

- Permet de lisser les plafonds depuis le sol, en toute sécurité et sur de grandes surfaces
- Compatible avec les Ergolames lissage et finition

### CARACTERISTIQUES

- Réglable de 1,10 m à 2,10 m
- Le réglage de l'angle se fait par 7 positions de 15°
- Robuste



## PERCHE ERGOLAME®

Réglable de 1,10 m à 2,10 m. Le réglage de l'angle se fait par 7 positions de 15°. Robuste.



Ref.	📦
227400	2



## ERGOLAME®



## ERGOLAME®

### + LES PLUS

- S'utilise d'un geste, naturel et efficace
- Immédiatement adopté par les artisans après essai.

#### CARACTÉRISTIQUES

- Lame entièrement dégagée pour un lissage "sans trace"
- Lame pliée pour conjuguer rectitude et souplesse
- Interchangeabilité de la lame aisée grâce à la clé de serrage
- Nettoyage facile.

#### MULTI-USAGES

- ERGOLAME® lissage 6/10ème : pour le lissage des enduits, serrage des bandes, réalisation des joints de plaque de plâtre, projeté façade, plâtre...  
Lame inox rigide 100 mm. Épaisseur : 0,6 mm.
- ERGOLAME® finition 4/10ème : pour réalisation des enduits de finition, de décoration (fibrite, enduit airless, enduit stuc...).  
Lame inox extra souple 120 mm. Épaisseur : 0,4 mm.



Perche dans notre famille Couteaux



Vue de dessous



#### LAME ERGOLAME®

Longueur mm	Utilisation	Largeur mm	Épaisseur mm	Ref.	☐
150	Lissage	100	0,6	227501	1
300	Lissage	100	0,6	227511	1
500	Lissage	100	0,6	227521	1
600	Lissage	100	0,6	227531	1
800	Lissage	100	0,6	227541	1
150	Finition	120	0,4	227601	1
300	Finition	120	0,4	227611	1

#### ERGOLAME® LISSAGE

ERGOLAME® lissage 6/10ème  
Lame inox rigide 100 mm,  
épaisseur : 0,6 mm.



Longueur mm	Largeur mm	Épaisseur mm	Ref.	☐
150	100	0,6	227500	2
300	100	0,6	227510	2
500	100	0,6	227520	2
600	100	0,6	227530	2
800	100	0,6	227540	2

#### ERGOLAME® FINITION

ERGOLAME® finition 4/10ème  
Lame inox extra souple 120 mm,  
épaisseur : 0,4 mm.

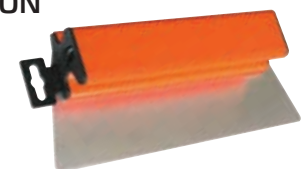

Longueur mm	Largeur mm	Épaisseur mm	Ref.	☐
150	120	0,4	227600	2
300	120	0,4	227610	2
500	120	0,4	227620	2
600	120	0,4	227630	2
800	120	0,4	227640	2



16



62



96



120



126



156



188



224



248



254



300



316



340



390



462



488

# PLÂTRIER : AUGES

## AUGE À PLÂTRE MONOBLOC

En polyéthylène blanc.



Capacité L	L x l x P cm	kg	Ref.	📦
33	72 x 43 x 28	5	243030	1

## REHAUSSE POUR AUGE À PLÂTRE MONOBLOC 100 L

Tube acier peint.  
Facilement démontable.  
2 positions de travail :  
fond plat / fond oblique.



H mm	Ref.	📦
710	243110	1

## LOUCHE DE PLÂTRIER

Bol acier zingué.  
Poignée bois.



Ref.	📦
244600	1

## GÂCHOIR AVEC MANCHE

En matière plastique.  
Livré avec manche en bois dur de 1 m.



Dim. cm	Ref.	📦
30	244570	1
40	244560	1

## AUGE À FOND CYLINDRIQUE 210 L AVEC PIÈTEMENT

Pour le gâchage des plâtres allégés.  
Livrée avec :  
- 1 piètement ergonomique tubulaire équipé de deux roulettes  
- 1 réglette graduée de 10 litres à 200 litres pouvant se fixer sur la cuve.  
Cuve en polyéthylène blanc résistant aux chocs.



Capacité L	Dim. intérieures cm	Profondeur cm	kg	Ref.	📦
210	54 x 98	50	14,5	243200	1

## RÉGLETTE

En PS blanc. Graduée de 10 litres à 200 litres.

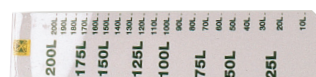

Ref.	📦
243220	1

## AUGE À FOND CYLINDRIQUE 210 L SANS PIÈTEMENT

En polyéthylène blanc.



Capacité L	L x l cm	Profondeur cm	kg	Ref.	📦
210	107,5 x 62,5	49,50	15	243230	1

## GUILLAUMES & FROTTOIRS

### GUILLAUME

#### UTILISATION

- Pour dresser les cueillies.

#### CARACTÉRISTIQUES

- Monture bois.
- Lame inox.



### GUILLAUME

Pour dresser les cueillies.  
Monture bois. Lame inox.



L cm	l cm	Ref.	📦
50	7,50	202070	1





## RABÔT À PLÂTRE



Pour dresser les angles.  
Embase en matière synthétique.  
Poignée bois. 8 lames acier de 10 x 2 cm.



Dim. cm	Ref.	
44	202500	1

## COUTEAU À PLÂTRE



Lame inox trempé.  
Monture bois.



Dim. cm	Ref.	
35	225350	1
50	225500	1
60	225600	1
80	225800	1

## PLATEAU «PLUME» PLÂTRIER



Avec alèse en bois dur.  
Poignée vendue séparément.



L x l cm	Ref.	
60 x 19	211960	1
60 x 22	212260	1
60 x 29	212960	1
60 x 33	213360	1
70 x 19	211970	1
70 x 22	212270	1
70 x 29	212970	1

## POIGNÉE PLASTIQUE LIVRÉE AVEC VIS



Dimensions	Ref.	
Petit modèle pour plateau plâtrier de 60 cm	214600	1
Grand modèle pour plateau plâtrier de 70 cm	214700	1

## TALOCHE ALUMINIUM



Préconisée pour les plâtres allégés. Plateau aluminium. Poignée plastique montée.



L x l cm	Ref.	
60 x 22	215600	1
65 x 24	215650	1

## FROTTOIR MONOBLOC SPONGIEUX ORANGE

Préconisé pour les plâtres allégés. Spongieux orange de 18 mm. Poignée monobloc en PS choc.



L x l cm	Ref.	
29 x 14	317040	1

## FROTTOIR MONOBLOC SPONGIEUX ORANGE FIN

Préconisé pour les plâtres allégés. Spongieux orange de 18 mm fines alvéoles. Poignée monobloc en PS choc.



L x l cm	Ref.	
29 x 14	317060	1

## FROTTOIR MONOBLOC POINTU SPONGIEUX ORANGE

Préconisé pour les plâtres allégés. Spongieux orange de 18 mm. Poignée monobloc en PS choc.



L x l cm	Ref.	
27 x 14	317030	1

## FROTTOIR PLASTIQUE SPONGIEUX ORANGE

Préconisé pour les plâtres allégés. Plateau plastique avec spongieux orange de 18 mm. Poignée plastique.



L x l cm	Ref.	
29 x 14	317020	1

## FROTTOIR BOIS SPONGIEUX ORANGE

Préconisé pour les plâtres allégés. Plateau bois avec spongieux orange de 18 mm. Poignée plastique montée.



L x l cm	Ref.	
20 x 13	317000	1



16



62



96



120



126



156



188



224



248



254



300



316



340



390



462



488

## TRÉPIED PLIABLE AVEC COULISSE

Trépied métallique de plâtrier

### CARACTÉRISTIQUES

- Peinture époxy
- Charge utile : 250 kg



Trépied pliable

Découpe laser des tubes



Trépied pliable avec coulisse  
201600 + 201620

### TRÉPIED MÉTALLIQUE DE PLÂTRIER PLIABLE

Charge utile : 250 kg.



H mm	Charge utile kg	⚖️ kg	Ref.	📦
490	250	3,7	201600	1

### COULISSE POUR TRÉPIED

Adaptable sur trépied fixe ou pliable. Nombre de trous : 6.  
Entraxe des trous : 80 mm.



L mm	Réglage du trépied + coulisse mm	⚖️ kg	Ref.	📦
1400	1435 > 1835	3,1	201630	1
890	910 > 1310	2,3	201610	1
505	525 > 925	1,5	201620	1

### TRÉPIED MÉTALLIQUE DE PLÂTRIER FIXE

Charge utile : 250 kg.



H mm	Charge utile kg	⚖️ kg	Ref.	📦
490	250	2,3	201590	1

# PLÂTRIER : ENCOLLAGE PAPIER PEINT



## BROSSE À ENCOLLER ET À BADIGEON

Structure et poignée en polypropylène.  
Synthétique fleuré gris.



L x l support mm	Nb rangs	Ref.	📦
175 x 78	9	862780	1

## BROSSE À ENCOLLER ET À BADIGEON

Poignée bois verni.  
Support polypropylène.  
Mélange soies grises.  
Sortie : 85 mm.



L x l support mm	Sortie mm	Ref.	📦
160 x 65	85	863290	1

## BROSSE DE COLLEUR STANDARD

Poignée bois. Vinyle fleuré. Sortie : 52 mm.  
3 rangs.



L cm	Nb rangs	Sortie mm	Ref.	📦
30	3	52	862800	1

## BROSSE À ÉPOUSSETER

Poignée bois naturel.  
Sortie : 47 mm. 4 rangs.



L cm	Nb rangs	Sortie mm	Ref.	📦
21	4	47	862820	1

## MACHINE À ENCOLLER MINI-FIX MÉTAL SUR TABLE

Pour papiers peints jusqu'à 57 cm de large.  
Bac à colle en tôle d'acier peint. Rouleau à encoller en PVC. Racleur en acier inoxydable.



L x l x H cm	📦 kg	Ref.	📦
60 x 29 x 10	5	120000	1

## LAMES & COUTEAUX

### LAME À ARASER

Lame inox 18/8.  
Poignée bois.



L cm	Épaisseur de lame mm	Ref.	📦
60	0,6	224900	1

### COUTEAU À MAROUFLER PLASTIQUE

Pour la pose des revêtements muraux.  
Avec une poignée pour une bonne tenue en main.  
Qualité normale en polystyrène



Polystyrène	Ref.	📦
	101000	10

### COUTEAU À MAROUFLER POLYCARBONATE

Pour la pose des revêtements muraux.  
Avec une poignée pour une bonne tenue en main.  
En polycarbonate transparent.  
Qualité supérieure.



Ref.	📦
101010	10

### COUTEAU TRIANGULAIRE

Pour façonner les enduits.  
En matière plastique.



Dim. cm	Ref.	📦
20 x 20 x 20	101020	1



16



62



96



120



126



156



188



224



248



254



300



316



340



390



462



488



## COUTEAU FORME TRAPÈZE

Pour le marouflage et le façonnage des enduits. En matière plastique.



Dim. cm	Ref.	
24,5 x 19 x 12,5	101030	1

## RACLOIR À PEINTURE

Manche aluminium avec poignée. Lame interchangeable à quatre côtés.



Ref.	
101300	1

## RACLOIR BOULE À PEINTURE

Monture plastique. Lame interchangeable à quatre côtés.



Ref.	
101310	1

## LOT DE 2 LAMES DE RECHANGE

Pour racloirs réf. 101300 ou 101310.



x 2	Ref.	
	101400	2

## GRATTOIR À PEINTURE TAJIMA®

Tête en aluminium. Manche renforcé avec extrémité en acier pouvant servir d'embout de frappe. La lame de 18 x 0,6 mm permet de racler précisément. Voir lames réf. 103548. Livré avec 3 lames de rechange.



Ref.	
101338	1

## MALAXEUR HÉLICE MATÉRIAUX LIQUIDES KR 85 S

Livré avec embouts plastiques pour présentation sur broche. A utiliser avec une perceuse à vitesse variable de 500 à 1500 tr/mn, pour peintures murales, vernis et peintures émulsions.



Quantité à mélanger kg	Vitesse en charge conseillée tr/min	Puissance minimale de la perceuse W	L totale mm	Ø base mm	Ref.	
0-5	800/1000	300	400	85	881070	1

## MALAXEUR HÉLICE PLASTIQUE MINI 60

Livré avec embouts plastiques pour présentation sur broche. A utiliser avec une perceuse à vitesse variable de 500 à 1500 tr/mn, pour peintures.

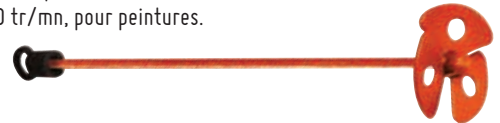

Quantité à mélanger kg	Vitesse en charge conseillée tr/min	Puissance minimale de la perceuse W	L totale mm	Ø base mm	Ref.	
0-5	800/1000	300	350	60	881000	1

>> Voir nos malaxeurs et mélangeurs chapitre Outils universels bâtiment

## RUBAN DE MASQUAGE

Résistance à la température 60°. Ruban adhésif papier. Masquage pour travaux d'intérieur.



Dimensions	Ref.	
50 m x 19 mm	852520	48
50 m x 25 mm	852530	36
50 m x 50 mm	852550	18

## RUBAN DE MASQUAGE

Pour tous travaux intérieurs et extérieurs très résistant. Ruban adhésif PVC souple orange.



Dimensions	Ref.	
33 m x 50 mm	852500	36

## BANDE DE RÉPARATION

Très bon adhésif qui résiste bien au froid. Toile étanche, grise adhésive.



Dimensions	Ref.	
25 m x 50 mm	852560	24



## BOITE À COUPE FORME V GRAND MODÈLE

Pour les coupes de corniches.  
Coupe à 45° et 90° sur  
moulure, corniches plates  
et d'angle. Coupe jusqu'à  
150 mm de large. En bois  
composite.



Dimensions intérieures mm	Ref.	📦
550 x 155 x 220	101510	1

## BOITE À COUPE FORME V PETIT MODÈLE

Coupe à 45° et 90° sur  
moulure, corniches plates et  
d'angle. Coupe jusqu'à 90 mm  
de large. En bois composite.



Dimensions intérieures mm	Ref.	📦
350 x 90 x 125	101520	1

## BOITE À COUPE PLASTIQUE

Coupe pour encadrement cimaise, plinthe  
et encadrement de porte. Coupe à onglets  
de moulure de petites dimensions.  
Largeur intérieure : 50 mm.



Dimensions intérieures mm	Ref.	📦
250 x 50 x 40	101500	6

## SCIE POUR MOULURE POLYSTYRÈNE

Pour la découpe de moulures, baguettes, profils en bois ou aluminium.  
Poignée plastique.



Longueur lame cm	Ref.	📦
42	101550	1

## SCIE DE PLACAGE

Pour la découpe de  
placage. Denture fine  
trempée. Poignée  
ergonomique, toucher  
«Soft».



Longueur lame cm	Ref.	📦
32	830520	5

## SCIE À ARASER À DOS

Pour travaux fins,  
ébénisterie et boîte à  
coupe. Denture pointue  
fine, trempée. 14 dents  
par pouce.



Longueur lame cm	Ref.	📦
35	830530	5

## ÉPONGE EN MOUSSE POLYURÉTHANE



L x l x H cm	Ref.	📦
17 x 12 x 6,5	101700	12
14 x 10 x 6	101710	12

## ÉPONGE VÉGÉTALE RENFORCÉE

Spéciale gros travaux.



L x l x H cm	Ref.	📦
14,6 x 9,6 x 6	101690	12

## ÉPONGE NATURELLE GERBIS

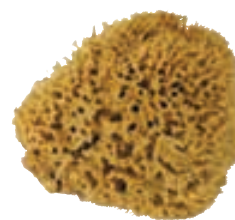

Ø cm	Calibre	Ref.	📦
16	6,5	101720	1

## BROSSE À BADIGEON

Manche bois naturel.  
Mélange crin nylon.  
Virole acier - couvercle  
plastique.



Ø	Sortie	Ref.	📦
56	68	862350	1



16



62



96



120



126



156



188



224



248



254



300



316



340



390



462



488



435

## BROSSES RONDES ET PLATES

### GAMME

- 2 niveaux de gamme pour les brosses rondes : série bâtiment et professionnelle.
- Manche bois naturel et soies naturelles, sauf modèles lazure manche polypropylène soies synthétiques.



### POUCE À RECHAMPIR SÉRIE PROFESSIONNELLE

Collet ficelle. Manche bois naturel. Soies naturelles. Virole cuivre.



N°	Ø	Sortie	Ref.	☐
3/0	15	50	862200	6
0	18	60	862210	6
2	21	67	862220	6
4	25	73	862230	6

### POUCE À RECHAMPIR SÉRIE BÂTIMENT

Manche bois naturel. Soies naturelles. Virole acier cuivré.



N°	Ø	Sortie	Ref.	☐
0	18	47	862260	6
2	21	57	862270	6
4	25	63	862280	6

### POUCE SÉRIE BÂTIMENT

Manche bois. Soies naturelles. Virole acier cuivré.



N°	Ø	Sortie	Ref.	☐
2	21	56	862100	6
4	25	60	862110	6
6	29	66	862120	6
8	32	66	862130	6

### POUCE À RECHAMPIR SPÉCIAL LASURE

Manche polypropylène. Soies synthétiques. Virole inox.



N°	Ø	Sortie	Ref.	☐
3/0	15	49	862300	6
0	18	49	862310	6
2	21	49	862320	6
4	25	55	862330	6



## QUEUE DE MORUE À VERNIR SÉRIE ÉPAISSE

Manche bois satiné.  
Soies naturelles.  
Virole fer blanc.



Largeur mm	Épaisseur mm	Sortie	Ref.	📦
50	17	57	862390	6

## QUEUE DE MORUE À LAQUER SÉRIE MOYENNE

Manche bois naturel.  
Soies naturelles.  
Virole fer blanc nickelé.



Largeur mm	Épaisseur mm	Sortie	Ref.	📦
20	8	44	862420	6
30	10	44	862430	6
40	12	44	862440	6
50	13	50	862450	6
60	13,5	57	862460	6
70	14	57	862470	6

## QUEUE DE MORUE SÉRIE MINCE

Manche bois. Soies naturelles. Virole fer poli.



Largeur mm	Épaisseur mm	Sortie	Ref.	📦
30	7	44	862540	6
40	8,5	44	862550	6
50	9,5	50	862560	6
60	10	50	862570	6

## QUEUE DE MORUE MINCE À NETTOYER

Manche bois. Nylon blanc.  
Virole fer blanc.



Largeur mm	Épaisseur mm	Sortie	Ref.	📦
30	7	35	862600	6
40	9,5	40	862610	6
60	10	40	862620	6

## QUEUE DE MORUE SPÉCIALE LASURE

Manche polypropylène.  
Soies synthétiques. Virole acier nickelé.



Largeur mm	Épaisseur mm	Sortie	Ref.	📦
30	15	44	862900	6
40	15	44	862910	6
50	15	50	862920	6

## SPALTER

Manche bois naturel. Soies naturelles. Virole acier cuivré.



Largeur mm	Épaisseur mm	Sortie	Ref.	📦
100	9	44	862640	3
140	9	44	862650	3

## QUEUE RADIATEUR STANDARD

Manche bois naturel coudé sur plat. Très pratique. Soies naturelles. Virole acier cuivré.



Largeur mm	Épaisseur mm	Sortie	Ref.	📦
40	9,5	50	862740	6

## LOT DE 3 BROSSES

1 pouce n°6 : Ø 29 série bâtiment  
1 rechapir n°4 : Ø 25 série bâtiment  
1 queue de morue à laquer largeur 70 mm.



Ref.	📦
970130	10



16



62



96



120



126



156



188



224



248



254



300



316



340



390



462



488

## ROULEAUX MANCHES BOIS GAMME PRO

Rouleaux et manchons gamme professionnelle

- Les rouleaux complets sont équipés avec la monture à vis et bague réglable, manche bois (réf. : 861300).



## MÉCHÉ LONG GAMME PRO

Fibre polyamide 18 mm. Spécial ravalement pour produits semi-épais à fluides. Sur ciment, béton, parpaings et briques.



	Fibre mm	Ø tube	L mm	Ref.	☐
Manchon seul	18	47	180	861010	1
Rouleau complet	18	47	180	860610	1

## ANTIGOUTTE RAYÉ JAUNE GAMME PRO

Fibre polyamide. Pour toutes peintures sur surfaces régulières : murs et plafonds.



	Fibre mm	Ø tube	L mm	Ref.	☐
Manchon seul	12	47	180	861020	1
Rouleau complet	12	47	180	860620	1

## POLYESTER MAILLE GAMME PRO

Fibre polyester. Spécial peintures acryliques et lasures.



	Fibre mm	Ø tube	L mm	Ref.	☐
Manchon seul	12	47	180	861030	1
Rouleau complet	12	47	180	860630	1

## LAQUEUR MOUSSE FLOQUÉE GAMME PRO

Fibres polyamide rases floquées. Pour laques, glycéros et vernis.



	Ø tube	L mm	Ref.	☐
Manchon seul	60	180	861040	1
Rouleau complet	60	180	860640	1

## LAQUEUR VELOURS COLLÉ GAMME PRO

Pure laine. Pour travaux soignés. Pour laques, vernis et peintures à aspect lisse. A utiliser sur surfaces préparées très lisses.



	Fibre mm	Ø tube	L mm	Ref.	☐
Manchon seul	4	55	180	861050	1
Rouleau complet	4	55	180	860650	1

## TROUS BRÛLÉS GAMME PRO

Mousse alvéolée. Aspect gros grain pour décors rustiques. Pour crépis en pâte ou enduits.



	Ø tube	L mm	Ref.	☐
Manchon seul	70	180	861060	1
Rouleau complet	70	180	860660	1

## NID D'ABEILLE GAMME PRO

Mousse alvéolée. Aspect petit grain pour décors rustiques. Pour crépis en pâte ou enduits.



	Ø tube	L mm	Ref.	☐
Manchon seul	73	180	861070	1
Rouleau complet	73	180	860670	1





## ROULEAUX MONTURE AUTOBLOQUANTE PLASTIQUE

Rouleaux et manchons gamme standard  
Manchons à clips adaptables sur montage autobloquante

Les rouleaux complets sont équipés avec la montage autobloquante, manche polypropylène (réf. : 861320).



## MÉCHÉ LONG 18 MM GAMME STANDARD

Fibre polyamide. Pour produits semi-épais. Surfaces irrégulières.



	Fibre mm	Ø mm	L mm	Ref.	☐
Manchon seul	18	43	180	861100	1
Rouleau complet	18	43	180	860700	1

## ANTIGOUTTE RAYÉ JAUNE GAMME STANDARD

Fibre polyamide. Murs et plafonds.



	Fibre mm	Ø mm	L mm	Ref.	☐
Manchon seul	12	43	180	861120	1
Rouleau complet	12	43	180	860720	1

## ACRYLAQUE GAMME STANDARD

Fibre polyamide. Pour peintures acryliques et vinyliques. Surfaces régulières et préparées.



	Fibre mm	Ø mm	L mm	Ref.	☐
Manchon seul	6	43	180	861140	1
Rouleau complet	6	43	180	860740	1

## SYNTHÉTIQUE COURT GAMME STANDARD

100% polyester. Pour toutes peintures. Surfaces régulières.



	Fibre mm	Ø mm	L mm	Ref.	☐
Manchon seul	12	43	180	861130	1
Rouleau complet	12	43	180	860730	1

## LAQUEUR GAMME STANDARD

Pure laine. Pour laques, glycéros et vernis. Surfaces régulières et préparées.



	Fibre mm	Ø mm	L mm	Ref.	☐
Manchon seul	4	43	180	861150	1
Rouleau complet	4	43	180	860750	1



16



62



96



120



126



156



188



224



248



254



300



316



340



390



462



488

## ROULEAUX RADIATEUR MANCHE POLYPROPYLENE

Les rouleaux «radiateur» complets sont équipés avec la monture radiateur autobloquante 29 cm, manche polypropylène (réf. : 861350).



## ROULEAU RADIATEUR MÉCHÉ LONG 18 MM

Fibre polyamide. Pour tous travaux de ravalement sur surfaces irrégulières.



	Fibre mm	L mm	Ref.	
Manchon seul	18	110	861210	1
Rouleau complet	18	110	860810	1

## ROULEAU RADIATEUR ANTIGOUTTE RAYÉ JAUNE

100 % polyamide. Pour surfaces régulières. Pour peintures mates et satinées, glycéros, acryliques et vinyliques.



	Fibre mm	L mm	Ref.	
Lot de 2 manchons seuls	13	110	861220	1
Rouleau complet	13	110	860820	1

## ROULEAU RADIATEUR MOUSSE FLOQUÉE ORANGE

Bouts arrondis. Pour peintures, laques, glycéros et vernis.



	L mm	Ref.	
Lot de 2 manchons seuls	110	861240	1
Rouleau complet	110	860840	1

## ROULEAU RADIATEUR MOUSSE BLANCHE HAUTE DENSITÉ

100 % polyester. Bouts arrondis. Pour toutes peintures.



	L mm	Ref.	
Lot de 2 manchons seuls	110	861230	1
Rouleau complet	110	860830	1

## ROULEAU RADIATEUR POLYACRYLIQUE

Polyacrylique. Grain fin pour surfaces préparées et lisses. Pour peintures, laques, glycéros et vernis.



	Fibre mm	L mm	Ref.	
Lot de 2 manchons seuls	4	110	861250	1
Rouleau complet	4	110	860850	1



## MONTURE À VIS ET BAGUE RÉGLABLE MANCHE BOIS

Tige bichromatée. Pour manchons professionnels de 180 mm.

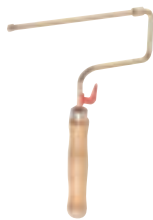

∅ tige mm	Ref.	
8	861300	1

## MONTURE À VIS ET BAGUE FIXE MANCHE POLYPROPYLENE

Tige bichromatée. Pour manchons professionnels de 180 mm. Manche polypropylène creux.



∅ tige mm	Ref.	
8	861310	1

## MONTURE AUTOBLOQUANTE MANCHE POLYPROPYLENE

Sans vis ni butée. Tige galvanisée. Pour manchons à clips de 180 mm. Manche polypropylène creux.



∅ tige mm	Ref.	
8	861320	1

## MONTURE RADIATEUR AUTOBLOQUANTE MANCHE POLYPROPYLENE

Sans vis ni butée. Tige galvanisée. Pour manchons radiateur à clips de 110 mm. Manche polypropylène creux.



L cm	∅ tige mm	Ref.	
29	6	861350	1
39	6	861360	1

## CAMION PLASTIQUE

Gradué.



Contenance L	Largeur max mm	Ref.	
7	252	101830	1

## BAC PLASTIQUE PLAT POUR ROULEAUX DE 110 MM



Ref.	
101770	1

## BAC PLASTIQUE PLAT POUR ROULEAUX DE 180 MM



Ref.	
101780	1

## GRILLE MÉTAL POUR ROULEAUX DE 180 MM



L x l mm	Ref.	
245 x 195	101790	1

## AUGETTE À RACCORDS

En polyéthylène. Idéale lors de la réalisation de raccords.



L x l x H mm	Capacité L	Ref.	
320 x 220 x 70	3	101800	1

## SUPPORT DE PINCEAU

Permet le maintien et l'égouttage du pinceau. En matière plastique. Se fixe sur la partie intérieure du pot de peinture.



Ref.	
101450	1



16



62



96



120



126



156



188



224



248



254



300



316



340



390



462



488



441

## CHARIOT PORTE-SEAU



**TMS**

### + LES PLUS

- Prévient les maladies professionnelles (plus besoin de se baisser)
- Facilement déplaçable grâce aux roues
- Pratique pour le travail en hauteur
- Rapidement réglable grâce aux goupilles clips.
- Porte-seau, pot de peinture...
- Réglable pour 4 dimensions de seaux : Ø 435 mm - Ø 340 mm - Ø 300 mm - Ø 270 mm.
- Charge : 50 kg.
- 4 roues Ø 100 mm (dont 2 équipées de système de freinage).



### CHARIOT PORTE-SEAU PLIABLE

Chariot porte-seau, pots de peintures...



(Seau vendu séparément)



H mm	Charge maximum kg	kg	Ref.	☐
710	50	7,7	156430	1

## SUPPORT DE VOILETS PEINTURE

### + LES PLUS

- Pour peindre en une seule fois 3 paires de volets



### CARACTÉRISTIQUES

- Gonds réglables pour suspendre des volets de toutes dimensions : fenêtres, porte-fenêtres et persiennes
- Faible empattement facilitant la mise en oeuvre sur tous les chantiers, y compris les chantiers encombrés
- Rangement facile
- Grande stabilité même avec une seule paire de volets



### SUPPORT DE VOILETS

3 paires de volets à peindre en une fois.



Empattement au sol m	kg	Ref.	☐
1,15 x 0,93	19,4	116010	1

# PEINTRE C'EST AUSSI...

PLATOIR DEUX MAINS LAME  
INOX TREMPÉ BISEAUTÉ 0,6 MM

>> PAGE 465

Ref.	
232031	3



PLATOIR LAME INOX  
TREMPÉ BISEAUTÉ

>> PAGE 464

Ref.	
231031	3



PLATOIR MONTURE ALU  
LAME INOX 0,6 MM

>> PAGE 464

Ref.	
234521	3



COUPEAU À ENDUIRE  
LAME INOX

>> PAGE 470

Ref.	
223380	6



COUPEAU À MASTIQUER  
MANCHE BOIS

>> PAGE 479

Ref.	
224870	5



COUPEAU DE PEINTRE  
LAME ACIER MANCHE BOIS

>> PAGE 479

Ref.	
220040	5



COMBINAISON  
POLYPROPYLENE AÉRÉE

>> PAGE 504

Ref.	
801630	1



TRÉTEAU PLIANT  
"PROFESSIONNEL"

>> PAGE 314

Ref.	
113000	2



DÉCOUPE THERMIQUE

>> PAGE 507

Ref.	
862010	1



TOILE ÉMERI

>> PAGE 507

Ref.	
101970	10



PLATEFORME  
NINJA

>> PAGE 312

Ref.	
500610	1



STUCATEUR INOX

>> PAGE 487

Ref.	
6072990404	1



HACHETTE  
PLÂTRIER

>> PAGE 281

Ref.	
0436000701	1

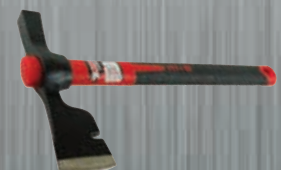



# CARRELEUR : COUPE, CARREAUX

## COUPE-CARREAUX BASIC PLUS

### + LES PLUS

- Le chariot en technopolymère IXEF® garanti 5.000.000 de coupes
- Facile d'entretien : pas de lubrification
- Pas de maintenance (les barres en acier chromé sont très résistantes)



Valise de transport



Couper et séparer  
La coupe se fait en poussant, avec la possibilité de casser le carreau en tout point.

#### PROFILÉ OVAL

Le chariot coulisse sur 2 profils en acier chromé qui lui assurent une très grande rigidité.

#### CHARIOT

Le chariot coulissant est fabriqué en technopolymère IXEF® de haute résistance

#### AVANTAGES :

- Le coulissement n'est sujet à aucun frottement, donc est très facile et rapide.
- Pas de risque de colmatage.
- Aucun risque de rouille.



#### SÉPARATEUR

La grande taille du séparateur permet de diviser les 2 parties du carreau très facilement.

#### MOLETTE DE COUPE

Molette au carbure de tungstène de Ø 15 mm.

#### RÈGLE

Il est possible de régler la coupe diagonale de 0 à 45°. Règle graduée en cm.

### COUPE-CARREAUX BASIC PLUS 40

Longueur de coupe : 40 cm.  
Coupe diagonale : 28 x 28 cm.  
Valise de transport en plastique.



### COUPE-CARREAUX BASIC PLUS 60

Longueur de coupe : 60 cm.  
Coupe diagonale : 42 x 42 cm.  
Valise de transport en plastique.



Longueur de coupe cm	Coupe diagonale cm	Epaisseur de coupe mm	Dim. molette mm	kg	Ref.	1
40	28 x 28	4 - 12	Ø 15 x 6 x 1,5	3,50	155500	1

Longueur de coupe cm	Coupe diagonale cm	Epaisseur de coupe mm	Dim. molette mm	kg	Ref.	1
60	42 x 42	4 - 12	Ø 15 x 6 x 1,5	4,40	155510	1

### MOLETTE DE RECHANGE BASIC PLUS

Ø mm	Ref.	1
15	155560	1



# CARRELEUR : COUPE, CARREAUX



## COUPE-CARREAUX ULTRA

### + LES PLUS

- Équerre de coupe intégrée
- Le chariot en technopolymère IXEF® garanti 5.000.000 de coupes
- Facile d'entretien : pas de lubrification
- Pas de maintenance (les barres en acier chromé sont très résistantes)



#### CHARIOT

Le chariot coulissant permet de couper les carreaux en tout point. La poignée permet de réduire l'effort.

L'équerre de coupe  
Elle peut être utilisée de  $-45^\circ$  à  $+45^\circ$ .  
Fournie avec échelle métrique double, pour une lecture directe des mesures de coupes droites et diagonales.



**PLAN DE TRAVAIL**  
Fabriqué en acier et amorti par une couche de mousse.

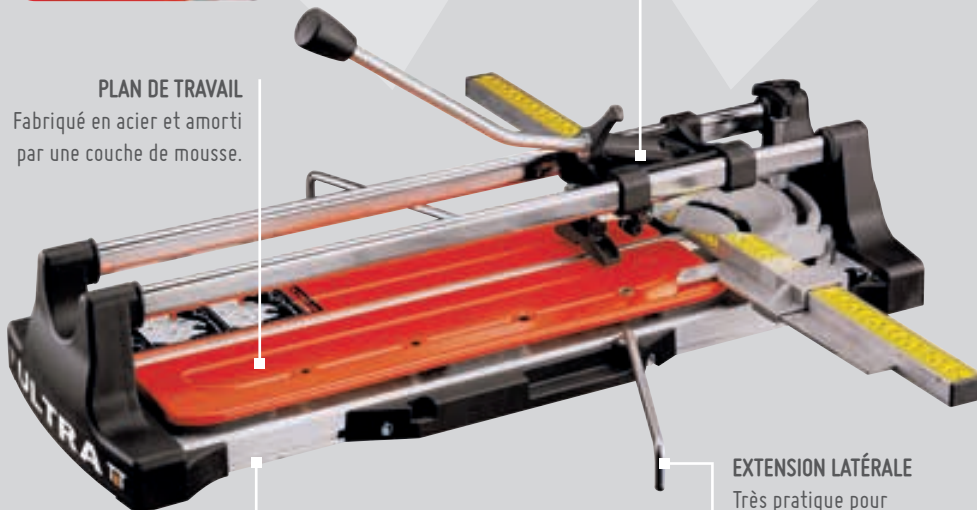

#### STRUCTURE

La structure est fabriquée dans un profil aluminium, pour un outil très résistant et léger.

#### EXTENSION LATÉRALE

Très pratique pour couper les carreaux de grand format.

Pour une lecture directe de la mesure sur les coupes droites, positionner l'équerre de coupe à  $90^\circ$ .



### COUPE-CARREAUX ULTRA 40

Carrelage dur.  
Longueur de coupe : 42 cm.  
Coupe diagonale : 30 x 30 cm.  
Valise de transport en plastique.



Longueur de coupe cm	Coupe diagonale cm	Épaisseur de coupe mm	Dim. molette mm	kg	Ref.	📦
42	30 x 30	5-15	Ø 15 x 6 x 1,5	11,5	155520	1

### COUPE-CARREAUX ULTRA 60

Carrelage dur.  
Longueur de coupe : 60 cm.  
Coupe diagonale : 42 x 42 cm.  
Valise de transport en plastique.



Longueur de coupe cm	Coupe diagonale cm	Épaisseur de coupe mm	kg	Ref.	📦
60	42 x 42	5-15	12,5	155530	1

### MOLETTE DE RECHANGE ULTRA

Ø mm	Ref.	📦
15	155560	1



16



62



96



120



126



156



188



224



248



254



300



316



340



390



462



488

488

445

# CARRELEUR : COUPE DE CARREAUX

## COUPE-CARREAUX SUPER PRO

### + LES PLUS

- Conçu pour couper le carrelage le plus dur
- Très robuste
- 9 roulements à billes pour une excellente précision de coupe
- Longueur de coupe de 75 cm et 90 cm
- Facile d'utilisation



#### CHARIOT

Le chariot coulissant comporte 9 roulements à billes, dont 4 réglables pour assurer un glissement parfait et une très grande précision.

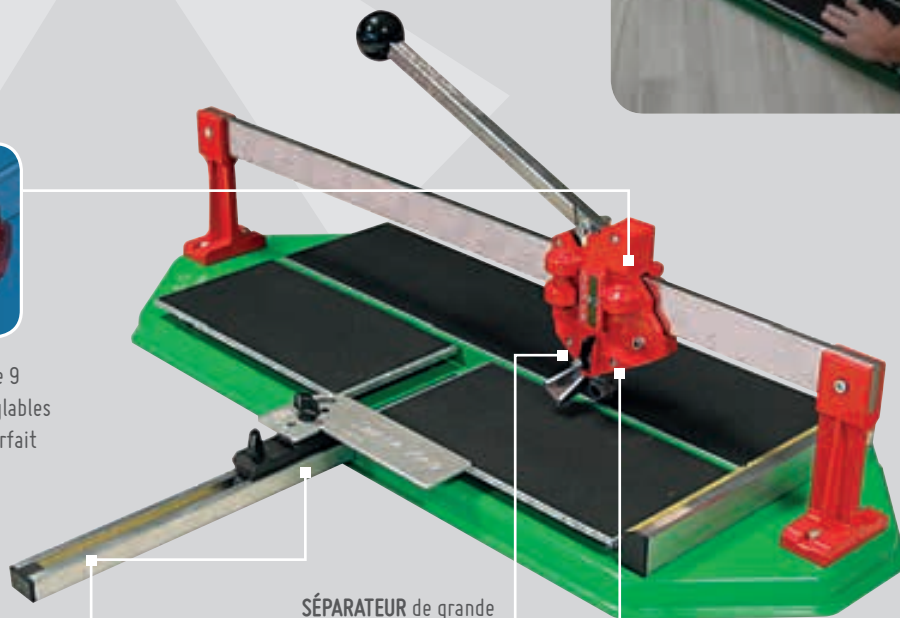

#### COUPES DROITES ET DIAGONALES

Très rapide et précise. L'équerre latérale permet une lecture directe tant dans les coupes droites que diagonales.

SÉPARATEUR de grande dimension permettant de couper les carreaux en tout point.



#### MOLETTE DE COUPE

Molette au carbure de tungstène de Ø 22 mm.



### COUPE-CARREAUX SUPER PRO 750

Très robuste conçu pour couper le carrelage le plus dur.  
Longueur de coupe : 75 cm.  
Coupe diagonale : 52 x 52 cm.



Longueur de coupe cm	Coupe diagonale cm	Épaisseur de coupe mm	Ø molette mm	kg	Ref.	📦
75	52 x 52	5 - 19	22 x 6,1 x 4,7	19	155540	1

### COUPE-CARREAUX SUPER PRO 900

Très robuste conçu pour couper le carrelage le plus dur.  
Longueur de coupe : 90 cm.  
Coupe diagonale : 63 x 63 cm.



Longueur de coupe cm	Coupe diagonale cm	Épaisseur de coupe mm	Ø molette mm	kg	Ref.	📦
90	63 x 63	5 - 19	22 x 6,1 x 4,7	22	155550	1

### MOLETTE DE RECHANGE SUPER PRO

Ø mm	Ref.	📦
22	155570	1





# CARRELEUR : COUPE DE CARREAUX



## CRAYON MINE BLANCHE

Pour le marquage sur les carreaux foncés (noirs, gris, taupe...).



Ref.		Carte de 2	
811120	12	811128	1

## POINTE À TRACER

Avec boule plastique de protection, à dévisser pour libérer la pointe.



Ref.	1
155858	1

## GABARIT DE FORME

Permet de reporter des tracés de coupes aux contours difficiles à mesurer et reproduire.



L cm	Amplitude des lamelles cm	Ref.	1
25	3	153550	1

## PINCE COUPE-CARREAUX

Avec molette au carbure de Tungstène Ø 14 mm.



Ref.	1
155808	1

## TENAILLE DE CARRELEUR

Bec perroquet.



L cm	Ref.	1
20	155840	1

## PINCE DE MOSAÏSTE

En carbure de tungstène



L mm	g	Ref.	1
200	340	155878	1

## PINCE MULTICOUPE

Pour coupe à onglet des moulures bois, profilés PVC pour carreleurs.



Ref.	1
503258	1

Boîte de 10 lames de rechange forme trapèze, pour pince multicoupe	Ref.	1
	503268	1

## PERCE-CARREAUX GRADUÉ

Avec pointe et lame au carbure de Tungstène interchangeables. Queue ronde. S'adapte sur perceuse. Ø minimum de perçage : 26 mm. Ø maximum de perçage : 100 mm.



Ref.	1
155828	1

## SCIE VILEBREQUIN POUR CARRELEUR

Avec lame ronde au carbure de Tungstène.



L cm	Ref.	1
30	833150	1

Lames de rechange x 4	Ref.	1
	833168	1

## SCIE TRÉPAN AU CARBURE DE TUNGSTÈNE

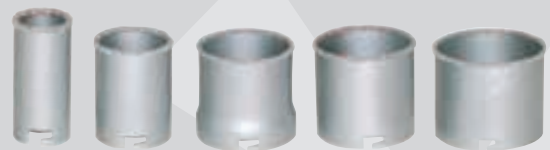

Ø 33 mm	Ø 53 mm	Ø 67 mm	Ø 73 mm	Ø 83 mm
833330	833350	833360	833370	833380



Support aluminium  
833400



Foret centreur au carbure de Tungstène  
833410

## SCIE TRÉPAN AU CARBURE DE TUNGSTÈNE



Ø mm	Ref.	1
33	833330	1
53	833350	1
67	833360	1
73	833370	1
83	833380	1

	Ref.	1
Support aluminium	833400	1
Foret centreur au carbure de Tungstène	833410	1

## COFFRET DE SCIES TRÉPANS AU CARBURE DE TUNGSTÈNE

5 trépan Ø 33, 53, 67, 73 et 83 mm + 1 support aluminium + 1 foret carbure + 1 lime



Nb pièces x 8	Ref.	1
	833320	1



16



62



96



120



126



156



188



224



248



254



300



316



340



390



462



488



## POSE-DALLES



### + LES PLUS

- Facilite la manutention des dalles : permet de déposer les dalles directement et précisément à leur emplacement, en toute sécurité
- Poignée ergonomique pour une meilleure prise en main

### CARACTÉRISTIQUES

- Réglage tous les 16 mm
- Indexation fixe.



## POSE-DALLES

Aide à la pose des dalles.  
Réglage tous les 16 mm.



Longueur dalle cm	Charge utile kg	Ref.	
30 > 50	40	153000	1
30 > 70	50	153020	1

## CHARIOT DE MANUTENTION



### + LES PLUS

- Plateforme en contreplaqué antidérapant 375 x 410 mm
- Charge utile : 120 Kg
- Transport facile
- Lutte contre les maladies professionnelles
- 4 roulettes multidirectionnelles

### UTILISATION

- Pour la manutention des paquets de carreaux, sac de ciment, plâtre, colle...



## CHARIOT DE MANUTENTION

Charge utile : 120 Kg.



Longueur plate-forme mm	Largeur plate-forme mm	Charge utile kg	Ref.	
410	375	120	156400	1

## VENTOUSE SIMPLE

Pour la pose ou la dépose des carreaux.



Ø mm	Force utile kg	Ref.	
80	11	153700	1



## DOUBLE VENTOUSE

### + LES PLUS

- Double tête en caoutchouc pour une capacité élevée de 80 kg
- Verrouillage par 2 leviers oscillants, pour une grande fiabilité



### UTILISATION

- Ventouse de transport double
- Permet de lever les grands carreaux avec facilité
- Idéal pour le transport d'objets lourds ayant peu de prise.

### PERFORMANCE

- Adhérence totale, même avec de la poussière
- Capacité : 80kg
- Diamètre de chaque ventouse : 120mm

### CARACTÉRISTIQUES

- Base en aluminium
- Finition peinte grise
- Semelles en caoutchouc
- Longueur totale : 330mm

## DOUBLE VENTOUSE

Permet de lever carreaux, panneaux et vitres de surfaces planes. Ventouse de transport en caoutchouc double. Diamètre de chaque ventouse : 120mm. Capacité : 80kg. Verrouillage par 2 leviers oscillants



Ø mm	Force utile kg	Ref.	📦
120	80	153690	1

## BATTE HÊTRE SEMELLE CAOUTCHOUC

En contreplaqué hêtre semelle caoutchouc épaisseur 3 mm



Dimensions cm	Ref.	📦
14 x 36	163360	1

## BATTE SAMBA

Bois samba massif.



Dimensions cm	Ref.	📦
12 x 40	164380	1
12 x 40 semelle caoutchouc 3 mm	164390	1
12 x 30	164340	1
12 x 30 semelle caoutchouc 3 mm	164350	1

## EQUERRE 45°

Facilite la pose du carrelage en diagonale.  
Profil aluminium. 50 x 15 mm.  
2 angles à 45°,  
1 angle à 90°.



Dimensions cm	Ref.	📦
100 x 100 x 140	350140	2

## MINI-RÈGLE ALU 50 X 15 MM

Livrée avec embouts plastiques.



L m	l mm	E mm	Ref.	📦
1,25	50	15	354125	1
1,50	50	15	354150	1
1,75	50	15	354175	1
2	50	15	354200	1
2,50	50	15	354250	1
3	50	15	354300	1
4	50	15	354400	1
5	50	15	354500	1
6	50	15	354600	1

## RÈGLE ALU DE CARRELEUR 65 X 25 MM

Livrée avec embouts plastiques.



L m	l mm	E mm	Ref.	📦
1,25	65	25	354712	1
1,50	65	25	354715	1
2	65	25	354720	1
2,50	65	25	354725	1
3	65	25	354730	1
4	65	25	354740	1
5	65	25	354750	1
6	65	25	354760	1

## RÈGLE DE CARRELEUR POUR CHAPE

Lame inox.



Dimensions cm	Épaisseur mm	Ref.	📦
200 x 6	0,6	103100	2



16



62



96



120



126



156



188



224



248



254



300



316



340



390



462



488



## GENOUILLÈRES GEL PRO

### + LES PLUS

TMS



- Amorti parfait pour un usage intensif.
- Ne laisse pas de traces sur les carreaux.
- S'adapte à vos mouvements.

### DOUBLE ATTACHE

- Fixation rapide par lanière élastique avec velcro
- Ou enfilage par le pied avec une bande stretch aérée et large de 4,5 cm.

### NORME

- Certifié conforme à la norme NF EN 14404:2004 **CE**
- Genouillères GEL 6193 de niveau 1 ; convient à toute condition normale de travail.
- Taille XL. Tour de taille de l'utilisateur : 125cm

### RÉSISTANCE

- Pas de fuite de gel : gel technique injecté en nid d'abeille. Non altéré de 0° à +50°C
- Élastomère d'approche isotherme.
- Forte épaisseur de mousse de copolymère, fermée haute densité.
- Textile robuste : nylon de 1680 deniers.



### GENOUILLÈRES GEL PRO

Gel technique injecté en nid d'abeille.  
Double attache.  
Conforme à la norme EN 14404. CE. La paire.

CE



Ref.	
154140	1

### GENOUILLÈRES GEL

Genouillères de protection avec rembourrage gel. Revêtement antidérapant. Maintien par 2 sangles élastiques de 65 mm de large pour éviter de couper la circulation sanguine. Certifiées conformes DIN EN 14404. La paire.



Ref.	
154130	1

### GENOUILLÈRES POLYURÉTHANE JAUNE

Construction renforcée par la présence d'une plaque à l'intérieur de la genouillère. Sangle réglable. DIN EN 14404-2004. La paire.

CE



Ref.	
154150	1

### PATINS DE CARRELEUR PLASTIQUE LISSE

Semelle lisse bleue. La paire.



Dimensions mm	Ref.	
398 x 200	154080	1

### PATINS DE CARRELEUR PLASTIQUE STRIE

Semelle striée noire. La paire.



Dimensions mm	Ref.	
398 x 200	154090	1

>> Voir famille E.P.I.



## ERGOLAME® CARRELEUR

ERGOLAME®

### UTILISATION

- Pour l'encollage des carreaux et faïence.
- Un geste facilité grâce à sa poignée ergonomique et sa lame dégagée.

### CARACTÉRISTIQUES

- lame interchangeable.
- lame inox dentée 120 mm, épaisseur 0,6 mm.



227700  
6x6



227710  
10x10

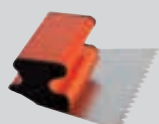

227720  
8x9



227800  
6x6



227830  
8x8

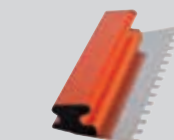

227810  
10x10



227840  
1/2 rond



227820  
8x9

### ERGOLAME® CARRELEUR 15 CM

Pour l'encollage des carreaux et faïences.  
Lame inox.



Denture mm	L mm	Ref.	☐
Dents carrées 6 x 6 x 6	150	227700	2
Dents carrées 10 x 10 x 10	150	227710	2
Dents larges pointues 8 x 9	150	227720	2

### ERGOLAME® CARRELEUR 30CM

Pour l'encollage des carreaux et faïences.  
Lame inox.



Denture mm	L mm	Ref.	☐
Dents carrées 6 x 6 x 6	300	227800	2
Dents carrées 8 x 8 x 8	300	227830	2
Dents carrées 10 x 10 x 10	300	227810	2
Dents larges pointues 8 x 9	300	227820	2
Dents 1/2 rondes Ø 20	300	227840	2

### LAME ERGOLAME® CARRELEUR

Changement simple avec une clé mâle inclus dans l'outil.

Denture mm	L mm	Ref.	☐
Dents carrées 6 x 6 x 6	150	227701	1
Dents carrées 6 x 6 x 6	300	227801	1
Dents carrées 10 x 10 x 10	150	227711	1
Dents carrées 10 x 10 x 10	300	227811	1
Dents carrées 8 x 8 x 8	300	227831	1
Dents pointues 8 x 9	150	227721	1
Dents pointues 8 x 9	300	227821	1
Dents 1/2 rondes Ø 20	300	227841	1



## SEAU DE CARRELEUR

- 14 et 16 L évasés ou seau à veau
- Poignée plastique.



## SEAU PLASTIQUE DE CARRELEUR

14 et 16 L évasé ou seau à veau.



Capacité L	Couleur	Ø anse mm	Ref.	📦
14	noir	6,3	341040	10
16	noir	6,3	341030	10

## SEAU PLASTIQUE DE CARRELEUR AVEC POIGNÉE

14 et 16 L évasé ou seau à veau. Poignée plastique.



Capacité L	Couleur	Ø anse mm	Ref.	📦
16	noir	5,3	341031	10
16	rouge	5,3	341032	10

## TRUELLE CARRÉE DE CARRELEUR

Manche en bois sans culot pour l'ajustement des carreaux. Acier trempé.



L cm	Ref.	📦
16	334160	1

## PEIGNE À COLLE 4 EN 1

### UTILISATION

- 1 seul outil pour l'encollage des carreaux de 10 x 30 cm à 60 x 60 cm double encollage

### CARACTÉRISTIQUES

- 4 côtés différents : dents fines pointues 2,5 x 4 mm, dents carrées 10 x 10 x 10 mm, dents carrées 8 x 8 x 8 mm, dents carrées 6 x 6 x 6 mm.
- En plastique injecté ABS



## PEIGNE À COLLE 4 EN 1

- 4 Dentures différentes :
- Dents carrées 6x6x6 mm
  - Dents carrées 8x8x8 mm
  - Dents carrées 10x10x10 mm
  - Dents pointues isocèles 2,5x4 mm



Ref.	📦
225100	1



## KIT PEIGNES À COLLE 6 DENTURES

### UTILISATION

- Pour l'encollage des carreaux de 10 x 30 cm à 60 x 60 cm simple encollage.
- Très compact pour une variété d'utilisation 6 en 1.
- Lames interchangeable et réversibles.
- 3 lames / 6 dentures :
  - 1 lame denture pointue 8x9mm et denture carrée 6x6x6 mm
  - 1 lame denture carrée 8x8x8 mm et 10x10x10mm
  - 1 lame denture carrée 12x12x12mm et denture 1/2 ronde
- Poignée plastique pour protection de la main lors de la pose.
- Poignée en 2 demi-coques.
- Lames interchangeables grâce à la clé de démontage incluse sur le côté de la poignée.
- Lames en acier.



## KIT PEIGNES À COLLE 6 DENTURES

- 3 lames / 6 dentures :
  - 1 lame denture pointue 8x9mm et denture carrée 6x6x6 mm
  - 1 lame denture carrée 8x8x8 mm et 10x10x10mm
  - 1 lame denture carrée 12x12x12mm et denture 1/2 ronde



Ref.	Quantité
225201	1

## SPATULE À COLLE MANCHE BIMATIÈRE

### UTILISATION

- Pour l'encollage de carreaux.

### LES PLUS

- Manche bimatière toucher «SOFT» pour une excellente prise en main et une longévité accrue
- Lame acier verni haute qualité
- Monture avec trou d'accrochage



## SPATULE À COLLE MANCHE BI-MATIÈRE 20 CM

Lame acier verni.  
Manche avec trou d'accrochage.



Denture mm	L mm	Ref.	Quantité
Dents carrées 2,5 x 2,5 x 4	200	224941	5
Dents carrées 6 x 6 x 6	200	224921	5
Dents carrées 10 x 10 x 10	200	224961	5
Dents larges pointue 7 x 5	200	224951	5
Dents fines pointues 2,5 x 4	200	224931	5

## SPATULE À COLLE MANCHE BI-MATIÈRE 30 CM

Lame acier verni.  
Manche avec trou d'accrochage.



Denture mm	L mm	Ref.	Quantité
Dents carrées 6 x 6 x 6	300	224991	5
Dents carrées 10 x 10 x 10	300	225001	5

## SPATULE À COLLE MANCHE BOIS 20 CM

Lame acier verni.  
Monture bois avec trou d'accrochage.



Denture mm	L mm	Ref.	Quantité
Dents carrées 2,5 x 2,5 x 4	200	224940	5
Dents carrées 6 x 6 x 6	200	224920	5
Dents carrées 10 x 10 x 10	200	224960	5
Dents larges pointues 7 x 5	200	224950	5
Dents fines pointues 2,5 x 4	200	224930	5

## SPATULE À COLLE MANCHE BOIS 30 CM

Lame acier verni.  
Monture bois avec trou d'accrochage.



Denture mm	L mm	Ref.	Quantité
Dents carrées 6 x 6 x 6	300	224990	5
Dents carrées 10 x 10 x 10	300	225000	5



16



62



96



120



126



156



188



224



248



254



300



316



340



390



462



488



453



# CARRELEUR : CROISILLONS

## CROISILLONS

Une large gamme de croisillons, disponibles en sachets brochables.



## CROISILLONS POUR PIERRES ET BRIQUES

Polystyrène. Pour joints de 15 et 20 mm. Réversibles et récupérables.



Blister

Nb de pièces	Ref.	
15	151120	1

## CROISILLON-ÉCARTEUR CARRELAGE ET FAÏENCE

Permet de respecter un écartement parfait entre les carreaux avant la pose du joint.

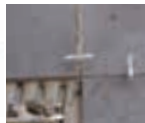

Dimensions mm	Nb de pièces	Ref.	
1	250	151010	1
1,5	250	151000	1
2	250	151020	1
2	500	151025	1
2 forme "T"	250	151022	1
3	250	151030	1
3 forme "T"	200	151032	1
3	500	151035	1
4	250	151040	1
4	500	151045	1
5	250	151050	1
5	500	151055	1
6	100	151060	1
8	100	151080	1

## CROISILLON-ÉCARTEUR LONG

Permet de respecter un écartement parfait entre les carreaux avant la pose du joint. Longueur : 40 mm. Rigide et ajouré.



Sachet			
Dimensions mm	Nb de pièces	Ref.	
3	200	151430	1
4	200	151440	1

## CROISILLONS RÉCUPÉRABLES

Chaque croisillon est muni d'une languette qui permet de le récupérer.



Sachet			
Dimensions mm	Nb de pièces	Ref.	
1,5	100	151310	1
2	100	151320	1
3	100	151330	1
4	100	151340	1
5	100	151350	1

## COINS DE CARRELEUR

Pour la pose de carreaux non calibrés.



Sachet

Nb de pièces	Ref.	
250	152000	1

## JOINT PÉRIPHÉRIQUE

- Pour isoler et compenser la dilatation des dalles.
- Mousse polyéthylène expansé 5 mm.

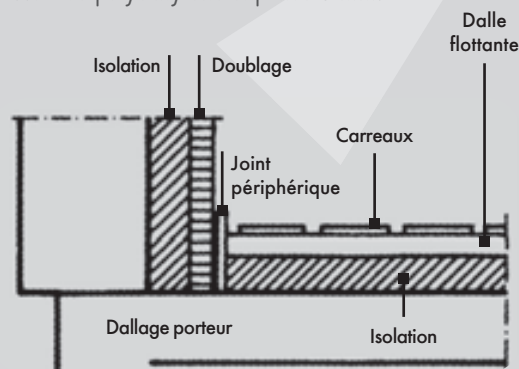

## JOINT PÉRIPHÉRIQUE

Pour isoler et compenser la dilatation des dalles. Mousse polyéthylène expansé 5 mm.



Largeur cm	Longueur m	Épaisseur mm	Nb bandes par sac	Ref.	
8	50	5	15	153080	1
10	50	5	12	153100	1
15	50	5	8	153090	1





## PROJOINT® 30 L PROFESSIONNEL



### + LES PLUS

- Une grille amovible pour faciliter le nettoyage
- Un système anti-vagues qui évite à l'eau de déborder lors des déplacements du kit
- 4 roulettes multidirectionnelles avec freins
- Rouleaux amovibles pour faciliter le nettoyage
- Poignée ergonomique avec une bonne prise en main
- Un bac lisse pour un nettoyage rapide
- Bec verseur
- Design issu de la collaboration entre notre bureau d'études et notre designer

## PROjoint®



### UTILISATION

- Pour le jointoiment et le nettoyage des surfaces de carrelage.

Position du plateau verticale



Position du plateau horizontale



Position optimisée des roulettes pour éviter l'écoulement d'eau sur le sol lors de l'essorage



Bec verseur



Grille amovible munie d'un système anti-vagues



Bac lisse pour un nettoyage facile



Testé et approuvé par nos artisans partenaires



### PROJOINT® 30 L PROFESSIONNEL

Pour le jointoiment et le nettoyage des surfaces importantes de carrelage.

Composition :

- Bac plastique de 30L sur roulettes : capacité utile 13L
- Grille plastique alvéolée amovible
- Ensemble amovible de 3 rouleaux d'essorage
- Platoir à jointer 29 x 14 cm (Réf.152710)
- Platoir à nettoyer 29 x 14 cm (Réf.152730).



Capacité bac L	Ref.	
30	156200	1



16



62



96



120



126



156



188



224



248



254



300



316



340



390



462



488



# CARRELEUR : KITS À JOINTS

## EASYJOINT 17L



### + LES PLUS

- Ensemble amovible de 2 rouleaux pour faciliter l'essorage du platoir à nettoyer
- Un système anti-vagues pour éviter le débordement ou l'écoulement d'eau sur le sol lors des déplacements du bac
- Pratique à transporter avec la poignée
- Facile à nettoyer

### UTILISATION

- Pour le jointoiment et le nettoyage de petites surfaces de carrelage.



### EASYJOINT 17L

Pour le jointoiment et le nettoyage de petites surfaces de carrelage.

Bac 17L : capacité utile 7L

- Ensemble amovible de 2 rouleaux d'essorage

- Platoir à jointer monobloc 25 x 14 cm, semelle caoutchouc noir, épaisseur 8 mm

- Platoir à nettoyer monobloc 25 x 14 cm, mousse jaune, épaisseur 30 mm.



Capacité bac L	Ref.	
17	156300	1

### NÉCESSAIRE À JOINT

Pour la réalisation et le nettoyage des joints. Composition du kit :

- Platoir à jointer monobloc 14 x 25 cm semelle caoutchouc noir 8 mm.
- Platoir à nettoyer monobloc mousse jaune épaisseur 30 mm 14 x 25 cm.
- Eponge ovale 15 x 11 x 5,8 cm



Vendu dans une boîte carton



Ref.	
156050	1



## DECOJOINT®

- Joints colorés chargés en résine
- Mélange prêts à l'emploi
- Pour tout type de carrelages : sols, murs intérieurs et extérieurs : cuisines, salles de bain, piscines...
- Joints de 1 à 10 mm
- 3 conditionnements :
  - pot 1 kg / pot 3 kg
  - seau 15 kg
- Conforme au DTU 52.1

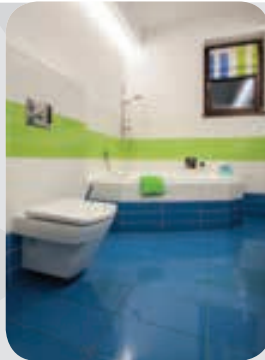

### Tableau de rendement du Decojoint® en kg/m<sup>2</sup>

Ces valeurs en kg sont données à titre indicatif et varient en fonction de l'épaisseur des carreaux.

Largeur des joints mm	Dimensions des carreaux					
	5x5	10x10	15x15	20x20	30x30	40x40
2	0,60	0,50	0,30	0,25	0,20	-
3	1,4	0,75	0,50	0,40	0,30	-
5	1,5	1,25	0,80	0,60	0,40	-
6	2,6	1,45	1	0,85	0,75	0,65
10	-	-	-	1,85	1,35	1

### Couleurs «ÉCLAT»



### Couleurs «PASSION»



### DECOJOINT® POT DE 1 KG COULEUR PASSION

Couleur	kg	Ref.	📦
Tourterelle	1	171010	3
Gris pierre	1	171020	3
Gris argent	1	171030	3
Sable	1	171040	3
Paille	1	171050	3
Ivoire	1	171060	3
Tilleul	1	171070	3
Moutarde	1	171080	3
Noisette	1	171090	3

Couleur	kg	Ref.	📦
Azur	1	171100	3
Bleuet	1	171110	3
Dragée	1	171120	3
Ébène	1	171130	3
Havane	1	171140	3
Pêche	1	171150	3
Lys	1	171160	3
Tuile	1	171170	3
Mange	1	171180	3



16



62



96



120



126



156



188



224



248



254



300



316



340



390



462



488



# CARRELEUR : DECOJOINT®

## DECOJOINT® POT DE 3 KG COULEUR PASSION



Couleur	kg	Ref.	☐
Tourterelle	3	171011	2
Gris pierre	3	171021	2
Gris argent	3	171031	2
Sable	3	171041	2
Paille	3	171051	2
Ivoire	3	171061	2
Tilleul	3	171071	2
Moutarde	3	171081	2
Noisette	3	171091	2
Azur	3	171101	2
Bleuet	3	171111	2
Dragée	3	171121	2
Ébène	3	171131	2
Havane	3	171141	2
Pêche	3	171151	2
Lys	3	171161	2
Tuile	3	171171	2
Mangue	3	171181	2

## DECOJOINT® SEAU DE 15 KG COULEUR PASSION



Couleur	kg	Ref.	☐
Tourterelle	15	171012	1
Gris pierre	15	171022	1
Gris argent	15	171032	1
Sable	15	171042	1
Paille	15	171052	1
Ivoire	15	171062	1
Tilleul	15	171072	1
Moutarde	15	171082	1
Noisette	15	171092	1
Azur	15	171102	1
Bleuet	15	171112	1
Dragée	15	171122	1
Ébène	15	171132	1
Havane	15	171142	1
Pêche	15	171152	1
Lys	15	171162	1
Tuile	15	171172	1
Mangue	15	171182	1

## DECOJOINT® POT DE 1 KG COULEUR ÉCLAT



Couleur	kg	Ref.	☐
Corail	1	171300	3
Lilas	1	171310	3
Jade	1	171320	3
Bouton d'or	1	171330	3
Vermeil	1	171340	3
Lavande	1	171350	3
Saphir	1	171360	3
Fuchsia	1	171370	3
Chocolat	1	171380	3

## DECOJOINT® POT DE 3 KG COULEUR ÉCLAT



Couleur	kg	Ref.	☐
Corail	3	171301	2
Lilas	3	171311	2
Jade	3	171321	2
Bouton d'or	3	171331	2
Vermeil	3	171341	2
Lavande	3	171351	2
Saphir	3	171361	2
Fuchsia	3	171371	2
Chocolat	3	171381	2

## DECOJOINT® SEAU DE 15 KG COULEUR ÉCLAT



Couleur	kg	Ref.	☐
Corail	15	171302	1
Lilas	15	171312	1
Jade	15	171322	1
Bouton d'or	15	171332	1
Vermeil	15	171342	1
Lavande	15	171352	1
Saphir	15	171362	1
Fuchsia	15	171372	1
Chocolat	15	171382	1

## BOUCHE PORES

Forme en surface un film protecteur qui évite l'incrustation des couleurs et facilite le nettoyage. Convient également pour imperméabiliser les couleurs ciment. 1 litre permet de traiter en deux couches, environ 20 m2 de carrelage.



Capacité L	Ref.	☐
1	170900	1

## FIXATEUR DE JOINTS

Renforce et stabilise la tenue des joints colorés de carrelage. Évite leur encrassement. Indispensable sur les sols et toutes surfaces fortement sollicitées ou fréquemment soumises aux produits nettoyants (cuisines, plans de travail, salles de bain...).



Capacité L	Ref.	☐
0,5	170910	1



## RACLETTE DE FAÏENCIER

### UTILISATION

- Pour la finition des joints de faïence.

### CONFORT

- Poignée ergonomique en polystyrène pour un meilleur confort de travail.

### QUALITÉ

- Caoutchouc dur rouge.

### CARACTÉRISTIQUES

- Longueur 28 cm.



## RACLETTE DE FAÏENCIER

Poignée ergonomique en polystyrène pour un meilleur confort de travail. Caoutchouc dur rouge.



L cm	Ref.	☐
28	161300	1

## RACLETTE MÉTALLIQUE MOUSSE DOUBLE

Métal bi-chromaté.



L cm	Ref.	☐
44	161400	6

## RACLETTE MÉTALLIQUE MOUSSE DOUBLE À CORNIÈRE

Métal bi-chromaté avec cornière de renfort.



L cm	Ref.	☐
55	161410	6
75	161420	6

## RACLETTE BOIS AVEC DOUILLE ACIER

Mousse double.



L cm	Ref.	☐
70	161150	6
100	161140	6

## RACLETTE BOIS 44 CM



	L cm	Ref.	☐
Mousse double	44	161200	6
Caoutchouc dur rouge	44	161220	6

## DOUILLE PLASTIQUE AVEC VIS

S'adapte sur les raclettes bois de 44 cm. Permet un meilleur maintien du manche.



Ref.	☐
161230	1

## MANCHE POUR RACLETTE 1,20 M

Manche à balai standard. Pour raclette bois de 44 cm et raclettes métal de 44, 55 et 75 cm.



L m	∅ mm	Ref.	☐
1,20	24	161240	12

## MANCHE POUR RACLETTE 1,40 M

Manche à balai standard. Pour raclette bois de 70 cm et 100 cm avec douille.



L m	∅ mm	Ref.	☐
1,40	28	161260	12



16



62



96



120



126



156



188



224



248



254



300



316



340



390



462



488



488

459

## NÉCESSAIRE À JOINTS

Contenu : 1 poche à joints en toile polyester recouverte de PVC sur les 2 faces, avec 1 embout spécial faïence.  
2 sachets-doses d'adjuvant "JOINT +". Grâce à cet adjuvant, la poche permet l'injection de tout type de mortiers pour joints de brique, pierre, carrelage, faïence...



Ref.		
302420		1

## POCHE À JOINTS

Poche recouverte de PVC sur les 2 faces, avec un embout spécial faïence.



Ref.		
302430		1

## BLISTER DE 5 DOSES D'ADJUVANT «JOINT +»

Le "JOINT +" augmente la résistance du béton aux cycles de gel/dégel et diminue la perméabilité.



	Ref.	
x 5	302458	1

## POCHE À JOINTS SÉRIE BÂTIMENT

Poche nylon. Livrée avec 2 buses.



Ref.		
302460		1

## GRATTE-JOINT

Manche plastique. Livré avec 2 lames au carbure de Tungstène



Ref.		
153570		1

## LAMES GRATTE-JOINT

Kit de 2 lames de rechange au carbure de Tungstène pour gratte-joint.



	Ref.	
x 2	153580	1

## ÉPONGES

### UTILISATION

- Plinthes et espaces exigus

### UNE GAMME COMPLÈTE

- En mousse synthétique, polyuréthane ou polyester grattante.



## ÉPONGE OVALE

En mousse synthétique.



L x l x H cm	Ref.	
15 x 11 x 5,8	155930	12

## ÉPONGE DE CARRELEUR

En mousse polyuréthane noir.

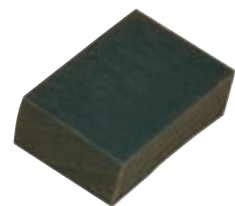

L x l x H cm	Ref.	
17 x 12 x 6,5	155900	12

## ÉPONGE HYDROGRATTANTE

1 face polyester absorbante et 1 face grattante.



L x l x H cm	Ref.	
18 x 12 x 5	155910	12

## ÉPONGE BLANCHE

En mousse synthétique.



L x l x H cm	Ref.	
17 x 12 x 6,5	155920	12

# CARRELEUR C'EST AUSSI...

## MAILLET DE CARRELEUR

>> PAGE 270

Ref.	
0346652201	3



## PLATOIR DEUX MAINS DENTÉ À COLLE / LAME 0,6 MM

>> PAGE 465

Ref.	
232401	3



## BAC ROND EN POLYÉTHYLÈNE NOIR 40 LITRES

>> PAGE 510

Ref.	
345040	1



## PLATOIR DENTÉ MONTURE FIBRE LAME 0,6 MM 6 X 6 X 6

>> PAGE 468

Ref.	
231601	3



## PLATOIR CHAPISTE LAME INOX POIGNÉE BANANE L45

>> PAGE 471

Ref.	
233241	1



## PLATOIR MONOBLOC À JOINTER

>> PAGE 472

Ref.	
152710	1



## ETUI DE 12 CRAIES HEXAGONALES

>> PAGE 243

Ref.	
813150	1



## PLATOIR MONOBLOC À NETTOYER POLYESTHER EP. 25

>> PAGE 473

Ref.	
152720	1



## NIVEAU TRAPÈZE

>> PAGE 239

Ref.	
872400	1



## PISTOLET POUR CARTOUCHES SÉRIE PROFESSIONNELLE

>> PAGE 506

Ref.	
153720	1



## HÉLICE CONIQUE SPEED 120

>> PAGE 509

Ref.	
881020	1



## CISEAU DE CARRELEUR

>> PAGE 292

Ref.	
7245250001	10









# 015

## PLATOIRS, COUTEAUX, TRUELLES

### PLATOIRS

**P.464**  
| PLATOIRS

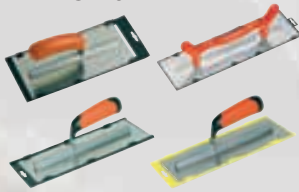

**P.468**  
| PLATOIRS MONTURE  
FIBRE DE VERRE



**P.469**  
| PLATOIRS POIGNÉE BOIS



**P.471**  
| PLATOIRS CHAPISTE



**P.472**  
| PLATOIRS À GRÉSER,  
À JOINTER ET À NETTOYER



### COUTEAUX

**P.475**  
| COUTEAUX  
À ENDUIRE POUR BRUT  
DE DÉCOFFRAGE

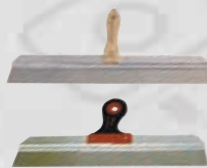

**P.477**  
| COUTEAUX À ENDUIRE



**P.478**  
| COUTEAUX  
AMÉRICAINS



**P.479**  
| COUTEAU  
À REBOUCHER



**P.480**  
| ERGOLAME®



### TRUELLES

**P.482**  
| TRUELLES MANCHE  
BOIS "EXCELLENCE",  
"AUTHENTIQUE"  
ET FORGÉES



**P.486**  
| TRUELLES MANCHE  
BIMATIÈRE, ACIER ET INOX



# PLATOIRS POIGNÉE PLASTIQUE

## PLATOIR UNE MAIN MONTURE ALU, POIGNÉE BANANE PLASTIQUE

### + LES PLUS

- Poignée ergonomique adaptée à des usages professionnels
- Les lames biseautées permettent un excellent serrage et lissage des enduits grâce à la qualité du biseau.

### PRÉSENTATION

- Tous les plateaux sont livrés avec un étui pour suspension sur broche et pour protection de la lame



Version lame courbe : facilite le chargement et la finition du joint

Fabrication à Ambierle



## PLATOIR MONTURE ALU LAME INOX

PLÂTRIER

PLAQUISTE

Épaisseur 0,6 mm.



Qualité de lame	L x l cm	Ref.	📦
Inox	28 x 12	231021	3

## PLATOIR MONTURE ALU LAME INOX TREMPÉ BISEAUTÉ

PLÂTRIER

PLAQUISTE

Épaisseur 0,6 mm.

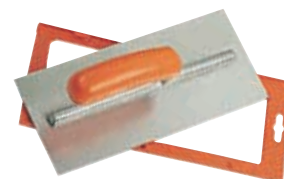

Qualité de lame	L x l cm	Ref.	📦
Inox trempé biseauté	28 x 12	231031	3

## PLATOIR MONTURE ALU LAME INOX

MAÇON

PLÂTRIER

Épaisseur 0,7 mm.



Qualité de lame	L x l cm	Ref.	📦
Inox	28 x 14	231221	4

## PLATOIR MONTURE ALU LAME ACIER TREMPÉ BISEAUTÉ SOUPLE

PEINTRE

Épaisseur 0,5 mm.



Qualité de lame	L x l cm	Ref.	📦
Acier trempé finement biseauté très souple	30,5 x 12	231214	6

## PLATOIR MONTURE ALU LAME ACIER TREMPÉ NICKELÉ

PLÂTRIER

Épaisseur 0,6 mm.



Qualité de lame	L x l cm	Ref.	📦
Acier trempé nickelé	28 x 12	231004	3

## PLATOIR MONTURE ALU LAME ACIER TREMPÉ NICKELÉ BISEAUTÉE

PLÂTRIER

Épaisseur 0,6 mm.



Qualité de lame	L x l cm	Ref.	📦
Acier trempé nickelé biseauté	28 x 12	231014	6

## PLATOIR MONTURE ALU LAME INOX COURBE SPECIAL PLAQUISTE

PLAQUISTE

COURBE

Courbe : facilite le chargement et la finition du joint. Épaisseur 0,6 mm.

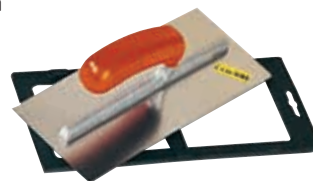

Qualité de lame	L x l cm	Ref.	📦
Inox courbe	28 x 12	231321	3

# PLATOIRS POIGNÉE PLASTIQUE



## PLATOIR DEUX MAINS

### + LES PLUS

- Poignée ergonomique qui permet le travail à une ou à deux mains
- Les lames biseautées permettent un excellent serrage et lissage des enduits grâce à la qualité du biseau.
- Les lames dentées des 2 côtés permettent une très bonne répartition de la colle



### CARACTÉRISTIQUES

- Monture alu
- Poignée plastique.



## PLATOIR DEUX MAINS LAME ACIER NICKELÉ

**PLÂTRIER**

Épaisseur 0,6 mm.



Qualité de lame	L x l cm	Ref.	📦
Acier nickelé	50 x 12	232004	3

## PLATOIR DEUX MAINS LAME ACIER BISEAUTÉ

**PLÂTRIER**

Épaisseur 0,6 mm.

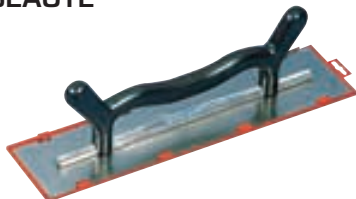

Qualité de lame	L x l cm	Ref.	📦
Acier biseauté	50 x 12	232014	3

## PLATOIR DEUX MAINS LAME INOX

**PLÂTRIER**

**PLAQUISTE**

Épaisseur 0,6 mm.

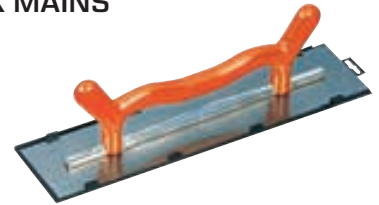

Qualité de lame	L x l cm	Ref.	📦
Inox	50 x 12	232021	3

## PLATOIR DEUX MAINS LAME INOX TREMPÉ BISEAUTÉ

**PLÂTRIER**

**PLAQUISTE**

Épaisseur 0,6 mm.

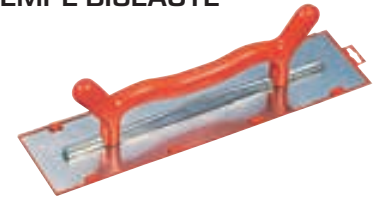

Qualité de lame	L x l cm	Ref.	📦
Inox trempé biseauté	50 x 12	232031	3

## PLATOIR DEUX MAINS LAME INOX TREMPÉ

**MAÇON**

**PLÂTRIER**

Épaisseur 0,7 mm.

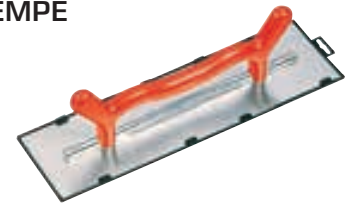

Qualité de lame	L x l cm	Ref.	📦
Inox trempé	50 x 14	232221	3

## PLATOIR DEUX MAINS LAME INOX TREMPÉ BISEAUTÉ

**PLÂTRIER**

**MAÇON**

Épaisseur 0,7 mm.



Qualité de lame	L x l cm	Ref.	📦
Inox trempé biseauté	50 x 14	232231	3

## PLATOIR DEUX MAINS DENTÉ À COLLE LAME INOX

**CARRELEUR**

**ITE**

Épaisseur 0,6 mm.



Denture mm	L x l cm	Ref.	📦
6 x 6 x 6 (carrée)	50 x 12	232401	3
8 x 8 x 8 (carrée)	50 x 12	232421	3
10 x 10 x 10 (carrée)	50 x 12	232431	3



16



62



96



120



126



156



188



224



248



254



300



316



340



390



462



488



465

## PLATOIR MONTURE ALU POIGNÉE BI-MATIÈRE TOUCHER "SOFT"

### + LES PLUS

- Modèle déposé. Design élaboré
- Lame en épaisseur 0,6 mm, compromis idéal entre rigidité et souplesse
- Lame du professionnel
- Lame inox trempé biseauté : la qualité du biseau permet un excellent serrage et lissage des enduits
- Haute résistance
- Légèreté de la poignée monture en aluminium moulé
- Confort de travail : poignée bi-matière toucher "Soft"



### PRÉSENTATION

- Tous les plateaux sont livrés avec un étui pour suspension sur broche et protection de la lame

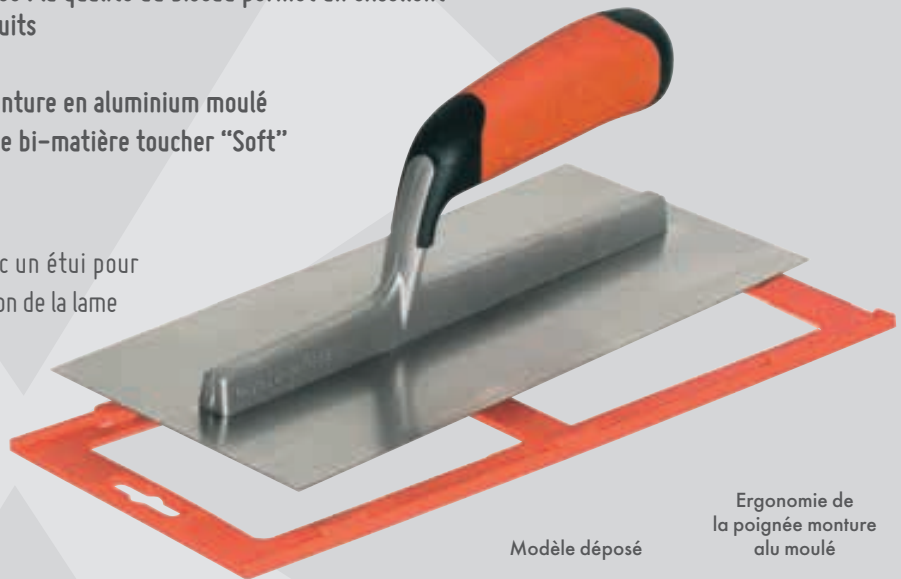

Modèle déposé

Ergonomie de la poignée monture alu moulé

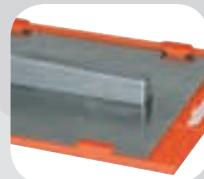

### PLATOIR MONTURE ALU LAME INOX

#### PLÂTRIER

Épaisseur 0,6 mm



Qualité de lame	L x l cm	Ref.	📦
Inox	28 x 12	234521	3

### PLATOIR MONTURE ALU LAME INOX TREMPÉ BISEAUTÉ

#### PLAQUISTE

Épaisseur 0,6 mm



Qualité de lame	L x l cm	Ref.	📦
Inox trempé biseauté	28 x 12	234531	3

### PLATOIR MONTURE ALU LAME INOX TREMPÉ BISEAUTÉ

#### PLAQUISTE

Épaisseur 0,6 mm



Qualité de lame	L x l cm	Ref.	📦
Inox trempé biseauté	35 x 10	234541	3

### PLATOIR MONTURE ALU LAME INOX COURBE

La lame courbe facilite le chargement et la finition du joint. Épaisseur 0,6 mm

#### PLAQUISTE

#### COURBE



Qualité de lame	L x l cm	Ref.	📦
Inox courbe	28 x 12	234551	3

# PLATOIRS MONTURE ALU POIGNÉE BI-MATIÈRE



## PLATOIR DEUX MAINS POIGNÉE FERMÉE

Lame inox,  
monture profilé alu.  
Épaisseur 0,6 mm.

**PLÂTRIER**

**PLAQUISTE**



Qualité de lame	L x l cm	Ref.	☐
Inox trempé biseauté	38 x 12	234221	2
Inox trempé biseauté	50 x 12	234031	3

## PLATOIR COURBE DEUX MAINS SPÉCIAL PLAQUISTE

La lame courbe inox facilite le  
chargement et la finition du joint.  
Monture profilé Alu.  
Épaisseur 0,6 mm.

**PLAQUISTE**

**COURBE**



Qualité de lame	L x l cm	Ref.	☐
Inox courbe	38 x 12	231331	2

## PLATOIRS DENTÉS MONTURE ALU POIGNÉE BI-MATIÈRE TOUCHER "SOFT"

### + LES PLUS

- Haute résistance
- Confort de travail : poignée ergonomique
- Lame inox dentée deux côtés



### PRÉSENTATION

- Tous les platoirs dentés à colle sont livrés avec un étui pour suspension sur broche et pour protection de la lame dentée.

Fabrication à Ambierle



## PLATOIR DENTÉ MONTURE ALU LAME INOX DENTURE CARRÉE

Lame inox dentée deux côtés.  
Épaisseur 0,6 mm.

**CARRELEUR** **ITE**



Denture mm	L x l cm	Ref.	☐
carrée 6 x 6 x 6	28 x 12	234641	3
carrée 8 x 8 x 8	28 x 12	234651	3
carrée 10 x 10 x 10	28 x 12	234661	3
carrée 12 x 12 x 12	28 x 12	234691	3

## PLATOIR DENTÉ MONTURE ALU LAME INOX ISOCELE

Lame inox dentée deux côtés.  
Épaisseur 0,6 mm.

**CARRELEUR**



Denture mm	L x l cm	Ref.	☐
isocèle 6 x 6	28 x 12	234671	3

## PLATOIR DENTÉ MONTURE ALU LAME INOX 1/2 RONDE

Lame inox dentée deux côtés. Épaisseur 0,6 mm.

**CARRELEUR**



Denture mm	L x l cm	Ref.	☐
1/2 ronde Ø 20	28 x 12	234681	3



16



62



96



120



126



156



188



224



248



254



300



316



340



390



462



488



467

# PLATOIRS MONTURE FIBRE DE VERRE

## PLATOIR MONTURE FIBRE DE VERRE POIGNÉE BI-MATIÈRE TOUCHER «SOFT»

### QUALITÉ

- Monture polyamide chargé fibre de verre.
- Très hautes propriétés mécaniques.  
Excellente résistance aux chocs.  
Souplesse et légèreté.
- Poignée bi-matière toucher "Soft"
- Les lames inox biseautées permettent un excellent serrage et lissage des enduits grâce à la qualité du biseau.



### PLATOIR MONTURE FIBRE DE VERRE LAME INOX TREMPÉ

Épaisseur 0,6 mm.

**PLÂTRIER**  
**PLAQUISTE**



Qualité de lame	L x l cm	Ref.	☐
Inox trempé	35 x 10	231531	3

### PLATOIR MONTURE FIBRE DE VERRE LAME INOX

Épaisseur 0,6 mm.

**PLÂTRIER**  
**PLAQUISTE**



Qualité de lame	L x l cm	Ref.	☐
Inox	28 x 12	231521	3

### PLATOIR MONTURE FIBRE DE VERRE LAME INOX TREMPÉ BISEAUTÉ

Épaisseur 0,6 mm.

**PLÂTRIER**  
**PLAQUISTE**



Qualité de lame	L x l cm	Ref.	☐
Inox trempé biseauté	28 x 10	231551	3
Inox trempé biseauté	28 x 12	231561	3

### PLATOIR MONTURE FIBRE DE VERRE LAME INOX TREMPÉ BISEAUTÉ

Épaisseur 0,6 mm.

**PLÂTRIER**  
**PLAQUISTE**



Qualité de lame	L x l cm	Ref.	☐
Inox trempé biseauté	35 x 10	231541	3

### PLATOIR MONTURE FIBRE DE VERRE LAME INOX DENTURE CARRÉE

Lame inox dentée 2 côtés.  
Épaisseur 0,6 mm.

**CARRELEUR**  
**ITE**

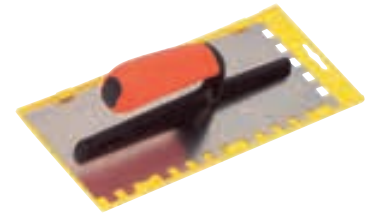

Denture mm	L x l cm	Ref.	☐
carrée 6 x 6 x 6	28 x 12	231601	3
carrée 8 x 8 x 8	28 x 12	231641	3
carrée 10 x 10 x 10	28 x 12	231611	3
carrée 12 x 12 x 12	28 x 12	231651	3

### PLATOIR MONTURE FIBRE DE VERRE LAME INOX DENTURE ISOCÈLE

Lame inox dentée 2 côtés.  
Épaisseur 0,6 mm.

**CARRELEUR**

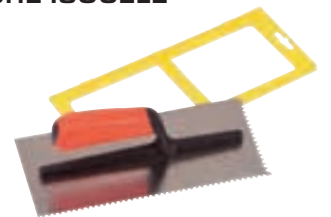

Denture mm	L x l cm	Ref.	☐
isocèle 6 x 6	28 x 12	231631	3

### PLATOIR MONTURE FIBRE DE VERRE LAME INOX DENTURE 1/2 RONDE

Lame inox denté 2 côtés.  
Épaisseur 0,6 mm.

**CARRELEUR**



Denture mm	L x l cm	Ref.	☐
1/2 ronde Ø 20	28 x 12	231621	3



## PLATOIR "ALSACE" MONTURE FIBRE DE VERRE LAME INOX

Poignée bois.  
Épaisseur 0,6 mm.

**PLÂTRIER**



Qualité de lame	L x l cm	Ref.	📦
Inox	28 x 12	231811	3

## PLATOIR MONTURE FIBRE DE VERRE LAME INOX

Poignée bois.  
Épaisseur 0,6 mm.

**PLÂTRIER**



Qualité de lame	L x l cm	Ref.	📦
Inox	28 x 12	231421	6

## PLATOIR ESPAGNOL LAME INOX

Poignée bois.  
Épaisseur 0,7 mm.

**MAÇON**

**PLÂTRIER**



Qualité de lame	L x l cm	Ref.	📦
Inox	30 x 14	231831	5

## PLATOIR ESPAGNOL LAME INOX BISEAUTÉE

Les lames biseautées permettent un excellent serrage et lissage des enduits grâce à la qualité du biseau.

Poignée bois.  
Épaisseur 0,6 mm.

**PLÂTRIER**

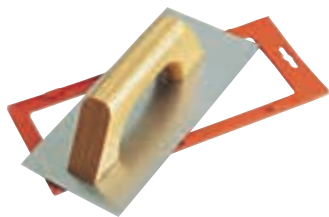

Qualité de lame	L x l cm	Ref.	📦
Inox biseauté	28 x 12	231841	5

## PLATOIR ESPAGNOL À COLLE LAME INOX DENTURÉ CARRÉE 6x6

Lame inox dentée 2 côtés.  
Poignée bois.  
Épaisseur 0,6 mm.

**CARRELEUR**

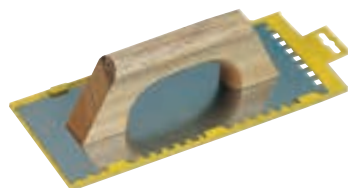

Denture mm	L x l cm	Ref.	📦
Carrée 6 x 6 x 6	28 x 12	231861	5

## PLATOIR ESPAGNOL À COLLE LAME INOX DENTURÉ CARRÉE 8x8

Lame inox dentée 2 côtés.  
Épaisseur 0,6 mm.

**CARRELEUR**

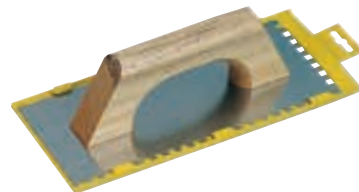

Denture mm	L x l cm	Ref.	📦
Carrée 8 x 8 x 8	28 x 12	231891	5

## PLATOIR ESPAGNOL À COLLE LAME INOX DENTURÉ CARRÉE 10x10

Lame inox dentée 2 côtés.  
Épaisseur 0,6 mm.

**CARRELEUR**

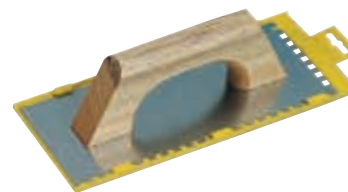

Denture mm	L x l cm	Ref.	📦
Carrée 10 x 10 x 10	28 x 12	231871	5

## PLATOIR ESPAGNOL À COLLE LAME INOX DENTURÉ ISOCELE

Lame inox dentée 2 côtés.  
Épaisseur 0,6 mm.

**CARRELEUR**

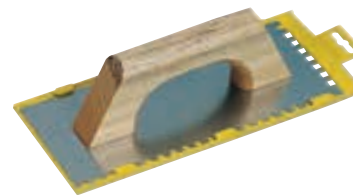

Denture mm	L x l cm	Ref.	📦
Isocèle 6 x 6	28 x 12	231881	5

## PLATOIR "SUISSE" DEUX MAINS LAME INOX BISEAUTÉE

Épaisseur 0,7 mm.

**MAÇON**

**PLÂTRIER**



Qualité de lame	Épaisseur de lame mm	L x l cm	Ref.	📦
Inox biseauté	0,7	50 x 14	233111	3

## PLATOIR "SUISSE" DEUX MAINS LAME ACIER TREMPÉ

Épaisseur 0,7 mm.

**MAÇON**

**PLÂTRIER**



Qualité de lame	L x l cm	Ref.	📦
Acier trempé	50 x 14	233104	3



16



62



96



120



126



156



188



224



248



254



300



316



340



390



462



488

# PLATOIRS POIGNÉE PLASTIQUE

## PLATOIR MONTURE ALU LAME INOX TREMPÉ POIGNÉE PLASTIQUE

### + LES PLUS

- Résistant aux solvants
- Légèreté grâce à la monture du profilé aluminium
- Ergonomie de la poignée plastique



#### UTILISATION

- Conseillé pour les finitions du type "faux marbre" et les enduits liquides.

## PLATOIR MONTURE ALU LAME INOX TREMPÉ BISEAUTÉ SOUPLE

Épaisseur 0,5 mm.

PLÂTRIER  
PEINTRE



Qualité de lame	L x l cm	Ref.	📦
Inox trempé biseauté souple	20 x 8	231701	6

## PLATOIR LAME INOX SOUPLE POIGNÉE PLASTIQUE

Épaisseur 0,5 mm.

PLÂTRIER  
PEINTRE



Qualité de lame	L x l cm	Ref.	📦
Inox trempé souple	20 x 8	231711	6

## PLATOIR MONTURE ALU LAME INOX TREMPÉ SOUPLE

Épaisseur 0,5 mm.

PLÂTRIER  
PEINTRE

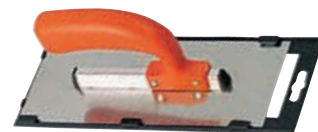

Qualité de lame	L x l cm	Ref.	📦
Inox trempé souple	24 x 10	231741	6

## PLATOIR MONTURE ALU LAME INOX ARRONDIE TREMPÉ BISEAUTÉE

Épaisseur 0,5 mm.

PLÂTRIER  
PEINTRE



Qualité de lame	L x l cm	Ref.	📦
Inox trempé biseauté, angles arrondis, souple	20 x 8	231761	6

## PLATOIR MONTURE ALU LAME INOX ARRONDIE TREMPÉ

Épaisseur 0,5 mm.

PLÂTRIER  
PEINTRE



Qualité de lame	L x l cm	Ref.	📦
Inox trempé, angles arrondis, souple	24 x 11	231771	6

## PLATOIR ESPAGNOL MONTURE ALU LAME INOX

Épaisseur 0,6 mm.

PLÂTRIER

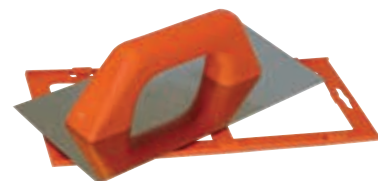

Qualité de lame	L x l cm	Ref.	📦
Inox biseauté	28 x 12	231911	5
Inox	28 x 12	231921	5

## PLATOIR ESPAGNOL MONTURE ALU LAME INOX

Épaisseur 0,7 mm.

PLÂTRIER  
MAÇON



Qualité de lame	L x l cm	Ref.	📦
Inox	30 x 14	231901	5





## PLATOIR CHAPISTE MONTURE PROFILÉ ALU LAME INOX TREMPÉ POIGNÉE FERMÉE



### + LES PLUS

- Angle du talon arrondi.
- Légèreté grâce au profilé alu et résistance grâce à la poignée fermée fixée par 4 rivets.
- Bout ogive. Monture profilé alu.
- Lame en inox trempé épaisseur : 1 mm



Soudure des rivets sur la lame



### UTILISATION

- Platoir une main pour lisser les chapes.
- Egalement appelé platoir flamand.

### PRÉSENTATION

- Etui de protection de la lame et de suspension sur broche.



### PLATOIR «FLAMAND» CHAPISTE LAME INOX TREMPÉ L45

Lame épaisseur : 1 mm.  
Bout ogive.

**MAÇON**  
**CARRELEUR**



Qualité de lame	L x l cm	Ref.	📦
Inox trempé	45 x 12 / 9	233221	1

### PLATOIR «FLAMAND» CHAPISTE LAME INOX TREMPÉ L55

Lame épaisseur : 1 mm.  
Bout ogive.

**MAÇON**  
**CARRELEUR**



Qualité de lame	L x l cm	Ref.	📦
Inox trempé	55 x 12 / 9	233231	1

### PLATOIR CHAPISTE MONTURE ALU LAME INOX TREMPÉ POIGNÉE BANANE

Lame épaisseur : 1 mm.  
Monture alu. Bout ogive.

**MAÇON**  
**CARRELEUR**



Qualité de lame	L x l cm	Ref.	📦
Inox trempé	45 x 12 / 9	233241	1
Inox trempé	55 x 12 / 9	233251	1

### PLATOIR «FLAMAND» CHAPISTE LAME ACIER POIGNÉE PLASTIQUE FERMÉE

Monture alu. Bout ogive.

**MAÇON**  
**CARRELEUR**



L x l cm	📦 g	Ref.	📦
45x12	585	233314	1
55x12	600	233324	1
60x12	1050	233334	1
70x12	1100	233344	1

### PLATOIR «FLAMAND» CHAPISTE LAME ACIER POIGNÉE PLASTIQUE FERMÉE L45

Monture alu. Bout rond.

**MAÇON**  
**CARRELEUR**



L x l cm	📦 g	Ref.	📦
45 x 12	585	233404	1

### PLATOIR CHAPISTE LAME ACIER TREMPÉ NICHELÉ POIGNÉE BANANE

Lame épaisseur : 1 mm.  
Monture alu. Bout ogive.

**MAÇON**  
**CARRELEUR**



Qualité de lame	L x l cm	Ref.	📦
Acier trempé nickelé	45 x 12 / 9	233204	1
Acier trempé nickelé	55 x 12 / 9	233214	1



16



62



96



120



126



156



188



224



248



254



300



316



340



390



462



488



471



# PLATOIRS À JOINTER - À GRÉSER

## PLATOIR MONOBLOC À JOINTER



### + LE PLUS

- Poignée ergonomique qui assure un meilleur confort de travail



### UTILISATION

- Pour le jointoiment.

### CARACTÉRISTIQUES

- Plateau et poignée monobloc en polystyrène choc.
- Semelle caoutchouc noir 8 mm.



## PLATOIR MONOBLOC À JOINTER

PS choc.  
Semelle caoutchouc noir 8 mm.

**CARRELEUR**



L x l cm	Ref.	📦
29 x 14	152710	1

## PLATOIR À JOINTER POIGNÉE PLASTIQUE SOUDÉE

Semelle caoutchouc noir 8 mm.

**CARRELEUR**



L x l cm	Ref.	📦
29 x 14	152510	1

## PLATOIR À JOINTER PLATEAU INOX

Poignée bois.  
Semelle caoutchouc noir 8 mm.

**CARRELEUR**



L x l cm	Ref.	📦
29 x 14	152500	4

## PLATOIR À JOINTER MONOBLOC EPOXY

Pour jointoiment époxy et synthétique. Plateau et poignée monobloc en polystyrène choc. Semelle matière caoutchoutée orange épaisseur : 9 mm. Bords biseautés.



L x l cm	Ref.	📦
25 x 11	152560	1

## PLATOIR À GRÉSER POIGNÉE FERMÉE

Polystyrène choc.

**MAÇON**  
**PEINTRE**



L x l cm	Ref.	📦
28 x 13	101100	6

## PLATOIR À GRÉSER POIGNÉE BANANE OUVERTE

Polystyrène choc.

**MAÇON**  
**PEINTRE**



L x l cm	Ref.	📦
28 x 13	101110	5

## PLATOIR PVC POIGNÉE BI-MATIÈRE TOUCHER "SOFT"

Plateau P.V.C. épaisseur : 3 mm.  
Monture en polyamide fibre de verre.

**MAÇON**  
**PEINTRE**



L x l cm	Ref.	📦
28 x 12	101120	6

# PLATOIRS À NETTOYER ✂

## PLATOIR À NETTOYER AVEC DOUILLE SOUDÉE

Monture plastique avec douille orientable en acier zingué pour réception du manche. Semelle mousse polyester blanche 40 mm.

**CARRELEUR** **TMS**

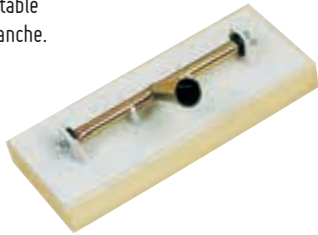

Qualité mousse	Épaisseur mousse mm	L x l cm	Ref.	📦
Polyester blanc	40	34 x 13	152540	1

## PLATEAU MOUSSE INTERCHANGEABLE

Livré sans la douille acier. Pour réf 152540.

**CARRELEUR**



Qualité mousse	Épaisseur mousse mm	L x l cm	Ref.	📦
Polyester blanc	40	34 x 13	152550	1

## PLATOIR À NETTOYER POIGNÉE PLASTIQUE SOUDÉE

Semelle mousse polyester blanche. Poignée plastique soudée sur le plateau plastique.

**CARRELEUR**



Qualité mousse	Épaisseur mousse mm	L x l cm	Ref.	📦
Polyester blanc	25	29 x 14	152520	1
Polyester blanc	40	29 x 14	152530	1

## PLATOIR MONOBLOC À NETTOYER TAMPONS ABRASIFS

Préconisé pour la finition des joints époxy. Plateau et poignée monobloc en polystyrène choc. Muni de bandes velcro pour fixation des tampons abrasifs en fibre nylon (25 x 11,5 cm). Livré avec un tampon blanc plutôt doux et un tampon bleu plus agressif.

**CARRELEUR**

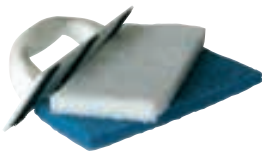

L x l cm	Ref.	📦
25 x 11	152570	1

## TAMPONS ABRASIFS DE RECHANGE



	Ref.	📦
1 bleu + 1 blanc	152610	1
3 blancs	152590	1
3 bleus	152600	1

## PLATOIR MONOBLOC À NETTOYER

### + LE PLUS

- Poignée ergonomique qui assure un meilleur confort de travail



### UTILISATION

- Pour le nettoyage des joints ciment

### CARACTÉRISTIQUES

- Plateau et poignée monobloc en polystyrène choc
- Semelle mousse polyester (PE) ou polyuréthane (PU).



## PLATOIR MONOBLOC À NETTOYER SEMELLE POLYESTER EP. 25

Plateau et poignée monobloc en polystyrène choc. Semelle mousse.

**CARRELEUR**



Qualité mousse	Épaisseur mousse mm	L x l cm	Ref.	📦
Polyester blanc	25	29 x 14	152720	1

## PLATOIR MONOBLOC À NETTOYER SEMELLE POLYESTER EP. 40

Plateau et poignée monobloc en polystyrène choc. Semelle mousse.

**CARRELEUR**

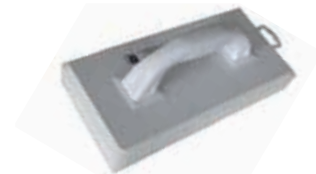

Qualité mousse	Épaisseur mousse mm	L x l cm	Ref.	📦
Polyester blanc	40	29 x 14	152730	1

## PLATOIR MONOBLOC À NETTOYER SEMELLE POLYURÉTHANE EP. 40

Plateau et poignée monobloc en polystyrène choc. Semelle mousse.

**CARRELEUR**



Qualité mousse	Épaisseur semelle mm	L x l cm	Ref.	📦
Polyuréthane havane	40	29 x 14	152740	1



16



62



96



120



126



156



188



224



248



254



300



316



340



390



462



488



473



# PLATOIRS À NETTOYER

## GRAND PLATOIR MONOBLOC SEMELLE POLYESTER EP. 40

Plateau et poignée monobloc en polystyrène choc. Semelle mousse.



Qualité mousse	Epaisseur mousse mm	L x l cm	Ref.	
Polyester blanc	40	34 x 17	152820	1

## GRAND PLATOIR MONOBLOC SEMELLE POLYURÉTHANE EP. 40

Plateau et poignée monobloc en polystyrène choc. Semelle mousse.



Qualité mousse	Epaisseur mousse mm	L x l cm	Ref.	
Polyuréthane havane	40	34 x 17	152830	1

## PLATOIR MONOBLOC À NETTOYER SEMELLE MOUSSE JAUNE EP. 30

Plateau et poignée monobloc en polystyrène choc. Epaisseur mousse : 30 mm.

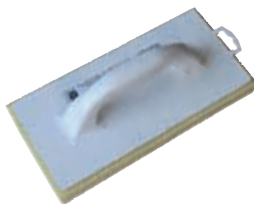

Qualité mousse	Epaisseur mousse mm	L x l cm	Ref.	
Fine jaune	30	29 x 14	152760	1

## PLATOIR MONOBLOC MOUSSE QUADRILLÉE

### + LES PLUS

- Semelle mousse alvéolée, quadrillée 30 x 30 mm pour un nettoyage plus efficace des carreaux. Mousse polyuréthane (PU) havane 40 mm.
- Poignée ergonomique qui assure un meilleur confort de travail.
- Plateau et poignée monobloc en polystyrène choc.

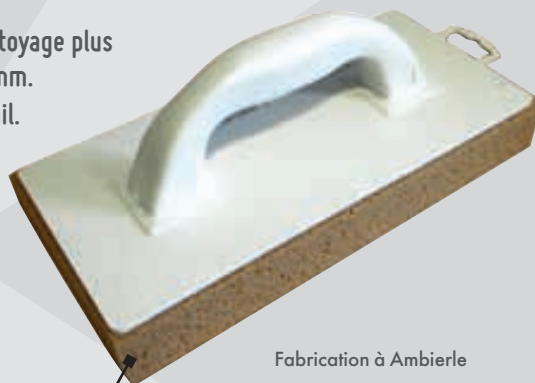

Fabrication à Ambierle

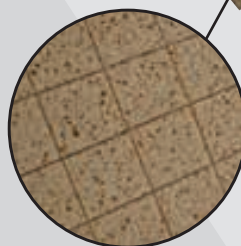

## PLATOIR MONOBLOC POLYURÉTHANE QUADRILLÉ EP. 40

Plateau et poignée monobloc en polystyrène choc. Semelle mousse PU.

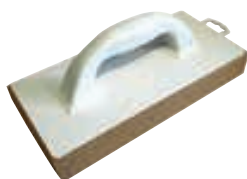

Qualité mousse	Epaisseur mousse mm	L x l cm	Ref.	
Polyuréthane havane quadrillée	40	29 x 14	152750	1

## GRAND PLATOIR MONOBLOC MOUSSE QUADRILLÉE EP. 40

Plateau et poignée monobloc en polystyrène choc. Semelle mousse alvéolée PU havane 40 mm. Quadrillée 30 x 30

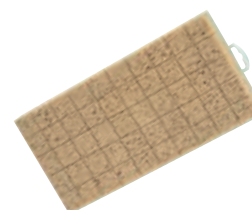

Qualité mousse	Epaisseur mousse mm	L x l cm	Ref.	
Polyuréthane havane quadrillée	40	34 x 17	152840	1

# COUTEAUX À ENDUIRE FAÇADIER



## COUTEAU À ENDUIRE POUR BRUT DE DÉCOFFRAGE

### CARACTÉRISTIQUES

- Lame inox trempé.
- Épaisseur : 0,6 mm.



### GAMME

- Poignée bois ou bi-matière toucher «Soft»
- Lame classique ou arrondie aux angles, ce qui permet d'éviter les traces sur l'enduit.



### COUTEAU À ENDUIRE POIGNÉE BOIS

Renfort alu, lame inox trempé.

FAÇADIER



L cm	Hauteur de lame mm	Ref.	📦
50	48	224500	1
60	48	224600	1

### COUTEAU À ENDUIRE POIGNÉE BOIS, ANGLES ARRONDIS

Renfort alu, lame inox trempé.

FAÇADIER



L cm	Hauteur de lame mm	Ref.	📦
50	48	224620	1
60	48	224630	1

### COUTEAU À ENDUIRE POIGNÉE ET MONTURE CONTREPLAQUE BOIS

Lame inox trempé.

FAÇADIER



L cm	Hauteur de lame mm	Ref.	📦
35	48	224640	1
50	48	224650	1
60	48	224660	1

### COUTEAU À ENDUIRE POIGNÉE BI-MATIÈRE TOUCHER "SOFT"

Renfort alu, lame inox trempé.

FAÇADIER



L cm	Hauteur de lame mm	Ref.	📦
35	48	226350	1
50	48	226500	1
60	48	226600	1

### COUTEAU À ENDUIRE POIGNÉE BI-MATIÈRE TOUCHER "SOFT" ANGLES ARRONDIS

Renfort alu, lame inox trempé.

FAÇADIER



L cm	Hauteur de lame mm	Ref.	📦
35	48	226730	1
50	48	226750	1
60	48	226760	1
80	48	226780	1

### COUTEAU À ENDUIRE DOUBLE POIGNÉE BOIS

Lame inox trempé.

FAÇADIER



L cm	Hauteur de lame mm	Épaisseur mm	Ref.	📦
50	48	0,6	224670	1



16



62



96



120



126



156



188



224



248



254



300



316



340



390



462



488



475

# COUTEAUX À ENDUIRE FAÇADIER

## SPATULE EXTRA-SOUPLE POUR LISSER LES ENDUITS



### + LES PLUS

- Poignée ergonomique déportée
- Angles arrondis pour ne pas laisser de trace à la finition
- Lame extra-souple 0,2 mm

### UTILISATION

- Permet de lisser les enduits ou d'écraser le grain du crépi.

### CARACTÉRISTIQUES

- Lame en acier trempé épaisseur : 0,2 mm.



## SPATULE EXTRA-SOUPLE POUR LISSER LES ENDUITS

Angles arrondis.

FAÇADIER



Largeur cm	Hauteur de lame mm	Épaisseur de lame mm	Ref.	☐
17,5	78	0,2	224840	1

## SPATULE EXTRA-SOUPLE LARGE POUR LISSER LES ENDUITS

Poignée plastique ergonomique. Lame extra-souple. Angles arrondis.

FAÇADIER



Largeur cm	Hauteur de lame mm	Épaisseur de lame mm	Ref.	☐
25	78	0,2	224830	1

## SPATULE EXTRA-SOUPLE POUR LISSER LES ENDUITS MANCHE BOIS

Manche bois ergonomique. lame en acier trempé extra-souple.

FAÇADIER



Largeur cm	Hauteur de lame mm	Épaisseur de lame mm	Ref.	☐
25	78	0,2	224850	1

## COUTEAU À ENDUIRE ET À JOINTER LES BANDES, INOX

Poignée bois. Renfort alu, lame inox trempé, épaisseur : 0,5 mm.

FAÇADIER

PLAQUISTE



Largeur cm	Hauteur de lame mm	Épaisseur de lame mm	Ref.	☐
25	98	0,5	224250	1
30	98	0,5	224300	1
35	98	0,5	224350	1

## COUTEAU À ENDUIRE INOX POUR BRUT DE DECOFFRAGE

Avec douille métallique. Renfort alu, lame inox trempé. Épaisseur : 0,5 mm.

FAÇADIER



Largeur cm	Hauteur de lame mm	Épaisseur de lame mm	Ref.	☐
60	98	0,5	224610	1



## COUTEAU À ENDUIRE INOX TREMPÉ, MANCHE BI-MATIÈRE TOUCHER «SOFT»

Série **PREMIUM**

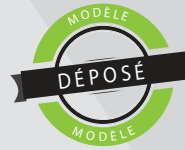

### + LES PLUS

- lame inox trempé haute qualité
- Excellente durabilité
- Excellente prise en main approuvée par les professionnels
- Poignée ambidextre pour une utilisation aussi bien pour les droitiers que les gauchers
- Design issu de la collaboration entre notre bureau d'études et notre designer



### COUTEAU À ENDUIRE LAME INOX TREMPÉ, SÉRIE PREMIUM

Épaisseur : 0,5 mm. Poignée bi-matière toucher «Soft».

Largeur cm	Épaisseur mm	Ref.	☐
10	0,5	223300	6
12	0,5	223320	6
14	0,5	223340	6
16	0,5	223360	6
18	0,5	223380	6
20	0,5	223400	6
22	0,5	223420	6
24	0,5	223440	6
30	0,5	223490	6



16



62



96



120



126



156



188



224



248



254



300



316



340



390



462



488



# COUTEAUX À ENDUIRE

## COUTEAU À ENDUIRE INOX TREMPÉ, MANCHE BI-MATIÈRE TOUCHER «SOFT»

### Série CLASSIC

#### + LES PLUS

- Facile à nettoyer
- Léger et confortable

#### QUALITÉ DE LAME

- Lame inox trempé haute qualité



## COUTEAU AMÉRICAIN BI-MATIÈRE

#### QUALITÉ

- Lame inox, flexible, polie brillant.
- Poignée bi-matière toucher "Soft".



## COUTEAU À ENDUIRE LAME INOX TREMPÉ SÉRIE CLASSIC

Lame associant dureté et souplesse. Manche bi-matière toucher «Soft». Épaisseur : 0,5 mm.



Largeur cm	Épaisseur mm	Ref.	📦
10	0,5	223100	8
12	0,5	223120	8
14	0,5	223140	8
16	0,5	223160	8
18	0,5	223180	8
20	0,5	223200	8
22	0,5	223220	8
24	0,5	223240	8
30	0,5	223290	8

## COUTEAU À ENDUIRE LAME ACIER TREMPÉ

Manche polypropylène. Épaisseur : 0,5 mm.



Largeur cm	Épaisseur mm	Ref.	📦
10	0,5	222100	6
12	0,5	222120	6
14	0,5	222140	6
16	0,5	222160	6
18	0,5	222180	6
20	0,5	222200	6
22	0,5	222220	6
24	0,5	222240	6

## COUTEAU AMÉRICAIN MANCHE BI-MATIÈRE TOUCHER «SOFT»

Lame inox, flexible, polie brillant.

Largeur mm	Largeur pouces	Ref.	📦
31	1 1/4	221700	6
38	1 1/2	221710	6
51	2	221720	6
76	3	221730	6
102	4	221740	6
127	5	221750	6
152	6	221760	6



## COUTEAU AMÉRICAIN AVEC EMBOUT MANCHE BI-MATIÈRE TOUCHER «SOFT»

Embout de vissage PH2.

Lame inox, flexible, polie brillant.

Largeur mm	Largeur pouces	Ref.	📦
102	4	221770	6
127	5	221780	6
152	6	221790	6



## COUTEAU AMÉRICAIN

Spatule de peintre de type américain. Soie traversante. Lame inox, flexible, polie brillant. Manche plastique résistant aux solvants et facile à nettoyer.

Largeur mm	Largeur pouces	Ref.	📦
31	1 1/4	221600	6
38	1 1/2	221610	6
51	2	221620	6
76	3	221630	6
102	4	221640	6
127	5	221650	6
152	6	221660	6







## COUTEAU À REBOUCHER LAME ACIER MANCHE BOIS

Dit aussi couteau de peintre.  
Lame acier.



Largeur cm	Ref.	☐
4	220040	5
5	220050	5
6	220060	5
7	220070	5
8	220080	5
10	220100	5

## COUTEAU À REBOUCHER LAME INOX MANCHE BOIS

Dit couteaux de peintre.  
Lame en acier inoxydable.



Largeur cm	Ref.	☐
4	220140	5
5	220150	5
6	220160	5
7	220170	5
8	220180	5
10	220200	5

## COUTEAU À REBOUCHER MASSIF LAME ACIER MANCHE BOIS

Dit couteau de peinture  
type anglais.  
Lame acier à embase  
massive forgée.  
Manche palissandre.  
Virole laitonée.



Largeur cm	Ref.	☐
4	220240	5
5	220250	5
6	220260	5
7	220270	5

## COUTEAU MULTI USAGES MANCHE PLASTIQUE

Pour décaper, racler et  
nettoyer les rouleaux.  
Lame en acier trempé.  
Soie traversante.



Ref.	☐
224910	6

## COUTEAU À MASTIQUER MANCHE BOIS

Lame acier trempé, vernie.  
Type feuille de laurier.



Ref.	☐
224870	5

## COUTEAU À MASTIQUER COURBE MANCHE BOIS

Lame acier trempé, vernie.  
Type poignard courbe.



Ref.	☐
224880	5

## RIFLARD MANCHE BOIS

Avec trou d'accrochage.  
Lame acier trempé.



Largeur cm	Ref.	☐
7	225870	5

## RIFLARD MANCHE PLASTIQUE

Manche ergonomique en polypropylène avec  
trou d'accrochage. Lame en inox trempé.



Largeur cm	Ref.	☐
7	225880	1



16



62



96



120



126



156



188



224



248



254



300



316



340



390



462



488



479

## ERGOLAME®



## ERGOLAME®

### + LES PLUS

- Développé en collaboration avec nos artisans partenaires, ce produit extrêmement ergonomique permet une excellente prise en main, notamment la largeur ainsi que la forme de la poignée sont complètement adaptées à la forme de la main pour un lissage facile et rapide.
- La lame est entièrement dégagée pour un lissage parfait « sans trace » et pliée pour conjuguer rectitude et souplesse.
- Un outil performant, ergonomique, pour un maximum d'utilisations et un lissage de qualité.
- Un outil pratique : nettoyage facile, lame interchangeable grâce à la clé de serrage logée dans l'outil.

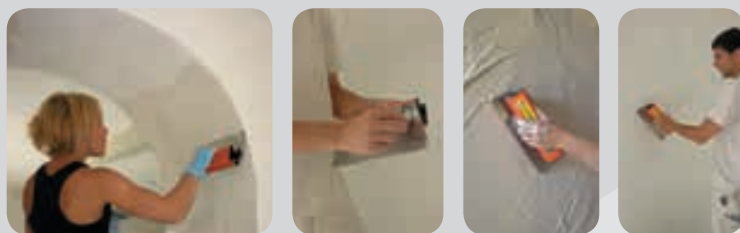

Vue de dessous

### UNE GAMME COMPLÈTE

Une gamme complète est disponible pour répondre à un maximum d'utilisations, pour tous types de travaux, de la petite surface à la grande surface :

• ERGOLAME® lissage 6/10<sup>ème</sup> : pour le lissage des enduits, serrage des bandes, réalisation des joints de plaque de plâtre, projeté façade, plâtre...

Lame inox rigide 100 mm. Epaisseur : 0,6 mm.

• ERGOLAME® finition 4/10<sup>ème</sup> : pour la réalisation des enduits de finition, de décoration (fibrite, enduit airless, enduit stuc...). Lame inox extra souple 120 mm. Epaisseur : 0,4 mm.

• ERGOLAME® spécial carreleur : pour l'encollage des carreaux et faïence.

• ERGOLAME® spécial façadier : pour la réalisation des façades et le collage des polystyrènes en isolation extérieure.



227500  
150 mm

227510  
300 mm

227520  
500 mm

227530  
600 mm

227540  
800 mm

227600  
150 mm

227610  
300 mm

### ERGOLAME® LISSAGE

Pour le lissage des enduits, serrage des bandes, réalisation des joints de plaque de plâtre, projeté façade, plâtre...



Longueur mm	Largeur mm	Epaisseur mm	Ref.	☐
150	100	0,6	227500	2
300	100	0,6	227510	2
500	100	0,6	227520	2
600	100	0,6	227530	2
800	100	0,6	227540	2

### ERGOLAME® FINITION

Pour la réalisation des enduits de finition, de décoration (fibrite, enduit airless, enduit stuc...).



Longueur mm	Largeur mm	Epaisseur mm	Ref.	☐
150	120	0,4	227600	2
300	120	0,4	227610	2
500	120	0,4	227620	2
600	120	0,4	227630	2
800	120	0,4	227640	2



## ERGOLAME® DENTÉ



### UTILISATION

- Pour l'encollage des carreaux, faïence, isolants, sous-enduits.
- Un geste facilité grâce à sa poignée ergonomique et sa lame dégagée.

### CARACTÉRISTIQUES

- lame interchangeable.
- lame inox dentée 120 mm, épaisseur 0,6 mm.

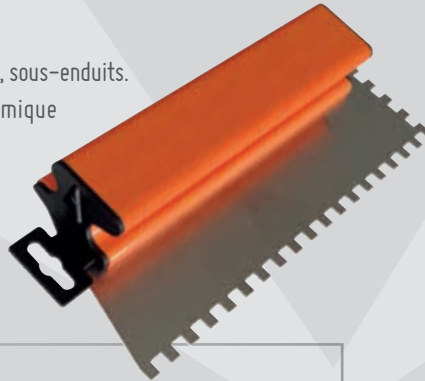

### Façadier I.T.E.



227920  
8x9



227930  
8x8

### Carreleur

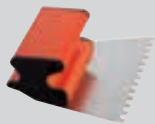

227700  
6x6

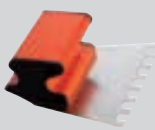

227710  
10x10

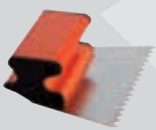

227720  
8x9



227800  
6x6



227830  
8x8

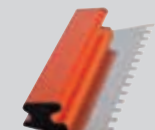

227810  
10x10



227840  
1/2 rond



227820  
8x9

## ERGOLAME® DENTÉ 15 CM

Pour l'encollage des carreaux et faïences.  
Lame inox.

### CARRELEUR



Denture mm	L mm	Ref.	☐
Dents carrées 6 x 6 x 6	150	227700	2
Dents carrées 10 x 10 x 10	150	227710	2
Dents larges pointues 8 x 9	150	227720	2

## LAME ERGOLAME® DENTÉ CARRELEUR

Changement simple avec une clé logée dans l'outil.

### CARRELEUR



Denture mm	L mm	Ref.	☐
Dents carrées 6 x 6 x 6	150	227701	1
Dents carrées 6 x 6 x 6	300	227801	1
Dents carrées 10 x 10 x 10	150	227711	1
Dents carrées 10 x 10 x 10	300	227811	1
Dents carrées 8 x 8 x 8	300	227831	1
Dents pointues 8 x 9	150	227721	1
Dents pointues 8 x 9	300	227821	1
Dents 1/2 rondes Ø 20	300	227841	1
Dents larges pointues 8 x 9	600	227921	1

## ERGOLAME® DENTÉ 30CM

Pour l'encollage des carreaux.  
Lame inox.

### CARRELEUR

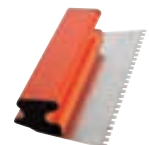

Denture mm	L mm	Ref.	☐
Dents carrées 6 x 6 x 6	300	227800	2
Dents carrées 8 x 8 x 8	300	227830	2
Dents carrées 10 x 10 x 10	300	227810	2
Dents larges pointues 8 x 9	300	227820	2
Dents 1/2 rondes Ø 20	300	227840	2

## ERGOLAME® SPECIAL FAÇADIER

### FAÇADIER

#### ITE



Denture mm	L mm	Ref.	☐
Dents larges pointues 8 x 9	600	227920	2
Dents carrées 8 x 8	600	227930	2

## PERCHE ERGOLAME

Réglable de 1,10 m à 2,10 m. Le réglage de l'angle se fait par 7 positions de 15°. Robuste.

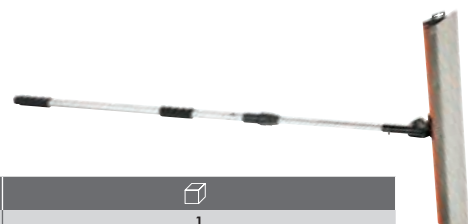

L m	Ref.	☐
1,10 à 2,10	227400	1



16



62



96



120



126



156



188



224



248



254



300



316



340



390



462



488



481



# TRUELLES EXCELLENCE

## TRUELLES EXCELLENCE

### + LE PLUS

- Une lame traversante permettant d'ajuster avec le manche

### QUALITÉS EXCLUSIVES

- Lame en acier haute qualité, traité.
- Patte diamètre 10mm.
- Bouterollage du manche sur un grand nombre de modèles donnant une meilleure résistance au manche et évitant ainsi son éclatement dû aux frappes. Double virole 30 et 22mm

### MANCHE ERGONOMIQUE

- Section 33 mm permettant de faire tourner la truelle pour la projection.
- Essence de bois : hêtre, bois dur issu de forêts renouvelées et gérées.



Vue en coupe de la soie traversante



La soie traverse tout le manche afin de permettre une frappe en bout de manche, sans le détériorer.

Truelles concernées : rondes et carrées.



### TRUELLE ITALIENNE RONDE

Gamme Excellence.  
Soie traversante.

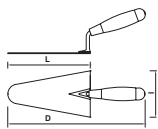

L cm	l cm	D cm	g	Ref.	☐
16	10	28	245	6001160001	1
18	10	31	260	6001180001	1
20	11	33	310	6001200001	1
22	12	35	335	6001220001	1
24	13	37	370	6001240001	1

### TRUELLE TRIANGULAIRE

Gamme Excellence.

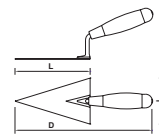

L cm	l cm	D cm	g	Ref.	☐
14	9	25	120	6011140001	1

### TRUELLE ITALIENNE CARRÉE

Gamme Excellence.  
Soie traversante.

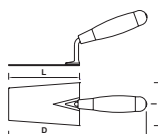

L cm	l cm	D cm	g	Ref.	☐
16	9	28	270	6006160001	1
18	11	31	295	6006180001	1
20	12	33	345	6006200001	1
22	13	35	365	6006220001	1

### TRUELLE LANGUE DE CHAT

Gamme Excellence.

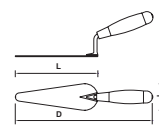

L cm	l cm	D cm	g	Ref.	☐
14	4,5	25	125	6014140001	1
16	5	28	135	6014160001	1
18	5,5	30	140	6014180001	1
20	6,5	32	165	6014200001	1



## TRUELLE SORBY

Gamme Excellence.

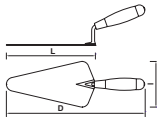

L cm	l cm	D cm	g	Ref.	1
22	11	36	310	6023220001	1
24	12	37	340	6023240001	1
26	13	40	375	6023260001	1

## TRUELLE AMÉRICAINE RONDE

Gamme Excellence.

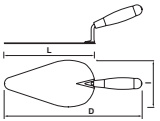

L inch	L cm	D cm	g	Ref.	1
9"	12	36	335	6031090001	1
10"	13	39	370	6031100001	1

## TRUELLE À BRIQUE FAÇON LILLE

Lame biseautée. Gamme Excellence.

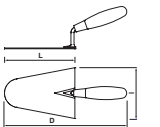

L cm	l cm	D cm	g	Ref.	1
18	13	31	400	6027000001	1

## TRUELLE À BRIQUE FAÇON PARIS

Lame biseautée. Gamme Excellence.

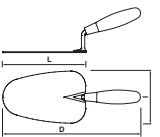

L cm	l cm	D cm	g	Ref.	1
20	13	33	440	6029200001	1

## TRUELLE FAÇON REIMS

Gamme Excellence.

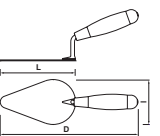

L cm	l cm	D cm	g	Ref.	1
14	9	25	150	6026140001	1
16	10	28	165	6026160001	1

## TRUELLES BERTHELET

### UTILISATION

- Cette truelle est idéale pour dresser les plâtres, après comblement à la truelle classique et séchage partiel du plâtre.
- Utiliser d'abord côté cranté, puis côté lisse pour agrafer.



### CARACTÉRISTIQUES

- 1 côté denté et 1 côté lisse biseauté.
- Manche en bois dur (hêtre)
- Finition Authentique Mob.
- Deux viroles.
- Finition nickelée.



## TRUELLE BERTHELET

1 côté denté - 1 côté lisse biseauté.  
Gamme Authentique Mob.

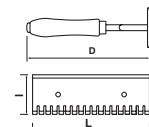

L cm	l cm	D cm	g	Ref.	1
18	6	18,5	285	6062000001	1



16



62



96



120



126



156



188



224



248



254



300



316



340



390



462



488

# TRUELLES FORGÉES

## TRUELLES FORGÉES

### + LES PLUS

- Une truelle sans soudure, forgée en une seule pièce : 1 pièce de la patte à la lame.
- Une résistance inégalée.
- Idéale pour casser les briques alvéolaires.



### CARACTÉRISTIQUES

- Lame monobloc en acier de haute qualité (Chrome Vanadium trempé)
- Lame d'épaisseur décroissante
- 2 viroles : excellente durée de vie du manche
- Manche bois dur haut de gamme (hêtre)
- Poids supérieur aux autres truelles



### TRUELLE FORGÉE RONDE

Gamme forgée 1 pièce pour plus de résistance.

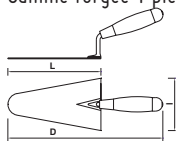

L cm	l cm	D cm	Ref.	
18	10,9	31	6000180501	1
20	11,6	33	6000200501	1
22	12,5	35	6000220501	1

### TRUELLE FORGÉE CARRÉE

Gamme forgée 1 pièce pour plus de résistance.



L cm	l cm	D cm	Ref.	
18	10,5	31	6005180501	1
20	11	33	6005200501	1

### TRUELLE FORGÉE LANGUE DE CHAT

Gamme forgée 1 pièce pour plus de résistance.



L cm	l cm	D cm	Ref.	
14	5	26,5	6018140501	1
16	5	28,5	6018160501	1



## TRUELLES AUTHENTIQUE

### QUALITÉ

- Lame de haute qualité en acier bleui souple et indéformable
- Épaisseur obtenue par laminage
- Dureté 157 daN/mm2
- Patte : diamètre important 10 mm pour une résistance supérieure
- Soudure 2 points de qualité, avec centrage garanti, meulé
- Manche en bois dur (hêtre).

### DOUBLE VIROLE

- Deuxième virole pour ajuster en frappant
- Finition nickelée.



### TRUELLE ITALIENNE RONDE

Gamme Authentique.

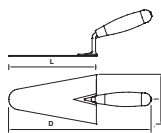

L cm	l cm	D cm	g	Ref.	☐
14	9	25	145	6002140101	1
16	10	27	245	6002160101	1
18	10	30	260	6002180101	1
20	11	33	310	6002200101	1
22	12	35	335	6002220101	1
24	13	37	370	6002240101	1
26	13	39	410	6002260101	1

### TRUELLE TRIANGULAIRE

Gamme Authentique.

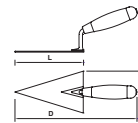

L cm	l cm	D cm	g	Ref.	☐
14	9	25	120	6012140101	1
16	10	28	135	6012160101	1

### TRUELLE ITALIENNE CARRÉE

Gamme Authentique.

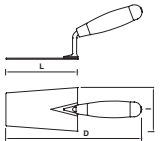

L cm	l cm	D cm	g	Ref.	☐
14	8	25	170	6007140101	1
16	9	28	270	6007160101	1
18	11	31	295	6007180101	1
20	12	33	345	6007200101	1
22	13	35	365	6007220101	1
24	13	37	440	6007240101	1

### TRUELLE LANGUE DE CHAT

Gamme Authentique.

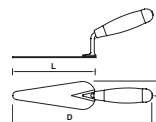

L cm	l cm	D cm	g	Ref.	☐
12	4	23	115	6015120101	1
14	4,5	25	125	6015140101	1
16	5	28	135	6015160101	1
18	5,5	30	140	6015180101	1

### TRUELLE À JOINT PLATE

Forgée 1 pièce pour plus de résistance.  
Gamme Authentique.

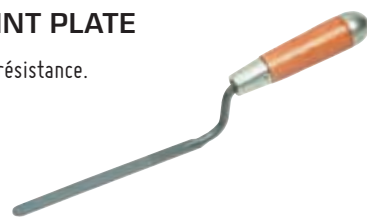
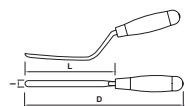

l mm	L cm	D cm	g	Ref.	☐
8	18	22	85	6021080101	1
10	18	24	85	6021100101	1
12	18	26	85	6021120101	1
14	18	28	105	6021140101	1

### TRUELLE À JOINT DEMI-RONDE

Forgée 1 pièce pour plus de résistance.  
Gamme Authentique.

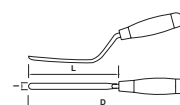

l mm	L cm	D cm	g	Ref.	☐
10	18	24	85	6022100001	1
12	18	26	85	6022120001	1



16



62



96



120



126



156



188



224



248



254



300



316



340



390



462



488



485

# TRUELLES BIMATIÈRE

## TRUELLES BIMATIÈRE

### MANCHE BI-MATIÈRE

- Elastomère : confort
- Polypropylène : résistance



### RÉSISTANCE

- Aux produits chimiques utilisés dans le bâtiment
- Aux intempéries et conditions climatiques extrêmes
- Culot métal pour ajuster en frappant

### ERGONOMIE

- Butée anti-glissement du doigt
- Elastomère confortable qui descend pour protéger la main
- Forme du manche ronde et lisse pour projeter facilement
- Ces truelles sont étudiées pour se nettoyer facilement et ne pas accrocher la saleté

### CARACTÉRISTIQUES

- Lame en acier traité de haute qualité, souple mais indéformable.
- Patte forgée



### TRUELLE RONDE

Manche ergonomique bimatière.

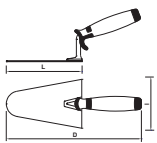

L cm	l cm	D cm	g	Ref.	☐
16	10	28	165	6003160401	1
18	10	32	250	6003180401	1
20	11	34	265	6003200401	1
22	12	36	295	6003220401	1

### TRUELLE TRIANGULAIRE

Manche ergonomique bimatière.

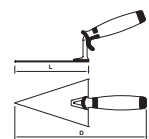

L cm	l cm	D cm	g	Ref.	☐
14	9	26	135	6013140401	1

### TRUELLE CARRÉE

Manche ergonomique bimatière.

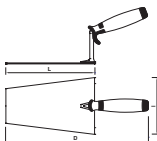

L cm	l cm	D cm	g	Ref.	☐
18	11	32	280	6008180401	1
20	12	34	315	6008200401	1
22	13	36	335	6008220401	1

### TRUELLE LANGUE DE CHAT

Manche ergonomique bimatière.

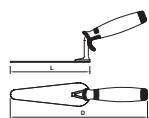

L cm	l cm	D cm	g	Ref.	☐
14	4,5	26	125	6016140401	1
16	5	28	135	6016160401	1
18	5,5	30	140	6016180401	1



# TRUELLES INOX BIMATIÈRE



## TRUELLES INOX BIMATIÈRE

### UTILISATION

■ Dans toutes les situations où l'on souhaite éviter les traces de rouille : enduits de façade, enduits d'intérieur, plâtre, bétons décoratifs, joints, etc.

### LAME INOX

- Lame en acier inoxydable d'épaisseur 1 mm, de haute qualité 4310 (fabriqué en Allemagne)
- Patte forgée Ø 9 mm inox
- Soudure électrique par bossage, invisible, compacte et d'une longévité supérieure à la soudure par points

### MANCHE BI-MATIÈRE

- Résistance aux produits chimiques utilisés dans le bâtiment
- Elastomère confortable qui descend pour protéger la main
- Repose-doigt sur le dessus
- Forme du manche ronde et lisse pour une prise en main efficace
- Bi-matière : les parties nécessitant du grip sont en élastomère et les parties lisses en polypropylène
- Nettoyage facile



Patte soudée par bossage, invisible, compacte et d'une longévité supérieure à la soudure par points

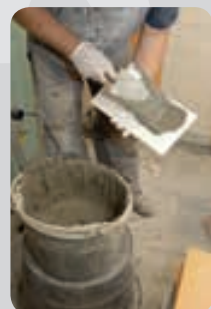

### TRUELLE RONDE INOX MANCHE BIMATIÈRE

Manche ergonomique bimatière Mob.

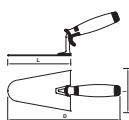

L cm	l mm	D mm	g	Ref.	☐
20	11	34	285	6004200401	1
22	12	36	305	6004220401	1
24	13	38	350	6004240401	1

### TRUELLE CARRÉE INOX MANCHE BIMATIÈRE

Manche ergonomique bimatière Mob.

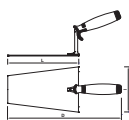

L cm	l mm	D mm	g	Ref.	☐
20	12	34	335	6009200401	1
22	13	36	355	6009220401	1

### STUCATEUR INOX MANCHE BIMATIÈRE

Manche ergonomique bimatière Mob.

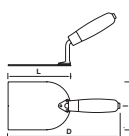

L cm	l mm	D mm	g	Ref.	☐
14	9	26	155	6059160401	1

### TRUELLE TRIANGULAIRE INOX MANCHE BIMATIÈRE

Manche ergonomique bimatière Mob.

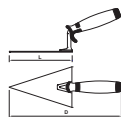

L cm	l mm	D mm	g	Ref.	☐
14	9	26	155	6059160401	1

### TRUELLE LANGUE DE CHAT INOX MANCHE BIMATIÈRE

Manche ergonomique bimatière Mob.

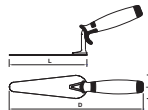

L cm	l mm	D mm	g	Ref.	☐
14	4.5	26	125	6017140401	1
16	5	28	135	6017160401	1

## VOIR AUSSI DANS SECTION « I.T.E. » TRUELLES BI-MATIÈRE MONDELIN

- Design Mondelin.
- Le manche est percé ce qui permet de suspendre la truelle ou d'utiliser une dragonne (travail en hauteur)

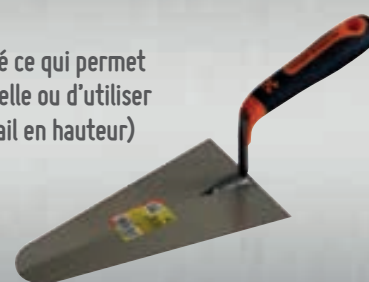

16



62



96



120



126



156



188



224



248



254



300



316



340



390



462



488



487





# 016

## OUTILS UNIVERSELS BÂTIMENT

**P.490**

**| MANUTENTION**



**P.508**

**| AGITATEURS  
MÉLANGEURS**



**P.515**

**| GOULOTTES  
SIGNALISATION**



**P.498**

**| ÉQUIPEMENT DE  
PROTECTION  
INDIVIDUELLE**



**P.510**

**| BACS, BÂCHES**



**P.511**

**| BROSSERIE, BALAIS,  
POUBELLES**



**P.518**

**| PANNEAUX**



**P.505**

**| PULVÉRISATEURS,  
PISTOLETS, DÉCAPEUR  
ET PAPIERS**



## CHARIOT PORTE-PLAQUES PLIABLE 4 ROUES

### + LES PLUS

- Lutte contre les maladies professionnelles
- Très pratique : pliable
- Robuste, haute qualité
- 4 roues caoutchouc dont 2 équipées d'un système de blocage du pivot et du roulage.
- Grande stabilité.

TMS



Chariot plié



### CHARIOT PLIABLE 4 ROUES

Conforme **CE** et à la directive Européenne 2006/42/CE.  
Peinture époxy. 4 roues caoutchouc dont 2 équipées d'un système de blocage du pivot et du roulage.



Dimensions du support cm	Charge maximum kg	kg	Ref.	☐
83 x 32	900	24,5	500560	1
83 x 32	450	21	500570	1

## CHARIOT 2 ROUES

### + LES PLUS

- Lutte contre les maladies professionnelles
- Très pratique sur les chantiers
- 2 poignées orientables et télescopiques de 1,40 m à 2,00 m
- Robuste, haute qualité.

### UTILISATION

- Adapté pour le transport des plaques de plâtre, panneaux de bois...

TMS



### CHARIOT PORTE-PLAQUES 2 ROUES 900 KG

Conforme **CE** et à la directive Européenne 2006/42/CE.  
2 poignées orientables et télescopiques de 1,40 m à 2,00 m.



Dimensions du support cm	Charge maximum kg	kg	Ref.	☐
80 x 21	900	13	500550	1

### CHARIOT PORTE-PLAQUES 2 ROUES 450 KG

Conforme **CE** et à la directive Européenne 2006/42/CE.  
Revêtement caoutchouc à la base pour protéger les matériaux transportés.  
2 poignées plastiques.



Dimensions du support cm	Charge maximum kg	kg	Ref.	☐
21 x 60	450	11,5	500540	1



## CHARIOT DE MANUTENTION

**TMS**



### + LES PLUS

- Plateforme en contreplaqué antidérapant 375 x 410 mm.
- Charge utile : 120 Kg.
- Transport facile
- Lutte contre les maladies professionnelles.
- 4 roulettes multidirectionnelles

### UTILISATION

- Pour la manutention des paquets de carreaux, sacs de ciment, plâtre, colle, radiateur, contenants chargés, etc.



## CHARIOT DE MANUTENTION

Charge utile : 120 Kg.



Longueur plate-forme mm	Largeur plate-forme mm	Charge utile kg	Ref.	
410	375	120	156400	1

## CHARIOT PORTE-SEAU



**TMS**

### + LES PLUS

- Prévient les maladies professionnelles (plus besoin de se baisser)
- Facilement déplaçable grâce aux roues
- Pratique pour le travail en hauteur
- Rapidement réglable grâce aux goupilles clips.
- Porte-seau, pot de peinture...
- Réglable pour 4 dimensions de seaux : Ø 435 mm - Ø 340 mm - Ø 300 mm - Ø 270 mm.
- Charge : 50 kg.
- 4 roues Ø 100 mm (dont 2 équipées de système de freinage).



## CHARIOT PORTE-SEAU PLIABLE

Chariot porte-seau, pots de peintures...



(Seau vendu séparément)



H mm	Charge maximum kg	kg	Ref.	
710	50	7,7	156430	1



16



62



96



120



126



156



188



224



248



254



300



316



340



390



462



488

## DOUBLE VENTOUSE

### + LES PLUS

- Double tête en caoutchouc pour une capacité élevée de 80 kg
- Verrouillage par 2 leviers oscillants, pour une grande fiabilité

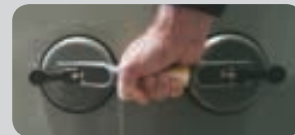

### UTILISATION

- Ventouse de transport double
- Permet de lever les grands carreaux avec facilité
- Pour déplacer des menuiseries vitrées (fenêtres, portes, baies) des vitres, glaces et miroirs, ainsi que des panneaux lisses et surfaces planes
- Crée une poignée pour transporter les appareils à surface lisse sans prise (machine à laver, frigidaire) dont le poids n'excède pas 80kg
- Idéal pour le transport d'objets lourds ayant peu de prise.



### PERFORMANCE

- Adhérence totale, même avec de la poussière
- Capacité : 80kg
- Diamètre de chaque ventouse : 120mm

### CARACTÉRISTIQUES

- Base en aluminium
- Finition peinte grise
- Semelles en caoutchouc
- Longueur totale : 330mm



## DOUBLE VENTOUSE

Permet de lever carreaux, panneaux et vitres de surfaces planes. Ventouse de transport en caoutchouc double. Diamètre de chaque ventouse : 120mm. Capacité : 80kg. Verrouillage par 2 leviers oscillants



Ø mm	Force utile kg	Ref.	📦
120	80	153690	1

## VENTOUSE SIMPLE

Pour la pose ou la dépose des carreaux.



Ø mm	Force utile kg	Ref.	📦
80	11	153700	1



## COINS ROULE-MEUBLES



### UTILISATION

- Permet de déplacer sans effort tout type de charges, sans basculement
- Rend mobile les meubles pleins pendant un chantier de rénovation par exemple
- Lutte contre les maladies professionnelles



### CARACTÉRISTIQUES

- Résistance : 600 kg pour le jeu de 4
- Chaque coin est équipé de 3 roues pivotantes
- Conception en mécano-soudé
- Support avec poignée pour transporter les 4 coins facilement avec 1 main

### JEU DE 4 COINS ROULE-MEUBLES AVEC SUPPORT

3 roues pivotantes.  
Acier mécano-soudé.  
Résistance : 600 kg pour le jeu de 4.



	Dim.	kg	Ref.	
x 4	29x29x39	9,3	114210	1

### JEU DE 4 COINS ROULE-MEUBLES

Résistance : 600 kg pour le jeu de 4. En aluminium moulé. 3 roues pivotantes à simple galet.



	Dim.	kg	Ref.	
x 4	29x29x39	5,2	114200	1

## LÈVE-PORTE

### UTILISATION

- Pour remonter les portes avec facilité pour les dégondrer.
- Utilisation très intuitive, commande au pied - laisse les 2 mains libres pour placer la porte sur ses gonds en face
- Pose du pied : l'avant du pied se pose sur la partie rouge anti-dérapante, le talon se place sur la partie ronde (antidérapante et légèrement concave).



### EXCLUSIF

- La double articulation permet de maintenir la porte parfaitement verticale lorsqu'on lève (mouvements verticaux)
- Le pied antidérapant ne glisse pas, même sur sol dur (carrelage...)
- Charge maxi : 75 KG



### LÈVE-PORTE

Commande au pied - laisse les 2 mains libres - pour soulever les portes avec facilité



L mm	kg	Ref.	
250	770	0114501000	1

### LEVIER À PANNEAUX À BASCULE ET À DÉGONDER LES PORTES

Corps en acier. Bride rigide en acier peint.



Ref.	
502010	1



16



62



96



120



126



156



188



224



248



254



300



316



340



390



462



488

## PATIN ÉLÉVATEUR AVEC CRIC



### UTILISATION

- Permet de soulever et déplacer tous types de meubles sans effort

### CARACTÉRISTIQUES

- Résistance : 240 kg
- Équipé de 4 roues pivotantes double galet
- En acier, peinture époxy
- Manivelle démontable
- Peut être équipé de l'accessoire de levage 114160 pour soulever les charges sans pied ou sans passage
- Hauteur réglable : de 8 à 15 cm.



Manivelle



Palette



Roue



## PATIN ELEVATEUR DE MEUBLES AVEC CRIC

Permet de soulever et déplacer tous types de charge sans effort, jusqu'à 240 kg. 4 roues. Hauteur réglable : de 8 à 15 cm.



L cm	Hauteur cm	Charge maximum kg	kg	Ref.	☐
66	8 > 15	240	6	114150	1

## ACCESSOIRE DE LEVAGE

Pour soulever les charges sans pied ou sans passage. Adaptable sur patin élévateur réf. 114150. En acier, peinture époxy.



kg	Ref.	☐
3	114160	1

## PATIN ROULE-MEUBLES SEUL

Permet de déplacer tous types de meubles sans effort. Résistance : 240 kg. Equipé de 4 roues pivotantes double galet. En acier, peinture époxy.



L cm	Charge maximum kg	kg	Ref.	☐
66	240	6,4	114170	1





## LÈVE-CHARGES À TREUIL

### UTILISATION

- Charge maximale d'utilisation : 100 kg
- Hauteur maximale de pose (Sol/Plateforme) : 3.50 m
- Hauteur de chargement : 1.40 m
- Plateforme en bois multiplis de 9 mm : 795 x 375 mm
- 2 sangles fournies avec l'appareil
- Système de sécurité constitué de 2 câbles : 1 câble de travail et 1 câble de sécurité anti-chute.
- Système de freinage intégré au treuil anti-retour fixé sur la poignée de guidage.
- Bon dégagement de la manivelle pour un meilleur contrôle
- Équipé de 3 roues freinées Ø 125 mm
- Empattement : 1.05 x 1.05 x 1 m
- Poids de l'appareil : 29 kg



## LÈVE-CHARGES À TREUIL

CMU : 100 kg.  
 Hauteur maximale de pose : 3.50 m.  
 Hauteur de chargement : 1.40 m.  
 Empattement : 1.05 x 1.05 x 1 m.

kg  
29

Ref.  
6550065001

1



16



62



96



120



126



156



188



224



248



254



300



316



340



390



462



488

## ETAI 3<sup>ÈME</sup> MAIN

### + LES PLUS

- Fonction 3<sup>ème</sup> main
- Réglage précis et rapide
- Equipé d'un verrou de sécurité pour une sécurisation optimale

### UTILISATION

- Pour maintenir des charges dans les véhicules
- Pour maintenir au plafond ou en sous-pente divers éléments : rails, tasseaux, lambris PVC...
- Adapté aux métiers : plaquiste ou jointoyeur placo, peintre, menuisier

### CARACTÉRISTIQUES

- Charge admissible :  
80 kg à 90° et 30 kg à 55°.

Patin articulé



Verrou de blocage



## ÉTAI 3<sup>ÈME</sup> MAIN

Pour un réglage précis et rapide.  
Equipé d'un verrou de sécurité  
pour une sécurisation optimale.



Extensible m	Ref.	📦
0,75 -> 1,25	504800	1
1,60 -> 2,90	504810	1



## SANGLE FASTER

### + LES PLUS

- Ultra-rapide : enroulement automatique de la sangle grâce au bouton rouge
- Ajustage rapide de la tension grâce au cliquet
- Sangle prête à l'emploi, déjà montée sur le cliquet

### UTILISATION

- Idéale pour la fixation fiable et rapide d'objets.
- Idéale pour maintenir les charges à l'intérieur des véhicules.

### CARACTÉRISTIQUES

- Crochet métal rond en double J
- Sangle 100% polyester haute qualité
- Conformité à la norme NF EN 12195-2
- Brevet déposé PAT US 7503736



## SANGLE FASTER A ENROULEUR AUTOMATIQUE

Sangle 100% polyester haute qualité - crochet métal rond en double J - système à cliquet - enroulement automatique - NF EN 12195-2.



L mm	l mm	TMU capacité d'amarrage / LC daN	Ref.	📦
1,8	25	300 daN	6299181001	1
3	50	600 daN	6299301001	1

## SANGLE À CLIQUET 5 M X 35 MM

Conforme à la norme EN 12195-2. Résistance à la rupture 3000 kg. TMU (Tension maximale d'utilisation) 900 kg. Longueur : 4,7 + 0,3 m avec 2 crochets.



Longueur m	Largeur mm	Ref.	📦
5	35	825020	1

## SANGLE À CLIQUET 9 M X 50 MM

Conforme à la norme EN 12195-2. Résistance à la rupture 6000 kg. TMU (Tension maximale d'utilisation) 2000 kg. Longueur : 8,5 m + 0,5 m avec 2 crochets.

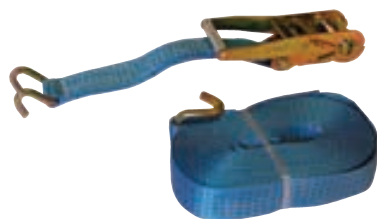

Longueur m	Largeur mm	Ref.	📦
9	50	825010	1

## SANGLE À CLIQUET 5 M X 25 MM

Conforme à la norme EN 12195-2. Résistance à la rupture 1200 kg. TMU (Tension maximale d'utilisation) 400 kg.



Longueur m	Largeur mm	Ref.	📦
5	25	825000	1

## LOT DE 2 TENDEURS

Avec cavalier de suspension.



	Longueur m	Ø mm	Ref.	📦
2 PCS	1	10	825118	1



16



62



96



120



126



156



188



224



248



254



300



316



340



390



462



488

**SERRE-JOINT RAPIDE**

Tête en nylon et fibre de verre.  
Tige en acier trempée.  
Serrage « réversible ».  
Puissance de serrage : 1500 N





Taille	Ref.	
15	308110	1
30	308120	1
45	308130	1

**POULIE TYPE "CLIC"**

Avec système de blocage automatique. Finition : zinguée bichromatée. Capacité du point d'accrochage : 160 kg. Rea nylon Ø : 210 mm. S'utilise avec cordes de Ø 20 à 30 mm.



 kg	Ref.	
3,4	824260	1

## TAPIS PROTECTION GENOUX PROTECH

**LE CONFORT EN TOUTE LIBERTÉ**

- Pour ceux qui ne veulent pas porter de genouillères.
- Poignée de transport pratique.
- Protection des genoux type 3 (non fixés au corps).
- Dimensions : 675x210x25 mm.
- Composition chimique : Mousse à cellule fermée, densité supérieure



- Caoutchouc NBR vulcanisé antidérapant
- Excellente résistance aux liquides dérivés du pétrole (essence...) et aux huiles.
- Résistance à haute température.
- Protection de l'environnement : fabrication propre : 0% CFCs, 0% HFCs, 0% COVs, 0%
- Composition garantie sans PVC
- Ne dégage aucune substance nocive : conformité à Reach.
- Pas de risque allergique : 0% latex.

**TAPIS PROTECTION GENOUX PROTECH**

Protection des genoux type 3 (non fixés au corps)  
Poignée de transport  
Dimensions : 675x210x25 mm



Dim.	 kg	Ref.	
685x215x25	540	642300001	1

# GENOUILLÈRES GEL COMFORT

## LA POSITION À GENOUX

Rotules non protégées  
= risque de pathologies.  
Ex : kyste du carreleur

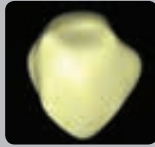

Nécessité de :

- Répartir les poids sur une large surface
- Absorber les pressions
- Amortir les chocs



## + LES PLUS

- Double attache
- Cœur en gel technique injecté en nid d'abeille.
- Pas de fuite.
- Semelle à crampons

### STRUCTURE

- 1 Élastomère d'approche isotherme
- 2 Forte épaisseur de mousse de copolymère, fermée haute densité
- 3 Large carré de gel technique de qualité supérieure (Diphenylmethane-4,4'-diisocyanate) injecté en nid d'abeille
- 4 Textile nylon 1680 deniers

### STABILITÉ

- Version COMFORT : Semelle à lamelles indépendantes pour caler le genou au sol sur tout terrain.
- La gomme medium ne glisse pas.
- La semelle translucide ne marque pas les sols.

### DOUBLE ATTACHE

- Fixation rapide par lanière élastique avec velcro ajustable et/ou enfilage par le pied avec une bande stretch aérée et large de 4,5 cm.



Sol plat



Terrain accidenté

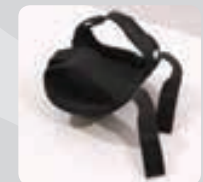

## GENOUILLÈRES GEL COMFORT

Semelle à lamelles élastomère tout terrain.  
Double attache par Velcro et/ou bande stretch.  
Gel technique injecté en nid d'abeille. EN 14404. CE.



Ref.

6193000001



1

## GENOUILLÈRES GEL

Genouillères de protection avec rembourrage gel.  
Revêtement antidérapant.  
2 sangles élastiques de 65 mm.  
Certifiées conformes DIN EN 14404. La paire.



Ref.

154130



1

## GENOUILLÈRES POLYURÉTHANE JAUNE

Sangle réglable.  
La paire.



Ref.

154150



1



16



62



96



120



126



156



188



224



248



254



300



316



340



390



462



488



499

## GANTS NYLON ENDUIT LATEX



### UTILISATION

- Pour la construction et les travaux de construction, le béton et la manutention de brique.

### QUALITÉ

- Enduction latex offrant une excellente adhérence
- Fibre : nylon
- Dos aéré pour éviter l'échauffement des mains en milieux chauds
- Montage: type tricoté une pièce avec poignet élastique.

### NORMES

- Conforme aux normes Européennes EN 420 et EN 388.
- Protection 3131



### GANTS NYLON ENDUCTION LATEX

Conforme aux normes Européennes EN 420 et EN 388. Protection 4141. CE. Gant tricoté 100% nylon. Enduction : latex.



**MAÇON**

Taille	Sachet 10 paires		Cavalier 1 paire	
	Ref.	📦	Ref.	📦
8	801305	1	801304	1
9	801303	1	801302	1
10	801301	1	801300	1

### GANTS POLYAMIDE ENDUCTION NITRILE

Conforme aux normes Européennes EN 420 et EN 388. Protection 2121. CE. Excellente préhension, résistant à l'abrasion. Gant tricoté 100% polyamide. Enduction nitrile. Résistant à l'abrasion. Dextérité accrue. Utilisation : travaux précis, manipulations de pièces grasses.



Taille	Sachet 10 paires		Cavalier 1 paire	
	Ref.	📦	Ref.	📦
9	801293	1	801294	1
10	801292	1	801292	1
	801291	1	801290	1

### GANTS PROTECTION CHIMIQUE ENDUCTION NITRILE



Conforme aux normes Européennes EN 420 et EN 388. Protection 3121. Excellente préhension, résistant aux produits chimiques. Protection aux huiles. CE. Gant tricoté 100% polyamide. Enduction nitrile.



**CARRELEUR**

Taille	Sachet 10 paires		Cavalier 1 paire	
	Ref.	📦	Ref.	📦
9	801321	1	801320	1

### GANTS "DOCKERS"



Conforme aux normes Européennes EN 420 et EN 388. Protection 4111. CE. Forme américaine, bouts de doigts et renfort dos en croûte de porc, dos et manchette en toile coton. Résistant à l'abrasion. Gant de protection mécanique renforcée d'usage général. Utilisation : entreposage, magasinage, manutention générale, caisses, cartons.



Taille	Sachet 12 paires		Cavalier 1 paire	
	Ref.	📦	Ref.	📦
10	801201	1	801200	1

## GANTS "CANADIENS"



Conforme aux normes Européennes EN 420 et EN 388. Protection 3123.CE . Croûte supérieure de bovin renforcée. Dos et manchette toile.



Taille	Sachet 12 paires		Cavalier 1 paire	
	Ref.		Ref.	
10	801211	1	801210	1

## GANTS FLEUR ET CROÛTE DE BOVIN



Conforme aux normes Européennes EN 420 et EN 388. Protection 2121. CE . Coupe américaine, élastique de serrage sur le dos. Gant de protection mécanique renforcée d'usage général. Utilisations: caristes, conducteurs d'engins, manutention de caisses en bois.



Taille	Sachet 10 paires		Cavalier 1 paire	
	Ref.		Ref.	
10	801221	1	801220	1

## GANTS PVC ROUGE SUR SUPPORT COTON, DOS AÉRÉ



Conforme aux normes Européennes EN 420 et EN 388. Protection 3131.CE . Gant en coton enduit PVC rouge. Dos aéré. Poignet tricoté. Utilisation : métiers du bâtiment.



Taille	Sachet 10 paires		Cavalier 1 paire	
	Ref.		Ref.	
9	801231	1	801230	1

## GANTS LATEX CRÊPÉ VERT



Conforme aux normes Européennes EN 420 et EN 388. Protection 1121. CE. Gant latex trempé crêpé sur support coton jersey, dos aéré pour une meilleure ventilation de la main, poignet bord côte. Gant de protection mécanique renforcée d'usage général. Utilisation : pose de clôtures, travaux en carrière, matériaux de construction, bâtiment, manipulation de plastique et objets glissants.



Taille	Sachet 12 paires		Cavalier 1 paire	
	Ref.		Ref.	
10	801251	1	801250	1

## GANTS ANTI-COUPURE



Conforme aux normes Européennes EN 420 et EN 388. Protection 4542. CE. Gant polyuréthane sur support polyéthylène HD, dos aéré pour une meilleure ventilation de la main, poignet élastique. Gant de protection contre les coupures niveau 5. Utilisation : manipulation du verre et de matériaux coupants.



Taille	Sachet 10 paires		Cavalier 1 paire	
	Ref.		Ref.	
10	801311	1	801310	1

## GANTS PVC ROUGE



Conforme aux normes Européennes EN 420 et EN 388. Protection 3131.CE . Gant en PVC rouge sur support coton. Utilisation : manutention de produits liquides ou chimiques, maçonnerie, entretien... Grande longueur.



Taille	Longueur cm	Sachet 10 paires		Cavalier 1 paire	
		Ref.		Ref.	
9	36	801241	1	801240	1

## GANTS LATEX BLEU



Sur jersey coton. Conforme aux normes Européennes EN 420, EN 388 et EN 374. Protection 3131.CE . Bonne dextérité grâce à la souplesse du latex naturel. Bonne résistance à de nombreux acides dilués et détergents. Confort du flockage coton. Utilisation principale : nettoyage.



Taille	Sachet 10 paires		Cavalier 1 paire	
	Ref.		Ref.	
9	801271	1	801270	1
10	801272	1		

## GANTS COTON



Conforme à la norme EN 420. Toile coté croisé avec poignée tricot. Pour risque: mineurs uniquement : manipulations de petites pièces en milieu sec, assemblage, nettoyages salissants...



Taille	Cavalier 1 paire	
	Ref.	
9	801260	1

## GANTS À USAGE UNIQUE



Pour risques minimales. CE. Grande finesse pour une bonne sensibilité.



Taille	Sachet de 10		Boîte de 100	
	Ref.		Ref.	
10	801280	1	801281	1



**MASQUE D'HYGIÈNE**

Pince-nez métallique. Cet article n'est pas un équipement de protection individuelle. Lot de 5.



Cavalier de 5	
Ref. 801870	1

**MASQUE RESPIRATOIRE PROTECTION FFP1**

Testé contre l'allergie. Pince-nez aluminium. Conforme à la norme EN149. Protection des voies respiratoires. Utilisation pour ponçage, meulage, poussières de métaux d'oxyde de fer, de charbon, de bois. Protection FFP1 contre les particules solides non toxiques jusqu'à 4,5 fois la côte limite hygiénique.



Cavalier de 5		Boîte de 20	
Ref. 801881	1	Ref. 801882	1

**MASQUE RESPIRATOIRE PROTECTION FFP2**

Coussinet nasal avec soupape. Utilisation pour ponçage, meulage, poussières de métaux ferreux, charbon fibre etc... Protection FFP2 contre les particules solides et liquides faiblement toxiques jusqu'à 10 fois la côte limite hygiénique.



Cavalier de 5		Boîte de 10	
Ref. 801862	1	Ref. 801863	1

**MASQUE RESPIRATOIRE PROTECTION FFP3**

Avec soupape d'expiration. Utilisation pour ponçage, meulage, poussières de métaux ferreux, fibres et fumée de métaux etc... Protection FFP3 contre les particules solides et liquides toxiques jusqu'à 50 fois la côte limite hygiénique avec valve.



Cavalier de 5	
Ref. 801865	1

**SERRE-TÊTE ANTI-BRUIT**

Atténuation moyenne : 25 dB. CE.



Ref. 801810	1
----------------	---

**ARCEAU ANTI-BRUIT**

Conforme à la norme EN352-2. Arceau très léger et confortable. Atténuation moyenne : 23 dB. CE.



Ref. 801820	1
----------------	---

**LUNETTES MASQUE MONTURE PVC SOUPLE**

Aération par perforation latérale. Maintien par élastique de serrage réglable. Écran en polycarbonate épaisseur 1,7 mm incolore. EN170. CE. Impact moyenne énergie.



g 60	Ref. 801890	1
---------	----------------	---

**LUNETTES DE PROTECTION A BRANCHES REGLABLES**

Nylon et polycarbonate. Protection latérale monobloc.



Ref. 801891	1
----------------	---



## CASQUE DE CHANTIER BRENNUS

### CARACTÉRISTIQUES

- Calotte en polyéthylène moulée sous pression avec aérations réglables type BTP
- Harnais comportant :
  - une coiffe en polyéthylène basse densité,
  - un bandeau de tour de tête avec serre-nuque à glissière, en polyéthylène basse densité, amovible et réglable de 53 à 63 cm, monté avec une garniture de confort 32 cm
- Coloris : blanc, jaune, vert, bleu, rouge
- Poids : 330 g
- Durée de vie : 36 mois
- Le casque de protection est conforme à la norme NF EN 397
- Résistance aux très basses températures, -20°C

### UTILISATION

- Casque de protection destiné aux divers métiers du bâtiment, des travaux publics et de l'industrie.



## CASQUE DE CHANTIER BRENNUS

Conforme à la norme EN 397. Avec système d'aération et support de visière.



Coloris	Ref.	☐
Blanc	801700	5
Bleu	801710	5
Jaune	801720	5
Rouge	801740	5
Vert	801750	5

## JUGULAIRE POUR CASQUE BRENNUS

En cuir.



Longueur mm	Ref.	☐
12	801800	10

## CASQUE DE CHANTIER DIÉLECTRIQUE

Conforme à la norme EN 397. Diélectrique (440Va). Coiffe textile. Bande anti-sueur. Avec serrage automatique.



Coloris	Ref.	☐
Blanc	801760	1

## CASQUE DE CHANTIER

Conforme à la norme EN 397. Avec support de visière.



Coloris	Ref.	☐
Blanc	801900	4
Bleu	801910	4
Jaune	801920	4
Rouge	801940	4

## ECRAN DE PROTECTION

En acétate, avec coiffe réglable support écran.



Ref.	☐
801840	1



16  
62  
96  
120  
126  
156  
188  
224  
248  
254  
300  
316  
340  
390  
462  
488

### COMBINAISON POLYPROPYLENE AÉRÉE

Avec cagoule attenante, élastique poignets et pieds. Fermeture à glissière.



Taille	Ref.	
3	801630	1
4	801640	1

### BRASSARD DE SÉCURITÉ

Brassard orange bande rétro réfléchissante.



Ref.	
801520	1

### GILET DE SÉCURITÉ

Gilet en maille fluo jaune avec boudrier rétro réfléchissant de 50 mm. Norme Européenne - Classe II.





Ref.	
801540	1

### JERRICAN MÉTALLIQUE

Pour le transport d'hydrocarbures. Couleur : vert. En acier épaisseur 0,8 mm, haute résistance.



Contenance L	Longueur mm	Largeur mm	Hauteur mm		kg	Ref.	
10	390	130	282	2,7	864000	1	
20	468	165	345	4,2	864010	1	

### JERRICAN PLASTIQUE

Homologué pour le transport d'hydrocarbures (LNE G060421). Bec verseur logé dans le jerrican. En polyéthylène rouge.



Contenance L	Longueur mm	Largeur mm	Hauteur mm	Ref.	
5	321	178	182	864100	1
10	321	178	301	864110	1
20	350	230	365	864120	1

### BALADEUSE PVC AVEC PINCE

Avec manche plastique isolant et anti-choc noir. Grille de protection métallique pivotante pour un remplacement aisé de l'ampoule. Réflecteur enveloppant 180° en tôle. 5 m de câble H05W-F 2x0,75. Crochet de suspension tournant. Équipée d'une pince à montage souple pour un meilleur confort d'utilisation. Avec interrupteur. Pour ampoule 60 W (non fournie), douille E27.



Ref.	
865200	1

### ENROULEUR PROLONGATEUR ÉLECTRIQUE 25 M CAT. A

25 m de câble H05 VVF 3G 1,5 catégorie A, support plastique incassable, équipé de 4 prises NF 230 V avec protection contre jets d'eau IP44 et protection enfants. Norme NF C61-720 avec disjoncteur de sécurité.



Ref.	
865100	1

### ENROULEUR PROLONGATEUR ÉLECTRIQUE 40 M

40 m de câble H07 RNF 3G 2,5 support plastique incassable, équipé de 3 prises NF 230 V avec protection contre jets d'eau IP44 et protection enfants. Norme NF C61-720 avec disjoncteur de sécurité. Utilisation en chantiers extérieurs.



Ref.	
865130	1

### ENROULEUR PROLONGATEUR ÉLECTRIQUE 25 M CAT. B

25 m de câble H07 RNF 3G 1.5 catégorie B, support plastique incassable, équipé de 3 prises NF 230 V avec protection contre jets d'eau IP44 et protection enfants. Norme NF C61-720 avec disjoncteur de sécurité.



Ref.	
865140	1

## PULVÉRISATEUR INDUSTRIEL

### + LES PLUS

- Réservoir en polypropylène résistant aux produits chimiques et aux solvants, utilisation possible avec des produits acides ou des produits pétroliers (huiles et hydrocarbures)
- Joints viton qui résistent à tous les produits corrosifs
- Niveau de remplissage visible avec indicateur de niveau
- La base du pulvérisateur peut servir d'enrouleur pour le tuyau.

Livré avec :

- 2 tuyaux : 1 pour les produits acides, 1 pour les produits pétroliers,
- 2 buses de rechange :  
buse blanche : toutes applications, débit 0,55 l/mn,  
1 buse noire : pour produits phytosanitaires (jardinage, agriculture) débit 0,40 l/mn,
- 1 courroie de transport en bandoulière.



### PULVÉRISATEUR INDUSTRIEL IK 1,5

Capacité totale : 1,5 litres  
Capacité utile : 1 litre.



Capacité totale L	Capacité utile L	Ref.	
1,5	1	853020	1

### PULVÉRISATEUR INDUSTRIEL IK 6

Capacité totale : 6 litres  
Capacité utile : 4 litres.



Capacité totale L	Capacité utile L	Ref.	
6	4	853060	1

### PULVÉRISATEUR INDUSTRIEL IK9

Capacité totale : 8,3 litres  
Capacité utile : 6 litres.



Capacité totale L	Capacité utile L	Ref.	
8,3	6	853090	1

### PULVÉRISATEUR INDUSTRIEL IK12

Capacité totale : 10,5 litres  
Capacité utile : 8 litres.  
Double courroie pour le transport sur le dos.



Capacité totale L	Capacité utile L	Ref.	
10,5	8	853120	1

### PIÈCES POUR PULVÉRISATEUR INDUSTRIEL



	Ref.	
Kit de réparation pour IK 1,5	853150	1
Kit de réparation pour IK 6-9-12	853160	1
Collerette renfort pour IK 6-9-12	853170	1
Chambre complète pour IK 6-9-12	853180	1
Coude avec buse pour IK 6-9-12	853190	1
Poignée complète pour IK 6-9-12	853200	1
Pochette de 2 buses (1 blanche + 1 noire) pour IK 1,5-6-9-12	853210	1
Tuyau	853260	1

### PULVÉRISATEUR 5 LITRES "POLITA 7"

Pulvérisateur à pression préalable. Capacité utile : 5 litres. Réservoir en polypropylène injecté avec indicateur de niveau. Entretien aisé. Démontage de la chambre de pression sans l'aide d'outil. Joint de la manette, de la soupape et de la chambre de pression en "viton". Soupape de sécurité tarée à 3 bars avec fonction dépressurisation. Lance en fibre PVC. Livré avec une buse conique. Bon rapport qualité prix.



Capacité totale L	Capacité utile L	Ref.	
6,8	5	854050	1



16



62



96



120



126



156



188



224



248



254



300



316



340



390



462



488

## PISTOLET À CARTOUCHE



### UTILISATION

- Pour cartouches de 310 ml de silicone, colle, mastic...  
On les utilise pour faire des joints d'étanchéité, joint de façade, de menuiserie. Le mastic-colle convient au bois, métal, céramique, carrelage, béton, polystyrène et au plâtre.

### QUALITÉ

- Modèle professionnel pour usage intensif.
- Corps en acier.
- Poussoir à 2 axes en aluminium, poignée ergonomique en aluminium peint.



## PISTOLET POUR CARTOUCHES SÉRIE PROFESSIONNELLE

Pour cartouches de 310 ml de silicone, colle, mastic...  
Modèle professionnel pour usage intensif.  
Corps en acier. Poussoir à 2 axes en aluminium, poignée ergonomique en aluminium peint.  
Référence Mondelin.



L cm	Ref.	📦
24	153720	1

## PISTOLET SQUELETTE

Pour cartouches de 310 ml de mastic, silicone et colle. Corps et gâchette métalliques. Référence Mondelin.

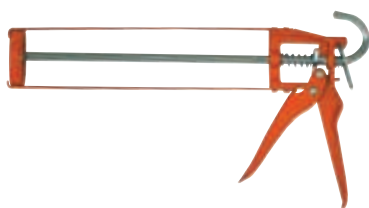

L cm	Ref.	📦
24	153710	1

## PISTOLET À CARTOUCHES TAJIMA® CONVOY JUST

Système à double transmission pour un écoulement de produit homogène et fiable. Interruption automatique de l'écoulement de produit dès que vous relâchez la pression sur la poignée. Corps tournant permet un angle optimal entre la buse de la cartouche et la surface. Pour des cartouches de 310 ml de silicone, colle, mastic... Référence Mondelin.



	Poignée	Ref.	📦
«Convoy Just»	Plastique	153730	1

## PISTOLET À CARTOUCHES TAJIMA® CONVOY SUPER



Système à double transmission pour un écoulement de produit homogène et fiable. Interruption automatique de l'écoulement de produit dès que vous relâchez la pression sur la poignée. Corps tournant permet un angle optimal entre la buse de la cartouche et la surface. Pour des cartouches de 310 ml de silicone, colle, mastic... Référence Mondelin.



	Poignée	L cm	Ref.	📦
«Convoy Super»	Aluminium	0	153740	1

## PISTOLET À COLLE

Accessoires : 2 embouts + 1 poussoir de rechange.  
Référence Mob.



L cm	Ref.	📦
23	6373021001	1
Embouts 5 pcs	6373051001	1



## PISTOLET TUBULAIRE PRO

Utilisé comme un pistolet à cartouche (colle, mastic, silicone) ou garni directement - 4 accessoires : pelle de remplissage / 2 embouts à rejoiner / 1 embout faïence / 1 poussoir. Référence Mob.



L mm	Ref.	📦
380	6373011001	1
Embouts 5 pcs	6373051001	1





## DÉCAPEUR THERMIQUE HL 2010 E

Cet appareil est conçu pour un fonctionnement manuel et en poste fixe. Il peut s'utiliser pour :

- Décaper
- Façonner des plaques
- Dessouder des cartes à circuits imprimés
- Souder du plastique
- Faire sécher du mastic, accélérer les collages et les distorsions
- Enlever de la peinture
- Dégeler
- Rétracter des câbles.
- Braser des tubes.....



**Position 1 :** Débit d'air : 150 l/min. Température : 50°C  
**Position 2 :** Débit d'air : 300 l/min. Température : 50-630 °C.  
**Position 3 :** Débit d'air : 500 l/min. Température : 50-630 °C

### Possibilité de réglage :

- Réglage de la température par poussoir, par palier de 10°C.
- Commande du ventilateur par un interrupteur à 3 positions.
- Position air froid pour refroidir rapidement les buses avant de les changer.

### Équipement :

- Régulation électronique de la température.
- Affichage par écran LCD de la température réelle.
- Double protection contre les surchauffes (thermostat et fusible thermique).
- Poignée soft ergonomique.
- Support soft anti dérapant.
- Entrée d'air munie d'une grille de protection.
- Câble caoutchouc grande résistance.

Puissance : 2000 W.

## DÉCAPEUR THERMIQUE HL 2010 E

Puissance : 2000 W.  
 3 positions de température. Appareil à régulation électronique avec interrupteur à réglage continu et écran de contrôle de température.



Ref.	Quantité
862010	1

## GRATTOIR TAJIMA®

Tête en aluminium. Manche renforcé avec extrémité en acier pouvant servir de zone de frappe. La lame de 18 x 0,6 mm permet de racler précisément. Lames de rechange réf. 103548. Livré avec 3 lames de rechange.



Ref.	Quantité
101338	1

## TOILE ÉMÉRI

Pochette de 4 feuilles 230 x 280 mm pour polissage des métaux ferreux ou non : acier, fonte, cuivre...



Grain	Ref.	Quantité
Fin 0	101960	10
Moyen 1	101970	10
Gros 3	101980	10

## PAPIER ANTI-ENCRASSANT

Pochette de 4 feuilles 230 x 280 mm pour peintures, vernis, laques, moulures, travaux soignés en ébénisterie.



Grain	Ref.	Quantité
Fin 280	101931	10
Moyen 220	101941	10
Gros 150	101951	10

## PAPIER CORINDON

Pochette de 4 feuilles 230 x 280 mm pour bois, polyester, matériaux durs, agglomérés.



Grain	Ref.	Quantité
Fin 120	101871	10
Moyen 80	101881	10
Gros 50	101891	10

## PAPIER SILEX

Pochette de 4 feuilles 230 x 280 mm pour plâtre, enduits, apprêts, bois tendres et vieilles peintures.



Grain	Ref.	Quantité
Fin 0	101841	10
Moyen 2	101851	10
Gros 4	101861	10



16



62



96



120



126



156



188



224



248



254



300



316



340



390



462



488



# AGITATEURS - MÉLANGEURS

## AGITATEUR ÉLECTRIQUE TECMIX

### UTILISATION

- Permet de mélanger efficacement le produit en le rendant très homogène.
- Gain de temps appréciable.

### 2 PUISSANCES

- Modèle 1250 W, couple moteur 21Nm, 1 vitesse, volume 80L.
- Modèle 1600 W, couple moteur 45Nm, 2 vitesses, volume 200L.

### COMPATIBILITÉ

- Filetage arbre interne : standard M14.



Fouet  
881313



A disque  
881312



Hélice double  
881315 / 881317 / 881319



Hélice triple  
881311

### AGITATEUR ÉLECTRIQUE TECMIX 1250

Puissance : 1250 W. 230 V. - Couple du moteur : 21 Nm.  
Variateur électronique de 250 à 1000 tr/mn.  
Convient pour malaxer tout produit de moyenne à forte viscosité : peintures, vernis, colles, lasures, mastics et mortiers, jusqu'à un volume de 80 l. Livré avec une hélice Ø 120 mm réf 881317.



Puissance W	Variateur électronique tr/mn	Volume maxi Litre	Ø hélice mm	kg	Ref.	📦
1250	250 à 1000	80	120	5	881310	1

### MÉLANGEUR À DISQUES POUR COLLES

Le disque supérieur pousse la matière vers le bas pour éviter les éclaboussures. Le disque inférieur tourne dans l'autre sens et renvoie la matière vers le haut. Convient pour les peintures murales, peintures-émulsions, colles à carrelage et colles à papiers-peints. La bague inférieure protège le récipient. Filetage M14.



Longueur mm	Ø mm	Ref.	📦
600	140	881312	1

### AGITATEUR ÉLECTRIQUE TECMIX 1600

Puissance : 1600 W. 230 V. - Couple du moteur : 45 Nm.  
2 vitesses avec variateur électronique de 150 à 400 et 250 à 700 tr/mn. Convient pour malaxer les produits à forte viscosité : béton, ciments, enduits à la chaux, jusqu'à un volume de 200 l. Livré avec une hélice Ø 160 mm réf 881319.



Puissance W	Variateur électronique tr/mn	Volume maxi Litre	Ø hélice mm	kg	Ref.	📦
1600	150 à 400 ou 250 à 700	200	160	8	881300	1

### MÉLANGEUR À HÉLICE DOUBLE POUR MATÉRIEAUX VISQUEUX

L'hélice double transporte la matière de bas en haut. Convient pour des matériaux épais et visqueux : colles à carrelage, mortiers, produits de jointoiment, enduits, chapes. Mélange rapide et intensif. La bague inférieure protège le récipient. Filetage M14.



Longueur mm	Ø mm	Ref.	📦
600	120	881317	1
600	140	881315	1
600	160	881319	1

### MÉLANGEUR FOUET POUR MATÉRIEAUX LIQUIDES

Le fouet dégage une haute force d'aspiration et empêche l'introduction d'air, ce qui assure un mélange très homogène. Convient pour les colles et les mastics. Filetage M14.



Longueur mm	Ø mm	Ref.	📦
600	120	881313	1

### MÉLANGEUR À HÉLICE TRIPLE POUR MORTIERS

L'hélice triple mélange la matière de bas en haut. Convient pour des matières très lourdes et très visqueuses : mortiers, béton, ciment, chaux, crépis et chapes. Mélange rapide et intensif. La bague inférieure protège le récipient. Filetage M14.



Longueur mm	Ø mm	Ref.	📦
600	140	881311	1



## MÉLANGEURS

### CARACTÉRISTIQUES

- Adaptable sur perceuse.
- Livré avec embouts plastiques pour présentation sur broche.



### GAMME

Une large gamme de mélangeurs pour tout type d'utilisation :

- Hélice hélicoïdale Pro : très robuste pour usage intensif. Pour matériaux épais à forte viscosité, mortier, enduits et mortiers de finition, chaux, béton, ciment, ragréage, isolation thermique et phonique.
- Hélice hélicoïdale Ultra : pour matériaux épais à forte viscosité, enduits et mortiers de finition, colles à carrelage, plâtre, chaux, enduits au ciment, ragréage béton.
- Hélice conique Speed : pour produits liquides, à faible viscosité, peintures, colles, enduits chimiques.
- Forme fouet : pour colle, liquide d'isolation
- Hélice plastique : pour peinture murale, vernis et peinture émulsion.

### HÉLICE HÉLICOÏDALE PRO



Usage intensif. Pour mortier, enduits et mortiers de finition, chaux, béton, ciment, ragréage, isolation thermique et phonique.

	Quantité à mélanger kg	Vitesse en charge conseillée en tr/mn	Puissance minimal de la perceuse en W	Longueur totale en mm	Ø base mm	Ref.	
120 S	15 - 25	400/500	900	590	120	881040	1
140 S	25 - 40	200/300	1000	590	135	881050	1

### HÉLICE HÉLICOÏDALE ULTRA



Pour matériaux épais à forte viscosité : enduits et mortiers de finition, colles à carrelage, plâtre, chaux, enduits au ciment, ragréage béton.

	Quantité à mélanger kg	Vitesse en charge conseillée en tr/mn	Puissance minimal de la perceuse en W	Longueur totale en mm	Ø base mm	Ref.	
4 - 10	5 - 10	400/500	700	500	90	881030	1

### HÉLICE CONIQUE SPEED



Pour produits liquides, à faible viscosité : peintures, colles, enduits chimiques.

	Quantité à mélanger kg	Vitesse en charge conseillée en tr/mn	Puissance minimal de la perceuse en W	Longueur totale en mm	Ø base mm	Ref.	
80	5 - 10	500/700	500	400	80	881010	1
120	20 - 30	400/600	700	590	120	881020	1

### FORME FOUET MIX 130

Pour colles, liquides d'isolation et d'étanchéité, pour matières pulvérulentes.



	Quantité à mélanger kg	Vitesse en charge conseillée en tr/mn	Puissance minimal de la perceuse en W	Longueur totale en mm	Ø base mm	Ref.	
10 - 20	400/800	450	600	130	881060	1	

### HÉLICE PLASTIQUE MINI 60

Pour peintures.



	Quantité à mélanger kg	Vitesse en charge conseillée en tr/mn	Puissance minimal de la perceuse en W	Longueur totale en mm	Ø base mm	Ref.	
0 - 5	800/1000	300	350	60	881000	1	

### HÉLICE PLASTIQUE KR 85S

Pour peintures murales, vernis et peintures émulsions.



	Quantité à mélanger kg	Vitesse en charge conseillée en tr/mn	Puissance minimal de la perceuse en W	Longueur totale en mm	Ø base mm	Ref.	
0 - 5	800/1000	300	400	85	881070	1	



16



62



96



120



126



156



188



224



248



254



300



316



340



390



462



488



509

# BACS - BÂCHES

## BAC BOND EN POLYÉTHYLÈNE NOIR 20 LITRES AVEC ANSE

Fond et rebord renforcés.  
Graduation en litres.



Capacité L	Ø anse mm	Ø intérieur cm	Hauteur cm	kg	Ref.	📦
20	7	34	27	1,20	345020	1

## BAC ROND EN POLYÉTHYLÈNE NOIR 40 LITRES

Fond et rebord renforcés.



	Capacité L	Ø anse mm	Ø intérieur cm	Hauteur cm	kg	Ref.	📦
Avec anse	40	9	47,5	31	2,60	345050	1
Sans anse	40	-	47,5	31	1,55	345040	1

## GRAND BAC ROND EN POLYÉTHYLÈNE NOIR

Fond et rebord renforcés.



Capacité L	Ø intérieur cm	Hauteur cm	kg	Ref.	📦
90	59	36	2,65	345090	1
120	65	41	5,60	345120	1

## BAC RECTANGULAIRE POLYÉTHYLÈNE NOIR 65 LITRES

Fond et rebord renforcés.  
Avec poignées intégrées.  
Graduation en litres.



Capacité L	Dim. intérieures cm	Hauteur cm	kg	Ref.	📦
65	65 x 35	29	2,10	345070	1

## BÂCHE

### + LES PLUS

- Angles renforcés
- Oeillets plastique tous les 50 cm pour une fixation facile et rapide.

### UTILISATION

- Pour la protection de surfaces ou d'objets.

### CARACTÉRISTIQUES

- 145 gr/m<sup>2</sup> environ
- En polyéthylène armé, enduit sur 2 faces
- 1 face bleue, 1 face verte



## BÂCHE POLYÉTHYLÈNE

Protection. 145 g/m<sup>2</sup> environ. En polyéthylène armé, enduit sur 2 faces.  
Angles renforcés. Oeillets plastique tous les 50 cm.

Largeur m	Longueur m	Surface m <sup>2</sup>	Ancienne Ref. Mob	Ref.	📦
2	3	6 environ	6425030201	841220	1
4	5	20 environ	6425040501	841240	1
5	8	40 environ	6425050801	841250	1
6	10	60 environ	6425061001	841260	1
8	12	96 environ	6425081201	841280	1

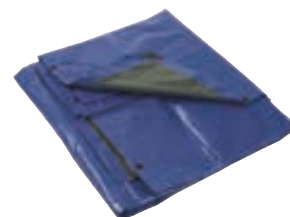

## FILET DE PROTECTION MODÈLE SUPÉRIEUR

Indémaillable avec double trame, en polyéthylène haute densité 105 g/m<sup>2</sup> environ. Pour échafaudages. Vert. Traité anti-UV. Avec bandes d'oeillets polyester tous les mètres dans la largeur.



Longueur m	Largeur m	Surface m <sup>2</sup>	Ref.	📦
20	3	60 environ	843200	1

## FILET DE PROTECTION MODÈLE ÉCONOMIQUE

Filet de protection pour échafaudages en polyéthylène. 50 g/m<sup>2</sup> environ. Indémaillable. Traité anti-UV. Lisières renforcées pour fixation avec oeillets tissés.



Longueur m	Largeur m	Surface m <sup>2</sup>	Ref.	📦
20	3	60	844240	1





## BROSSE À BOUGIE

3 rangs - fil en acier  
laitonné



	L cm	g	Ref.	☐
acier dur	20	70	863240	1
acier souple	20	70	863250	1

## BROSSE MÉTALLIQUE À MANCHE

4 rangs - fil en acier



	L cm	g	Ref.	☐
acier laitoné dur	30	175	863220	1
acier laitoné souple	30	175	863230	1
acier rond trempé noir	30	180	863270	1

## BROSSE-RABOT

4 rangs - fil en acier  
laitonné dur - manche  
plastique - permet  
un brossage plus  
puissant qu'une brosse  
traditionnelle



	L cm	Ref.	☐
acier laitoné dur	25	863260	1

## BROSSE VIOLON

5 rangs - fil en acier



	L cm	g	Ref.	☐	Ancienne Ref. Mob	☐
acier laitoné dur	20	190	863200	1	6410001001	1
acier laitoné souple	20	190	863210	1		
acier rond trempé noir	20	190	863180	1		

## BROSSE CONVEXE

Fil en acier laitoné



	g	Ref.	☐
acier dur	120	863310	1

## BROSSE À DESSABLER EN NYLON



Ref.	☐
863320	1

## BROSSE VIOLON CHIENDENT



Ref.	☐
863190	1

## BROSSE CRINIÈRE POLYPROPYLÈNE MONTURE BOIS



Ref.	☐
863350	1

## BALAI LAVE-PONT CHIENDENT

Avec douille plastique fixée



Ø douille mm	Ref.	☐	☐
24	863110	161240 + 863160	1

## BALAI COCO ZÉBRÉ

Avec douille. Composé de  
fibre de coco et de fibres  
polypropylène. 2 couleurs :  
marron et vert.



L cm	Ø douille mm	Ref.	☐	☐
29	24	863130	161240 + 863160	1

## BALAI COCO 29 CM

Avec douille plastique  
fixée.



L cm	Ø douille mm	Ref.	☐	☐
29	24	863100	161240 + 863160	1

## BALAI MICKEY PIASSAVA 3 RANGS

Avec douille plastique  
fixée.



L cm	Ø douille mm	Ref.	☐	☐
25	24	863120	161240 + 863160	1



16



62



96



120



126



156



188



224



248



254



300



316



340



390



462



488



511



## BALAI DE CANTONNIER CRYNOVIL

### UTILISATION

- Pour balayer des surfaces rugueuses et dures, les sols difficiles (terre battue, caniveaux...)
- Intérieur et extérieur.



### CARACTÉRISTIQUES

- Brosse robuste et rigide en fibres synthétiques rouges (crynovil), résistante à l'humidité
- Monture en bois.
- Avec douille acier peint, boulonnée, avec ergots anti-retour du manche, diamètre 28 mm.
- Modèle à douille avec tire-fonds.



## BALAI DE CANTONNIER CRYNOVIL ROUGE

Modèle à douille avec tire-fonds.



L cm	Ø douille mm	Ref.		
32	28	863000	161260	1

## BALAI DE CANTONNIER PIASSAVA



L cm	Ø douille mm	Ref.		
32	28	863020	161260	1

## BALAI DE CANTONNIER CRYNOVIL BLANC

Avec douille acier peint, boulonnée, avec ergots anti-retour du manche



L cm	Ø douille mm	Ref.		
40	28	863050	161260	1
32	28	863040	161260	1

## BALAI DE PISTE CRYNOVIL



L cm	Ø douille mm	Ref.		
60	28	863090	161260	1

## BALAI DE CANTONNIER + LAME RACLOIR

Pour application TP. Garniture en crynovil rouge. Lame acier fixée sur la monture bois. Douille acier Ø 28 mm.

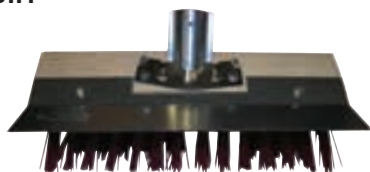

L cm	Ø douille mm	Ref.		
32	28	863030	161260	1

## BALAI DE PISTE COCO



L cm	Ø douille mm	Ref.		
60	28	863070	161260	1
100	28	863080	161260	1



## BALAI CANTOPRO

### UTILISATION

- Balai de chantier en largeur 32 cm et balai de piste en largeur 55 cm
- La forme permet de faire converger les déchets plus facilement, ce qui permet de gagner en temps de passage.



### CARACTÉRISTIQUES FIBRES

- Matière : PVC
- Orientation multiple pour concentrer les déchets
- Diamètre de fibre 10/10ème

### MONTURE

- Matière : polypropylène (PP) grande résistance
- Douille intégrée dans la monture, diamètre 28 mm
- Angle de 35°



## BALAI DE CANTONNIER CANTOPRO

Douille intégrée.



L m	Ø douille mm	H mm	Ref.		
32	28	166	863400	161260	1

## MANCHE À BALAIS Ø 28 MM

Pour tous les balais de cantonnier et les balais de piste.  
Même manche que raclette de carreleur bois de 70 cm avec douille.



L m	Ø mm	Ref.	
1,4	28	161260	12

## MANCHE À BALAIS Ø 24 MM

Pour les balais à Ø douille 24 mm.  
S'utilise avec l'adaptateur 863160.  
Même manche que raclette de carreleur bois de 44 et raclettes métal de 44, 55 et 75 cm.



L m	Ø mm	Ref.	
1,2	24	161240	12

## BALAI DE PISTE CANTOPRO

Douille intégrée.



L m	Ø douille mm	H mm	Ref.		
55	28	166	863410	161260	12

## MANCHE À BALAIS Ø 24 MM AVEC ADAPTATEUR

Pour le balai coco et le balai Mickey.  
Adaptateur PVC vissant intégré.



L m	Ø mm	Ref.	
1,20	24	161241	12

## ADAPTATEUR PVC VISSANT

S'utilise sur le manche 161240.



Ref.	
863160	1



16



62



96



120



126



156



188



224



248



254



300



316



340



390



462



488



513

# BROSSERIE, BALAIS, POUBELLES

## BALAYETTE DE CARRELEUR COCO 3 RANGS

Toutes les surfaces (intérieures et extérieures). Robustes et imputrescibles, les fibres coco résistent à l'écrasement.



L cm	Ref.	
45	863280	1

## PELLE À POUSSIÈRE



L cm	g	Ref.	
22	300	863170	1

## BALAI PAILLE DE RIZ 5 FILS



L manche mm	Ref.	
88	863140	10

## PINCEAU MOUILLEUR COCO

Virole acier



Ø mm	Ref.	
60	863300	1

## BALAI À DESSABLER AVEC PASSAGE D'EAU

Brosse composée de plus de 5000 fibres mi-dures. Pour un nettoyage intensif des banches de coffrage, des murs, des terrasses... Bonne résistance aux produits chimiques.



Fin de vie.

L cm	Ref.		
25	863330	863340	1

## MANCHE ALU À PASSAGE D'EAU POUR BALAI À DESSABLER

Manche télescopique en aluminium livré avec un raccord pour brosse et un raccord pour tuyau d'arrosage. Equipé d'un clapet d'arrêt du passage de l'eau. Bonne tenue en main grâce à une gaine en mousse.



Fin de vie.

L cm	Ø mm	Ref.	
2 x 90	25	863340	1

## POUBELLE 80 LITRES AVEC POIGNÉES

En polyéthylène.



	Capacité L	kg	Ref.	
Corps de poubelle.	80	2,80	345170	1
Couvercle seul		0,15	345180	1

## POUBELLE 50 LITRES AVEC 2 POIGNÉES

En polyéthylène.



Capacité L	kg	Ref.	
50	2,40	345190	1

## GOULOTTE À GRAVATS

### + LES PLUS GOULOTTE

- Polyéthylène haute densité
- Bonne résistance aux chocs
- Possibilité d'adapter un treuil manuel sur le support métallique
- Système d'accrochage renforcé
- Livrée avec chaînes et mousquetons.



348000

### + LES PLUS

#### TREUIL MANUEL

- Mise en place des goulottes aisée et en toute sécurité
- Dispositif anti-retour avec freinage automatique
- Conforme à la norme **CE**
- Résistance de l'ensemble support + treuil : 350 kg.



348060



348010



### ENTONNOIR DE RÉCEPTION

Longueur : 95 cm, largeur : 52 cm, hauteur : 62 cm (hauteur utile 52 cm).  
Poids : 9 kg.  
Orifice rond : Ø : 44 cm.  
Orifice rectangulaire : 43 cm x 38 cm.



L cm	l cm	H cm	H utile cm	kg	Ref.	cube
95	52	62	52	9	348000	1

### GOULOTTE AVEC CHAÎNE ET MOUSQUETONS

Poids : 9 kg. Ø supérieur : 52 cm.  
Ø inférieur : 39 cm.  
Hauteur : 1,08 m (hauteur utile 96 cm).  
Maillon : 44 mm et Ø 5 mm.



Ø supérieur cm	Ø inférieur cm	H cm	H utile cm	kg	Ref.	cube
52	39	108	96	9	348010	1

### RALENTISSEUR À GRAVATS

Utilisé pour diminuer la vitesse d'évacuation dans les goulottes à gravats. Les ralentisseurs doivent être positionnés dans le tube de départ (tête de colonne) puis un ralentisseur tous les 3 ou 4 tubes en fonction du résultat souhaité. Le plus : moins de bruit et de poussière.



Ref.	cube
348030	1

### SUPPORT MÉTALLIQUE

Pour entonnoir et goulottes.

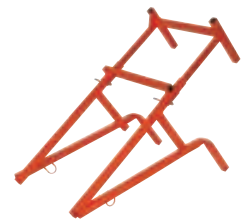

kg	Ref.	cube
16	348020	1

### TREUIL MANUEL ADAPTABLE SUR SUPPORT MÉTALLIQUE

Longueur câble : 33 m (30 goulottes).  
Conforme à la norme **CE**



kg	Ref.	cube
15	348060	1

### SUPPORT MÉTALLIQUE AVEC TREUIL

Conforme à la norme **CE**



Ref.	cube
348040	1



16



62



96



120



126



156



188



224



248



254



300



316



340



390



462



488



515

## GRILLAGE AVERTISSEUR

### CARACTÉRISTIQUES

- Conforme à la norme NF
- En rouleau de 100 m, largeur 30 cm.

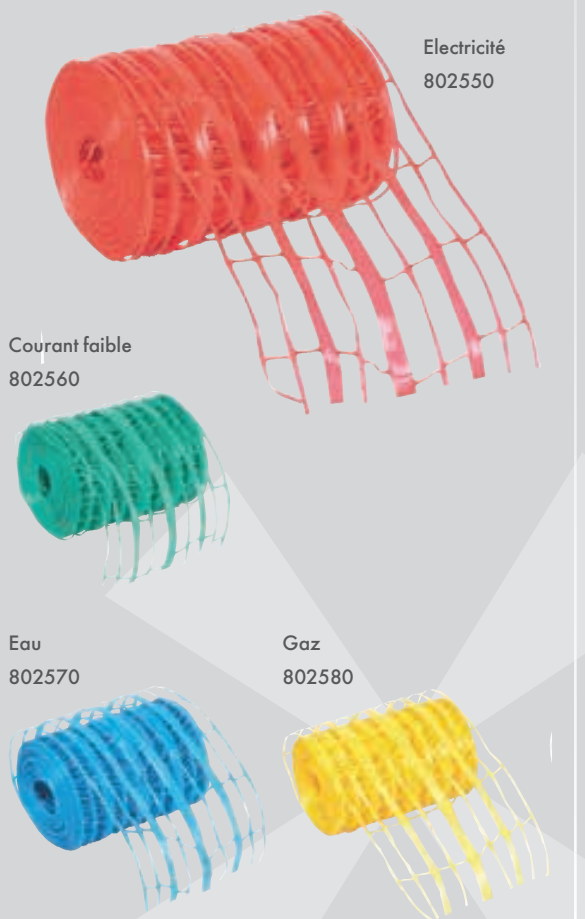

### GRILLAGE AVERTISSEUR

Conforme à la norme NF.

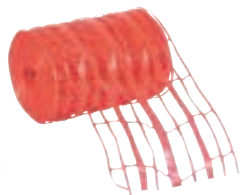

Couleur	L m	Largeur cm	Ref.	📦
Rouge - Electricité	100	30	802550	1
Vert - Courant faible	100	30	802560	1
Bleu - Eau	100	30	802570	1
Jaune - Gaz	100	30	802580	1

### BARRIÈRE DE CHANTIER

Polypropylène. Traité anti-UV. Orange.  
Maille : 100 x 40 mm environ. Poids net : 150 g/m<sup>2</sup> environ. En rouleau.



L m	Largeur m	📦 kg	Ref.	📦
50	1,00	7,5 environ	802610	1
50	1,20	9 environ	802620	1

### BARRIÈRE DE CHANTIER ECO

Poids : Environ 80 g/m<sup>2</sup>. Matière : PE, extrudé et mono-orienté.  
Maille de 75 x 22 mm. Résistance mécanique dans le sens longitudinal : 2,5 kN/m. En rouleau.



L m	Largeur m	📦 kg	Ref.	📦
50	1	4	802600	1

### FICHE DE CHANTIER - PIQUET POUR BARRIÈRE



L m	Ø mm	Ref.	📦
1	14	802630	25

### SAC À GRAVATS NON RÉUTILISABLE

Polypropylène tissé.  
Avec goulotte de vidange Ø 60 cm, longueur 50 cm.  
4 anses de levage de 30 cm.  
Coefficient : 5.1.



Dim. cm	Capacité kg	Ref.	📦
91 x 91 x 125	1500	348100	1

### SAC À GRAVATS NON RÉUTILISABLE, FOND PLAT

Polypropylène tissé.  
Fond plat. 4 anses de levage de 30 cm.  
Coefficient : 5.1.



Dim. cm	Capacité kg	Ref.	📦
100 x 100 x 100	1500	348110	1

### SAC À GRAVATS NON RÉUTILISABLE

Polypropylène tissé blanc.



Dim. cm	Ref.	📦
60 x 105	348070	50

### SAC À GRAVATS RÉUTILISABLE

Charge de rupture supérieure à 6 tonnes. Conforme à EN 1898 - Coefficient : 6.1 (réutilisable).  
Encombrement très faible.



Dim. cm	Capacité kg	Ref.	📦
90 x 90 x 90	1500	348090	1



## CÔNE DE SIGNALISATION

### UTILISATION

- Pour délimiter des zones de balisage, indiquer les endroits dangereux, obstacles, orientations du trafic, etc.

### CARACTÉRISTIQUES

- Réalisés en PVC orange, ces cônes sont souples et résistent à de gros écarts de températures (+40° à -30°C) sans perte de résistance mécanique.



Hauteur 32 cm  
801040

Hauteur 50 cm  
801050



## CÔNE DE SIGNALISATION

En PVC orange.



Hauteur cm	kg	Nombre de bandes	Ref.	☐
32	0,52	1	801040	20
50	1,20	2	801050	10
75	4,03	2	801060	5

## CHAÎNE ROUGE ET BLANCHE N°8

Maillon Ø 8 x 49 mm x 29 mm.  
Sac de 25 m.



Longueur m	Ref.	☐
25	801070	1

## FARDIER

Forme cylindrique en plastique. Avec bande fluorescente rouge.



Ref.	☐
801600	4

## RUBAN DE SIGNALISATION, EN POLYÉTHYLENE

Chevrons rouge et blanc.



Largeur cm	Longueur m	Ref.	☐
5	100	801000	12

## RUBAN DE SIGNALISATION ULTRA RÉSISTANT

Chevrons rouge et blanc.



Largeur cm	Longueur m	Ref.	☐
5	100	801010	12

## PIQUET DE CHANTIER 1 FACE

Type K5B. Adhésif rétro réfléchissant pour une bonne visibilité le jour comme la nuit. Tôle en acier galvanisé assemblée avec le piquet par deux rivets haute résistance. Epaisseur : 2,5 mm. Pointe haute résistance et biseautée pour une implantation rapide.



Nombre de faces	Hauteur m	Ref.	☐
1	1,10	801100	10

## PIQUET DE CHANTIER 2 FACES

Type K5B. Adhésif rétro réfléchissant pour une bonne visibilité le jour comme la nuit. Tôle en acier galvanisé assemblée avec le piquet par deux rivets haute résistance. Epaisseur : 2,5 mm. Pointe en haute résistance et biseautée pour une implantation rapide.



Nombre de faces	Hauteur m	Ref.	☐
2	1,10	801110	10



16



62



96



120



126



156



188



224



248



254



300



316



340



390



462



488



517

## SAC DE LESTAGE

- Permet de lester sur les chantiers en particulier les panneaux de signalisation
- Contient jusqu'à 30 kg de sable
- Polypropylène (PP) tissé, non traité contre les UV
- Avec lien de fermeture



Dim cm	Ref.	
35 x 60	348200	50

## PANNEAU CHANTIER INTERDIT AU PUBLIC



Longueur cm	Largeur cm	Ref.	
28	20	802000	1

## PANNEAU ATTENTION - SORTIE DE CAMIONS



Dimensions cm	Ref.	
28 x 20	802150	1

## PANNEAU DÉFENSE DE DEPOSER DES ORDURES



Dimensions cm	Ref.	
28 x 20	802010	1

## PANNEAU DÉFENSE DE STATIONNER. SORTIE DE VOITURES



Ø cm	Ref.	
28	802070	1

## PANNEAU DÉFENSE DE FUMER

Avec mention loi et n° de Décret.



Ø cm	Ref.	
28	802030	1

## PANNEAU EXTINCTEUR



Ø cm	Ref.	
28	801959	1

## PANNEAU ROULEZ AU PAS



Ø cm	Ref.	
28	802220	1

## PANNEAU PIÉTONS PASSEZ EN FACE



Ø cm	Ref.	
28	802210	1

## PANNEAU DANGER



L côté triangle cm	Ref.	
28	801990	1

## PANNEAU PASSAGE DANGEREUX



L côté triangle cm	Ref.	
28	801980	1

## PANNEAU SENS INTERDIT



Ø cm	Ref.	
28	802240	1





## PANNEAU PÊCHE INTERDITE



Ø cm	Ref.	📦
28	802120	1

## PANNEAU DANGER - ENTREE INTERDITE



Ø cm	Ref.	📦
28	802180	1

## PANNEAU PROPRIÉTÉ PRIVÉE. DÉFENSE D'ENTRER



Ø cm	Ref.	📦
28	802020	1

## PANNEAU CHASSE GARDÉE



Dimensions cm	Ref.	📦
28 x 20	802080	1

## PANNEAU STATIONNEMENT INTERDIT



Ø cm	Ref.	📦
28	802190	1

## PANNEAU STOP



Ø cm	Ref.	📦
28	802230	1

## PANNEAU PORT DU CASQUE OBLIGATOIRE



Dimensions cm	Ref.	📦
28 x 20	802050	1

## PANNEAU ATTENTION AU CHIEN



Dimensions cm	Ref.	📦
28 x 20	802170	1

## PANNEAU CHASSE INTERDITE



Ø cm	Ref.	📦
28	802090	1

## PANNEAU DANGER TRAVAUX



L côté triangle cm	Ref.	📦
28	801970	1

## PANNEAU 4 EN 1

Conforme à la norme NF X08-003. Il précise l'accès interdit au public, la protection obligatoire de la tête, l'interdiction de stationner et prévient du danger. Sérigraphie 4 couleurs sur polypropylène alvéolaire blanc.



Longueur mm	Hauteur mm	Ref.	📦
800	400	802350	5

## PANNEAUX PERMIS DE CONSTRUIRE 80 X 80

En Akylux 450 g/m<sup>2</sup>.



Dimensions cm	Ref.	📦
80 x 80	802250	10

## PANNEAU PERMIS DE CONSTRUIRE 80 X 120

En Akylux 450 g/m<sup>2</sup>.



Dimensions cm	Ref.	📦
80 x 120	802260	10



16



62



96



120



126



156



188



224



248



254



300



316



340



390



462



488



519



# INDEX ALPHABÉTIQUE

<b>A_</b>			
ABRASIF.....	422	BOUCARDE TERRASSEMENT.....	379
ACCESSOIRE DE LEVAGE.....	494	BOUVEROLLE À MAIN.....	288
ACCESSOIRES DE PEINTRE.....	434	BOX 31 - COFFRET VISSAGE 1/4.....	70
ACCESSOIRES POUR ÉTAUX.....	327	BOX DE CLÉS MIXTES À CLIQUET.....	105
ACRYLAQUE GAMME STANDARD.....	439	BOX EXTRACTEURS DE VIS CASSÉES.....	337
ADAPTATEUR 1" A 3/4".....	93	BOX EXTRACTION M4-M20.....	337
ADAPTATEUR DÉBOUCHANT.....	88	BOX LIMITEURS DE COUPLE.....	125
ADAPTATEUR IMPACT.....	95	BOX MAINTENANCE.....	161
ADAPTATEUR PVC VISSANT.....	513	BOX MAINTENANCE ÉLECTRIQUE.....	165
ADAPTATEURS 3/4" A 1/2".....	91	BOX SPIN POWER 1/4".....	76
AGITATEUR ÉLECTRIQUE TECMIX.....	508	BOX TOURNEVIS DYNAMOMÉTRIQUE.....	124
AGITATEURS - MÉLANGEURS.....	508	BRISSARD DE SÉCURITÉ.....	504
ANTIGOUTTE RAYÉ JAUNE.....	438	BRIQUE CARBORUNDUM.....	370
APPAREIL À BATTRE LES COLLETS.....	319	BROCHE DE CHAUDRONNIER.....	288
APPAREIL À DÉCOFFRER.....	360	BROCHE DE MAÇON.....	290
ARCEAU ANTI-BRUIT.....	502	BROCHE DE MONTEUR.....	297
ARRACHE CLOU NAILEXPRESS.....	297	BROCHE D'ÉLECTRICIEN.....	292
ARRACHE-CLOUS "Z".....	297	BROSSE À BADIGEON.....	435
AUGE.....	352	BROSSE À BOUGIE.....	511
AUGE À FOND CYLINDRIQUE 210 L.....	430	BROSSE À DESSABLER EN NYLON.....	511
AUGE À PLÂTRE MONOBLOC.....	430	BROSSE À ÉPOUSSETER.....	433
AUGE CABAS.....	354	BROSSE CONVEXE.....	511
AUGE DE MAÇON CAOUTCHOUC.....	353	BROSSE CRINIÈRE.....	511
AUGE DE MAÇON PROCHOK®.....	353	BROSSE DE COLLEUR STANDARD.....	433
AUGE MAÇON PLASTIQUE.....	352	BROSSE MÉTALLIQUE.....	511
AUGES PLÂTRIER.....	430	BROSSE PEINTURE.....	436
AUGETTE À RACCORDS.....	441	BROSSE VIOLON.....	511
AUGMENTATEUR CARRÉ 1/4".....	67	BROSSE-RABOT.....	511
AUGMENTATEUR CARRÉ 3/8".....	77	BRUCELLE ARRONDIE.....	167
		BURIN DE CARRELEUR.....	292
		BURIN DE MÉCANICIEN.....	286
		BURIN EXTRA PLAT DE CARROSSIER.....	287
		BURIN LATÉRAL.....	287
<b>B_</b>		<b>C_</b>	
BAC À CIMENT.....	356	CADENAS.....	30
BAC À ENDUIT PLASTIQUE.....	420	CALE À BÉTON.....	348
BAC PLASTIQUE POUR ROULEAUX.....	441	CALE À PONCER.....	422
BAC RECTANGULAIRE NOIR 65L.....	510	CALE-PLAQUE À LEVIER.....	418
BAC ROND NOIR.....	510	CALES CRANTÉES.....	388
BÂCHE POLYÉTHYLÈNE.....	510	CALES D'ÉPAISSEUR.....	388
BACS À CIMENT.....	356	CALES POUR POSE-LAME.....	388
BALADEUSE PVC AVEC PINCE.....	504	CALIBRE DE SOUDEUR.....	231
BALAI À DÉBULLER.....	383	CAMION PLASTIQUE.....	441
BALAI CANTOPRO.....	513	CARDAN UNIVERSEL 1".....	93
BALAI COCO.....	511	CARDAN UNIVERSEL 1/2".....	82
BALAI DE CANTONNIER.....	512	CARDAN UNIVERSEL 1/4".....	67
BALAI DE CANTONNIER CANTOPRO.....	513	CARDAN UNIVERSEL 3/4".....	91
BALAI DE CANTONNIER RACLOIR.....	512	CARDAN UNIVERSEL 3/8".....	77
BALAI DE PISTE.....	512	CARDAN UNIVERSEL IMPACT.....	94
BALAYETTE.....	514	CARDE A LIME.....	219
BANDE DE RÉPARATION.....	434	CARGO MULTI.....	47
BANJO DISTRIBUTEUR DE BANDE.....	419	CARRÉ 1".....	92
BARRE À DÉBULLER.....	381	CARRÉ 1/2".....	78
BARRE À MINE.....	299	CARRÉ 1/4".....	64
BARRIÈRE DE CHANTIER.....	516	CARRÉ 1/4" 1/2".....	86
BASIC PLUS.....	444	CARRÉ 3/4".....	90
BATTE À PLANER.....	264	CARRÉ 3/8".....	76
BATTE CAOUTCHOUC.....	453	CASQUE DE CHANTIER.....	503
BATTE SAMBA.....	453	CEINTURE PORTE-OUTILS.....	41
BÉDANE DE MÉCANICIEN.....	287	CHABLOT.....	247
BÉDANE DE MENUISIER.....	222	CHAÎNE ROUGE ET BLANCHE.....	517
BIBER BAR.....	297	CHARIOT PORTE SEAU.....	442
BIG MUTT.....	345	CHARIOT PORTE-PLAQUES.....	404
BLOC DE CENTRAGE.....	251	CHASSE À PIERRE.....	292
BLOCK'UP.....	235	CHASSE DYNACHOC.....	266
BOBINOT DE FIL.....	348	CHASSE-AXES.....	288
BOÎTE À COUPE.....	194	CHASSE-GOUPILLES.....	288
BOÎTE À COUPE FORME V.....	435	CHASSE-POINTES.....	287
BOÎTE À COUPE PLASTIQUE.....	435	CHEMIN DE FER DENTÉ.....	384
BOÎTE À OUTILS GARNIE.....	54	CHEVILLE.....	293
BOÎTE À OUTILS METAL.....	36	CHIFFRES À FRAPPER.....	231
BOÎTE D'EMBOUTS.....	154	CISAILLE À TÔLE.....	410
BOÎTES À OUTILS.....	35	CISAILLE AVIATION.....	187
BOÎTES À OUTILS TEXTILE.....	37	CISAILLE GRIGNOTEUSE.....	410
BOÎTIER À POIGNÉE.....	237	CISAILLE PASSE-TÔLE.....	186
BOÎTIER MESURE.....	237		
BOUCARDE À PLAQUETTES.....	280		
		CISAILLE PLAQUISTE.....	377
		CISAILLES À DÉMULTIPLICATION.....	187
		CISAILLES CLASSIQUES.....	186
		CISEAU À BRIQUE.....	292
		CISEAU DE CHARPENTIER.....	292
		CISEAU DE MAÇON.....	291
		CISEAU DE SCULPTEUR.....	221
		CISEAU D'ÉLECTRICIEN.....	292
		CISEAUX D'ATELIER.....	199
		CISEAUX D'ÉLECTRICIEN.....	200
		CLÉ À BÉQUILLE.....	119
		CLÉ À BOUGIE.....	119
		CLÉ À CARDAN.....	119
		CLÉ À CHAÎNE.....	319
		CLÉ À SANGLE.....	319
		CLÉ DE MONTAGE ÉTAGÉE.....	322
		CLÉ DYNAMOMÉTRIQUE.....	122
		CLÉ POUR ARMOIRE ÉLECTRIQUE.....	184
		CLÉS À CLIQUET.....	105
		CLÉS À CLIQUET 4X4.....	109
		CLÉS À CLIQUET ARTICULÉES.....	107
		CLÉS À CRÉMAILLÈRE.....	117
		CLÉS À FOURCHES.....	111
		CLÉS À FRAPPER.....	113
		CLÉS À MOLETTE.....	117
		CLÉS À PIPE.....	102
		CLÉS À TUYAUTER.....	115
		CLÉS CONTRECOURBÉS.....	114
		CLÉS DE MONTEUR.....	119
		CLÉS DEMI-LUNE.....	115
		CLÉS EMMANCHÉES EN T.....	142
		CLÉS EN CROIX.....	119
		CLÉS MÂLES.....	140
		CLÉS MÂLES CRV.....	140
		CLÉS MÂLES PROTANIUM.....	139
		CLÉS MIXTES.....	99
		CLÉS MIXTES À CLIQUET.....	105
		CLÉS MIXTES À CLIQUET COURTES.....	106
		CLÉS MIXTES LONGUES.....	99
		CLÉS POLYGONALES.....	114
		CLÉS SERRE-TUBES.....	319
		CLÉS STILLSON.....	319
		CLÉS SUÉDOISES.....	319
		CLÉS U.S.....	319
		CLICK'N HOLD RALLONGE 1/2".....	82
		CLICK'N HOLD RALLONGE 1/4".....	67
		CLIQUET / DOUILLES TRAVERSANTS.....	88
		CLIQUET 1".....	92
		CLIQUET 1/2".....	78
		CLIQUET 1/2" FEMELLE.....	78
		CLIQUET 1/4".....	64
		CLIQUET 3/4".....	90
		CLIQUET À TÊTE TRAVERSANTE.....	88
		CLIQUET MEDIUM 3/8".....	76
		CLIQUET MICRO 1/4".....	64
		CLIQUET PORTE-DOUILLE.....	65
		CLIQUET TÊTE ROTATIVE.....	65
		CLOSED BAG FRESH LINE.....	38
		COFFRE DE CHANTIER.....	34
		COFFRET 5 CISEAUX DE SCULPTEUR.....	222
		COFFRET À RIVETER.....	182
		COFFRET BOX 1/2".....	84
		COFFRET BOX 1/4".....	73
		COFFRET BOX 1/4"-1/2".....	86
		COFFRET DE CHASSE-GOUPILLES.....	288
		COFFRET DE CHASSE-GOUPILLES.....	288
		COFFRET DE CLÉS À CLIQUET.....	105
		COFFRET DE CLÉS À CLIQUET.....	110
		COFFRET DE CLÉS À CLIQUET 4X4.....	109
		COFFRET DE CLÉS MIXTES.....	100
		COFFRET DE DOUILLES TRAVERS.....	89
		COFFRET DE SCIES TRÉPANS.....	447
		COFFRET DE TÔLIER.....	264
		COFFRET DÉCOUPE-JOINTS.....	250
		COFFRET DÉCOUPOIRS.....	250
		COFFRET D'EMBOUTS DE VISSAGE.....	155
		COFFRET EMBOUTS PRÉCISION.....	153
		COFFRET FUSION BOX CARGO.....	47
		COFFRET MAINTENANCE 11 EN 1.....	72
		COFFRET MÉTALLIQUE 1/4"-1/2".....	86
		COFFRET MÉTALLIQUE 1".....	93
		COFFRET MÉTALLIQUE 1/2".....	83
		COFFRET MÉTALLIQUE 3/4".....	92
		COFFRET PLASTIQUE 1/2".....	83
		COFFRET PLASTIQUE 1/4".....	74
		COFFRET XS BOX.....	71
		COIN À BOIS.....	282
		COINS À BÂTIR.....	359
		COINS CYLINDRIQUES.....	283
		COINS DE CARRELEUR.....	454
		COINS POUR MARTEAUX.....	283
		COLORANTS.....	372
		CORBANAISON POLYPROPYLENE.....	504
		COMPARATEUR À LEVIER.....	228
		COMPARATEUR MÉCANIQUE.....	228
		COMPAS À CHARNIÈRE.....	230
		COMPAS À POINTE.....	230
		COMPAS PORTE-CRAYONS.....	230
		CÔNE DE SIGNALISATION.....	517
		CONNECTEUR TALOCHE-GRATTON.....	369
		CORDAGE BÂTIMENT.....	247
		CORDAMAIN.....	246
		CORDE À POULIE.....	247
		CORDEAU COTON.....	247
		CORDEAU DE CHARPENTIER.....	245
		CORDEAU DE RECHANGE.....	246
		CORDEAU POLYAMIDE.....	247
		CORDEAU-TRACEUR.....	245
		CORDO.....	246
		COSMOS-LINE.....	245
		COULISSE POUR TRÉPIED.....	432
		COUPE POLYSTYRÈNE ÉLECTRIQUE.....	194
		COUPE TUBE TÉLESCOPIQUE CUIVRE.....	320
		COUPE-BOULONS BRAS FORGÉS.....	180
		COUPE-BOULONS CLASSIQUES.....	178
		COUPE-BOULONS FORCE.....	179
		COUPE-BOULONS HAUTE QUALITÉ.....	181
		COUPE-CÂBLES.....	184
		COUPE-CARREAUX.....	444
		COUPE-TOUT.....	185
		COUPE-TUBE ACIER.....	320
		COUPE-TUBE CUIVRE.....	320
		COUPE-TUBE PVC.....	321
		COUPE-TUBE TÉLESCOPIQUE INOX.....	320
		COUPEAU À ENDUIRE.....	477
		COUPEAU À MAROUFLER.....	433
		COUPEAU À MASTIQUER.....	479
		COUPEAU À PLÂTRE.....	431
		COUPEAU À REBOUCHER.....	479
		COUPEAU À RONDELLE.....	251
		COUPEAU À SERRER LES BANDES.....	421
		COUPEAU AMÉRICAIN.....	478
		COUPEAU BRUT DE DECOFFRAGE.....	475
		COUPEAU DE PEINTRE.....	479
		COUPEAU D'ÉLECTRICIEN.....	201
		COUPEAU FORME TRAPÈZE.....	434
		COUPEAU MULTI-USAGES.....	479
		COUPEAU POUR ISOLATION.....	377
		COUPEAU TAJIMA®.....	196
		COUPEAU TRIANGULAIRE.....	434
		COUPEAU UNIVERSEL.....	197
		CRAIES INDUSTRIELLES.....	243
		CRAYON.....	243
		CROISILLON.....	454
		CROSSE SUPPORT DE RÈGLE.....	409
		CUILLÈRE.....	265
		CUTTER.....	196
		CUTTER À LAME AUTO-RÉTRACTABLE.....	197
		CUTTER À VERROUILLAGE VIS 25MM.....	198
		CUTTER TAJIMA®.....	196
		CUTTERS MOB.....	197



CUTTERS MONDELIN ..... 197  
 CUTTERS TAJIMA ..... 196

## D

DAME DE MAÇON ..... 347  
 DÉBOUCHEUR DE BUSES ..... 371  
 DÉCAPEUR THERMIQUE ..... 507  
 DÉCINTROIR ..... 279  
 DECOJOINT® ..... 457  
 DECOUPE DES MOULURES ..... 435  
 DÉROULEUR DE BANDES ..... 421  
 DÉROULEUR DE FILM PARE-VAPEUR ..... 402  
 DIVISEUR DE TIROIR ..... 30  
 DOIGT MAGNÉTIQUE ..... 333  
 DOUBLE VENTOUSE ..... 453  
 DOUILLE 12 PANS 1" ..... 93  
 DOUILLE 12 PANS 1/2" ..... 80  
 DOUILLE 12 PANS 1/4" ..... 66  
 DOUILLE 12 PANS 3/4" ..... 90  
 DOUILLE 12 PANS 3/8" ..... 76  
 DOUILLE 6 PANS 1" ..... 93  
 DOUILLE 6 PANS 1/2" ..... 79  
 DOUILLE 6 PANS 1/4" ..... 66  
 DOUILLE 6 PANS 3/4" ..... 90  
 DOUILLE 6 PANS 3/8" ..... 76  
 DOUILLE À BOUGIES 1/2" ..... 80  
 DOUILLE IMPACT 1/2" ..... 94  
 DOUILLE IMPACT 3/4" ..... 95  
 DOUILLE PLASTIQUE AVEC VIS ..... 459  
 DOUILLE PORTE-EMBOUTS 1/4" ..... 69  
 DOUILLE PORTE-EMBOUTS 3/8" ..... 77  
 DOUILLE TOURNEVIS 1/2" ..... 82  
 DOUILLE TOURNEVIS 1/4" ..... 69  
 DOUILLE TRAVERSANTE «MEDIUM» ..... 88  
 DUOBAG ..... 39  
 DUOBAG ÉLECTRICITÉ 53 PIÈCES ..... 57  
 DUOBAG MAINTENANCE 80 PIÈCES ..... 57

## E

EASY BAG ÉLECTRICITÉ 47 PIÈCES ..... 56  
 EASY BAG GARNI 24 PIÈCES ..... 56  
 EASY BAG MEDIUM FRESH LINE ..... 38  
 EASY BAG S ..... 37  
 EASY JACKET ..... 41  
 EASYBAG PLOMBERIE 53 PIÈCES ..... 56  
 EASYJOINT 17 L ..... 456  
 ÉBAVUREUR TONNEAU ..... 322  
 ÉCHASSES ..... 419  
 ÉCLAIRAGE ..... 329  
 ÉCRAN DE PROTECTION ..... 503  
 EMBOUT DOUILLE MAGNETIQUE ..... 149  
 EMBOUT PLASTIQUE ..... 242  
 EMBOUT PORTE-DOUILLE ..... 151  
 EMBOUTS DE VISSAGE GAMME S2 ..... 150  
 EMBOUTS DOUILLE ..... 149  
 EMBOUTS FENTE ..... 144  
 EMBOUTS HEXAGONAUX ..... 148  
 EMBOUTS PHILLIPS ..... 145  
 EMBOUTS PLASTIQUE POUR RÈGLE ..... 427  
 EMBOUTS POZIDRIV ..... 146  
 EMBOUTS RÉVERSIBLES ..... 149  
 EMBOUTS SPANNER ..... 148  
 EMBOUTS TORX ..... 147  
 EMPORTE-PIÈCE ..... 252  
 EMPORTE-PIÈCE ..... 252  
 ENROULEUR ÉLECTRIQUE ..... 504  
 ENTONNOIR À BANCHE ..... 360  
 ENTONNOIR DE RÉCEPTION ..... 515  
 ÉPANDÉUR À BÉTON ..... 347  
 ÉPONGE DE CARRELEUR ..... 460  
 ÉPONGE DE CIMENTIER ..... 371  
 ÉPONGE DE MAÇON ..... 371  
 ÉPONGE EN MOUSSE POLYURÉTHANE ..... 435  
 ÉPONGE NATURELLE GERBIS ..... 435  
 ÉPONGE VÉGÉTALE RENFORCÉE ..... 435

ÉQUERRE 45° ..... 453  
 ÉQUERRE À 45° À CHAPEAU ..... 233  
 ÉQUERRE À CENTRER ..... 233  
 ÉQUERRE À TALON AVEC ÉCHARPE ..... 414  
 ÉQUERRE ALUMINIUM ..... 242  
 ÉQUERRE DE MAÇON ..... 289  
 ÉQUERRE DE MENUISIER ..... 242  
 ÉQUERRES À CHAPEAU ..... 232  
 ÉQUERRES BÂTIMENT ..... 242  
 ÉQUERRES DE MÉCANICIEN ..... 232  
 EQUIPEMENT DE PROTECT. INDIV. .... 499  
 ERGOLAME® ..... 480  
 ESCABEAU ACIER ..... 307  
 ESCABEAU ALUMINIUM ..... 305  
 ETABLI DE PLAQUISTE ..... 414  
 ÉTAI 3ÈME MAIN ..... 403  
 ÉTAI DE COIN ..... 387  
 ÉTAI TIRANT-POUSSANT ..... 386  
 ÉTAU À SERRE-TUBES ..... 328  
 ÉTAU MAGNAT ..... 327  
 ÉTAUX POUR MACHINES-OUTILS ..... 328  
 ETRIER DE COFFRAGE ..... 293  
 ETUI COUTEAU POUR ISOLATION ..... 413  
 ÉTUI DE CLÉS MÂLES ..... 138  
 ETUI DE CRAIES DE BRIANÇON ..... 243  
 ÉTUI DE LAMES DE CUTTER ..... 198  
 EXTRACTEURS ..... 337  
 EXTRACTEURS DE VIS ABÎMÉES ..... 338

## F

FAÇADES ..... 369  
 FARDIER ..... 517  
 FAUSSE ÉQUERRE ALUMINIUM ..... 414  
 FAUSSE ÉQUERRE DE MENUISIER ..... 242  
 FER À MARCHÉ PLASTIQUE ..... 384  
 FEUTRE ..... 243  
 FILET DE PROTECTION ..... 510  
 FIXE-RÈGLE PAR VÉRIN ..... 426  
 FLEX BOÎTE À OUTILS TEXTILE ..... 37  
 FROTTOIR BOIS ..... 371  
 FROTTOIR EN POLYSTYRÈNE ..... 371  
 FROTTOIR SPONGIEUX ORANGE ..... 431  
 FUSION BOX ..... 46  
 FUSION BOX 1/4 1/2 TEXTILE ..... 50  
 FUSION BOX 3 COFFRETS ..... 51  
 FUSION BOX CARGO - 1/4" - 1/2" 70 PIÈCES ..... 47  
 FUSION BOX CARGO VIDE ..... 47  
 FUSION BOX N°1 SMALL POUR VISSERIE ..... 46  
 FUSION BOX N°3 MEDIUM VIDE ..... 46  
 FUSION BOX TEXTILE GARNI ..... 49

## G

G LOCK TAJIMA® ..... 236  
 G-3LOCK TAJIMA® ..... 236  
 GABARIT DE FORME ..... 447  
 GÂCHOIR AVEC MANCHE ..... 430  
 GANTS ..... 500  
 FROTTOIR PLASTIQUE SPONGIEUX ORANGE ..... 431  
 GENOUILLÈRES CARRELAGE ..... 448  
 GENOUILLÈRES GEL CONFORT ..... 499  
 GILET DE SÉCURITÉ ..... 504  
 GORILLA BAR ..... 295  
 GORILLA GRIPPER ..... 389  
 GOUGE DE SCULPTEUR ..... 222  
 GOULOTTES A GRAVATS ..... 515  
 GRAND TRUSQUIN DE PLAQUISTE ..... 415  
 GRATTE-JOINT ..... 460  
 GRATTOIR À COFFRAGE ..... 345  
 GRATTOIR COURBE ..... 287  
 GRATTOIR TAJIMA® ..... 434  
 GRATTOIR TRIANGULAIRE ..... 287  
 GRIFFE À REMBLAI ..... 346  
 GRIFFE DE FERRAILLEUR ..... 289  
 GRILLAGE AVERTISSEUR ..... 516  
 GUILLAUME ..... 430

## H

HACHE FRANÇAISE ..... 282  
 HACHETTE ..... 281  
 HACHETTE DE MAÇON MANCHE FRÈNE ..... 280  
 HACHETTE DE POMPIER ..... 282  
 HÉLICE ..... 509  
 HI-TRAC ..... 337

## I

INITIAL CLÉ DYNAMOMÉTRIQUE ..... 122

## J

JALON ROUGE ET BLANC ..... 246  
 JAUGE DE FILETAGE ..... 231  
 JAUGE DE PROFONDEUR DIGITALE ..... 227  
 JAUGE DE PROFONDEUR VERNIER ..... 227  
 JAUGE ÉPAISSEUR MÉTRIQUES ..... 231  
 JAUGES À RAYON ..... 231  
 JERRICAN ..... 504  
 JEU DE 4 COINS ROULE-MEUBLES ..... 493  
 JEU DE 4 PINCES BI-MATIÈRE ..... 161  
 JEU DE CISEAUX DE SCULPTEUR ..... 222  
 JEU DE CLÉS À CLIQUET 4X4 ..... 109  
 JEU DE CLÉS À FOURCHES ..... 112  
 JEU DE CLÉS À PIPE ..... 102  
 JEU DE CLÉS ARTICULÉES ..... 107  
 JEU DE CLÉS MÂLES ..... 141  
 JEU DE CLÉS MIXTES ..... 100  
 JEU DE CLÉS MIXTES À CLIQUET ..... 105  
 JEU DE CLÉS POLYGONALES ..... 114  
 JEU DE D'EMBOUTS ..... 154  
 JEU DE LIMES AIGUILLES ..... 211  
 JEU DE LIMES DE TRONÇONNEUSE ..... 214  
 JEU DE LIMES ET RÂPES ..... 217  
 JEU DE PINCES À CIRCLIPS ..... 173  
 JEU DE TOURNEVIS ..... 131  
 JEU DE TOURNEVIS ISOLÉS ..... 136  
 JEU DE TOURNEVIS MICRO ..... 137  
 JEUX D'EXTRACTEURS HI-TRAC ..... 337  
 JOINT PÉRIPHÉRIQUE ..... 454  
 JONG+GOUPILLE DOUILLE IMPACT ..... 95  
 JUGULAIRE POUR CASQUE BRENNUS ..... 503

## K

KIT À JOINTS CARRELAGE ..... 455  
 KIT DE TRAÇAGE ..... 230  
 KIT FINITION FAÇADE ..... 368

## L

LAME À ARASER ..... 433  
 LAME DE RECHANGE ..... 252  
 LAME DE RECHANGE RABOT-RÂPE ..... 417  
 LAME DE RECHANGE SCIE À BÛCHE ..... 194  
 LAME DE RECHANGE TAJIMA® ..... 195  
 LAME ERGOLAME® ..... 480  
 LAME SCIE A METAUX ..... 191  
 LAMES CROCHET TAJIMA® ..... 196  
 LAMES GRATTE-JOINT ..... 460  
 LAMES TOURNEVIS RÉVERSIBLES ..... 133  
 LAMES TRAPÈZE ..... 197  
 LAMES TRAPÈZE POUR TRUSQUINS ..... 416  
 LAMES TRAPÈZE TAJIMA® COUTEAU ..... 196  
 LAMPE DE POCHE ..... 330  
 LAMPE FRONTALE ..... 329  
 LAMPE MAGNÉTIQUE TÉLESCOPIQUE ..... 330  
 LAMPE POCKET ..... 330  
 LAMPE POUR CASQUE OU CASQUETTE ..... 330  
 LAMPE SLIMLED ..... 332  
 LAQUEUR ..... 438  
 LETTRES À FRAPPER ..... 231  
 LEVAGE ..... 493  
 LÈVE CHARGE ..... 319  
 LÈVE-PORTE ..... 493  
 LEVIER À PANNEAUX ..... 418

LEVANO COMBI® ..... 401  
 LEVANO® I ..... 395  
 LEVANO® II ..... 397  
 LEVANO® MASTER ..... 399  
 LIENS ..... 348  
 LIEUR AUTOMATIQUE ..... 348  
 LIME AIGUILLE CARRÉE ..... 210  
 LIME AIGUILLE COUTEAUX ..... 210  
 LIME AIGUILLE DEMI-RONDE ..... 210  
 LIME AIGUILLE PILIER ..... 210  
 LIME AIGUILLE RONDE ..... 210  
 LIME AIGUILLE TRIANGULAIRE ..... 210  
 LIME CARRÉE ..... 207  
 LIME COUTEAU ..... 208  
 LIME DE TRONÇONNEUSE ..... 214  
 LIME DEMI-RONDE ..... 206  
 LIME DEMI-RONDE ..... 207  
 LIME FRAISEUSE À SOIE ..... 209  
 LIME PLATE À MAIN ..... 205  
 LIME PLATE À SCIES ..... 213  
 LIME PLATE À SCIES ..... 214  
 LIME PLATE POINTUE ..... 206  
 LIME PLATE SPÉCIALE STRATIFIÉ ..... 208  
 LIME POUR MÉTAUX TENDRES ..... 209  
 LIME RONDE ..... 208  
 LIME RONDE DE TRONÇONNEUSE ..... 214  
 LIME SPÉCIALE TONDEUSE ..... 214  
 LIME TRIANGULAIRE ..... 207  
 LIMES D'AFFÛTAGE ..... 212  
 LIMES DE MÉCANIQUE ..... 205  
 LIMES MIXTES ..... 216  
 LIMES TYPE GENÈVE ..... 218  
 LIMITEURS DE COUPLE ..... 125  
 LISSARDE À BÉTON ..... 378  
 LISSEUSE À BÉTON ..... 379  
 LOUCHE DE PLÂTRIER ..... 430  
 LUNETTES DE PROTECTION ..... 502  
 LUNETTES-MASQUE ..... 502

## M

MACHINE À CRÉPIR "LA GUËPE®" ..... 371  
 MACHINE À CRÉPIR "LE MOUSTIC®" ..... 371  
 MACHINE À DÉCOUPER LES JOINTS ..... 253  
 MACHINE À ENCOLLER ..... 433  
 MAGNAT ..... 327  
 MAGNÉTISEUR-DÉMAGNÉTISEUR ..... 143  
 MAGNUM ..... 246  
 MAILLET À EMBOUTS INTERCH ..... 268  
 MAILLET BÉTONNIÈRE ..... 270  
 MAILLET BOIS ..... 270  
 MAILLET CAOUTCHOUC ..... 270  
 MAILLET DE MENUISIER ..... 270  
 MAILLET DE SCULPTEUR ..... 270  
 MAILLET DYNACHOC ..... 266  
 MAILLET EN PEAU DE BUFFLE ..... 270  
 MAILLET NYLON ..... 269  
 MAILLET PLASTIQUE ..... 269  
 MAILLET SANS REBOND ..... 267  
 MAILLET SANS REÇUL ..... 268  
 MAILLET TP ..... 270  
 MALAXEUR HÉLICE ..... 434  
 MALLETTTE ALUMINIUM 51 PIÈCES ..... 58  
 MALLETTTE ALUMINIUM CISEAUX ..... 223  
 MANCHE À BALAIS ..... 513  
 MANCHE ACIER ÉPANDÉUR ..... 347  
 MANCHE DE CENTRAGE ..... 251  
 MANCHE DE LIMES ET RÂPES ..... 217  
 MANCHE DE MAILLET ..... 284  
 MANCHE DE MARTEAUX ..... 283  
 MANCHE DE MASSETTE ..... 283  
 MANCHE DE MASSETTE NERTECH ..... 284  
 MANCHE DE PIOCHE ..... 344  
 MANCHE DE RECHANGE CISEAUX A BOIS ..... 222  
 MANCHE GRATTOIR À COFFRAGE ..... 345  
 MANCHE POUR PELLE ..... 343  
 MANCHE POUR RACLETTE ..... 459



# INDEX ALPHABÉTIQUE

MANCHE RATEAUX ET RACLOIRS.....	347	MODULE OUTILS DE FRAPPE.....	27	PINCE À RIVETER.....	182	PLOMBETTE.....	247
MARCHEPIED MULTI.....	311	MODULE PINCES.....	26	PINCE À SERTIR.....	183	POCHÉ À CLOUS.....	42
MARCHEPIED PLIANT ACIER.....	309	MODULE POUR BOITE A OUTILS.....	36	PINCE À TALON.....	298	POCHÉ À JOINTS.....	460
MARCHEPIED PLIANT ALUMINIUM.....	308	MOLETTE DE RECHANGE BASIC PLUS.....	444	PINCE BIMATIÈRE.....	159	POCHÉ À OUTILS.....	41
MARQUAGE BÂTIMENT.....	243	MOLETTE DE RECHANGE SUPER PRO.....	446	PINCE COUPANTE À RAS.....	166	POIGNÉE ARTICULÉE 1/2".....	82
MARTEAU À MAIN PANNE EN LONG.....	260	MONTURE A ARC.....	209	PINCE COUPANTE DIAGONALE.....	159	POIGNÉE ARTICULÉE 1/4".....	69
MARTEAU À PIQUER LES SOUDURES.....	261	MONTURE À VIS ET BAGUE FIXE.....	441	PINCE COUPANTE FRONTALE.....	160	POIGNÉE ARTICULÉE 3/8".....	77
MARTEAU À BRIQUES.....	279	MONTURE AUTOBLOQUANTE.....	441	PINCE COUPANTE SEMI-RASE.....	166	POIGNÉE COULISSANTE 1".....	93
MARTEAU À DÉBOSSSELER.....	264	MONTURE DE CLÉS MÂLES.....	139	PINCE COUPE-CARREAUX.....	447	POIGNÉE COULISSANTE 1/2".....	82
MARTEAU À EMBOUTIR.....	262	MONTURE RADIATEUR AUTOBLOQUANTE.....	441	PINCE DE MONTEUR.....	297	POIGNÉE COULISSANTE 1/4".....	69
MARTEAU À FORCE ROTATRICE.....	264	MORDACHE.....	327	PINCE DE MOSAÏSTE.....	447	POIGNÉE COULISSANTE 3/4".....	91
MARTEAU À GARNIR.....	262	MORDACHES.....	328	PINCE DE PAVEUR.....	299	POIGNÉE COULISSANTE 3/8".....	77
MARTEAU À MAIN.....	260	MULTI.....	311	PINCE DE PRÉCISION MICRO.....	160	POIGNÉE PARE-COUPS.....	285
MARTEAU À PLANER.....	262	MULTI PACK ÉLECTRICIEN.....	165	PINCE EMPORTE-PIÈCE.....	184	POIGNÉE PORTE-EMBOUTS.....	151
MARTEAU À RETREINDRE.....	263	MULTI, MARCHEPIED MULTIFONCTION.....	311	PINCE ÉTAUX.....	175	POIGNÉE RÉVOLVER À CLIQUET + EMBOUTS.....	152
MARTEAU ANGLAIS.....	261	MULTIPRISE RAPIDE.....	170	PINCE ISOLÉES 1000 V.....	159	POIGNÉE SPINPOWER PORTE-EMBOUT.....	152
MARTEAU BOURGEOIS.....	277	MULTI-TOOL.....	200	PINCE MONSEIGNEUR.....	297	POIGNÉE TOURNEVIS 1/4".....	69
MARTEAU DE BIJOUTIER.....	282	<b>N</b>		PINCE MULTICOUPE.....	447	POINÇON À ŒIL.....	263
MARTEAU DE CARROSSIER.....	262	NÉCESSAIRE À JOINT.....	456	PINCE MULTIPRISE À BECS EFFILÉS.....	169	POINTE À TRACER.....	230
MARTEAU DE CHARPENTIER.....	278	NID D'ABEILLE GAMME PRO.....	438	PINCE MULTIPRISE AUTOBLOQUANTE.....	170	POINTEAU AUTOMATIQUE.....	287
MARTEAU DE CHAUDRONNIER.....	262	NINJA.....	312	PINCE MULTIPRISE ENTREPASSÉE.....	168	POINTEAU DE MÉCANICIEN.....	287
MARTEAU DE COFFREUR.....	276	NIVEAU À EAU.....	409	PINCE MULTIPRISE ISOLÉE.....	169	POLYESTER MAILLE GAMME PRO.....	438
MARTEAU DE FORGE.....	263	NIVEAU D'ANGLE AIMANTÉ.....	239	PINCE MULTIPRISE RAPIDE.....	170	PONCEUSE À MANCHE.....	422
MARTEAU DE LYON.....	277	NIVEAU MOB.....	240	PINCE MULTIPRISE SUPERPOSÉE.....	168	PORTE EMBOUT MAGNÉTIQUE.....	151
MARTEAU DE MAÇON.....	279	NIVEAU MONDELIN.....	239	PINCE MULTIPRISE ZOOMER.....	171	PORTE-DOCUMENTS.....	30
MARTEAU DE MÉCANICIEN.....	258	NIVEAU POUR RÈGLE DE MAÇON.....	241	PINCE PVC.....	159	PORTE-EMBOUTS MAGNÉTIQUE.....	151
MARTEAU DE MENUISIER.....	272	NIVEAU PROFIL RECTANGULAIRE.....	239	PINCE RÉVOLVER TUBE.....	184	PORTE-FLACONS.....	30
MARTEAU DE MINÉRALOGISTE.....	282	NIVEAU TRAPÈZE.....	239	PINCE UNIVERSELLE.....	160	PORTE-MARTEAU.....	41
MARTEAU DE TAPISSIER.....	282	NIVEAUX À EAU.....	239	PINCEAU MOUILLEUR COCO.....	514	PORTE-OUTILS.....	41
MARTEAU DE VITRIER.....	282	NIVOLINER NIVEAU COURT.....	240	PIOCHE.....	344	PORTE-OUTILS.....	313
MARTEAU D'ÉLECTRICIEN.....	271	<b>O</b>		PIQUET DE CHANTIER.....	517	PORTE-OUTILS À CLIQUET.....	335
MARTEAU D'EMBALLER U.S.....	277	ODOMETRE.....	238	PIRL NINJA.....	312	PORTE-OUTILS AMOVIBLE.....	305
MARTEAU EUROPE CENTRALE.....	261	OUTILS D'INSPECTION.....	333	PISTOLET À CARTOUCHES.....	506	PORTE-OUTILS ÉLECTROPORTATIF.....	41
MARTEAU PANNES OPPOSÉES.....	262	PANNEAU.....	518	PISTOLET À COLLE.....	506	PORTE-OUTILS MÉTALLIQUE.....	357
MARTEAU POSTILLON.....	262	<b>P</b>		PISTOLET SQUELETTE.....	376	PORTE-OUTILS TEXTILE.....	41
MARTEAU RIVOIR DE MÉCANICIEN.....	258	PAPIER.....	507	PISTOLET TAJIMA®.....	506	PORTE-ROULEAU.....	30
MARTEAU RIVOIR DE MÉCANICIEN PROTECT.....	259	PAPIER ABRASIF.....	422	PLANCHE STICKERS.....	30	POSE BORDURES DÉMONTABLE.....	358
MARTEAU SÉCURIPLUS.....	260	PAPIER ABRASIF DE RECHANGE.....	370	PLAQUE FRAISEUSE.....	209	POSE-DALLES.....	452
MARTEAU U.S. X STRIKER.....	277	PARE-COUPS.....	285	PLAQUETTE POUR BOUCHARDE.....	280	POSE-LAME.....	387
MARTELETTE MARSEILLAISE.....	280	PATIN ÉLEVATEUR DE MEUBLES.....	494	PLATEAU «PLUME» PLÂTRIER.....	431	POTEAU D'ANGLE.....	359
MARTELETTE TÊTE ET PIC.....	280	PATIN ROULE-MEUBLES.....	493	PLATEAU DE RECHANGE TALOCHE.....	367	POUBELLE.....	514
MASQUE D'HYGIÈNE.....	502	PATINS DE CARRELEUR.....	448	PLATEAU MAGNÉTIQUE.....	333	POUCE À RECHAMPIR.....	436
MASQUE RESPIRATOIRE.....	502	PEIGNE À COLLE.....	450	PLATEAU MOUSSE INTERCHANGEABLE.....	473	POUDRE À TRACER.....	244
MASSE.....	275	PELLE.....	342	PLATEAU TOURNANT POUR ÉTAUX.....	327	POULIE TYPE "CLIC".....	498
MASSETTE 4U MANCHE NERTECH.....	274	PELLE À NEIGE OU À GRAIN.....	343	PLATEFORME DE LEVAGE.....	403	PROBLADE.....	201
MASSETTE À EMBOUTS.....	269	PELLE À POUSSIÈRE.....	514	PLATEFORME DE TRAVAIL ALU.....	313	PROJOINT®.....	455
MASSETTE ANGLÉS ABATTUS.....	274	PELLE BORDEAUX.....	343	PLATINES ARASEMENT.....	312	PROTECTION DU CHANTIER.....	361
MASSETTE CARRÉE.....	273	PELLE MICRO MULTIFONCTION.....	343	PLATOIR À GRÉSER.....	472	PROTECTION POUR FER À BÉTON.....	361
MASSETTE CONIQUE.....	274	PERCE-CARREAUX GRADUÉ.....	447	PLATOIR À JOINTER.....	472	PULVÉRISATEUR.....	505
MASSETTE CORPS ACIER LOURD.....	269	PERCEUSE À MAIN.....	338	PLATOIR À NETTOYER.....	473	<b>Q</b>	
MASSETTE CUIVRE.....	265	PERCHE ERGOLAME.....	481	PLATOIR "ALSACE".....	470	QUEUE DE MORUE.....	437
MASSETTE ESPAGNOLE.....	274	PIC À DÉGRADER.....	280	PLATOIR BISEAUTÉ.....	464	<b>R</b>	
MASSETTE SANS REBOND.....	267	PIED À COULISSE DIGITAL.....	226	PLATOIR CAOUTCHOUC.....	371	RABOT À CHANFREINER.....	416
MÉCHÉ LONG.....	439	PIED À COULISSE VERNIER.....	227	PLATOIR CHAPISTE.....	471	RABÔT À PLÂTRE.....	431
MÉLANGEUR.....	508	PIED DE POULE ALUMINIUM.....	408	PLATOIR COURBE.....	467	RABÔT À PLÂTRE.....	431
MERLIN.....	282	PIERRE À AFFÛTER.....	222	PLATOIR DENTÉ MONTURE ALU.....	467	RABOTER LA PLAQUE.....	416
MESURE.....	234	PINCE À AGRAFAGE.....	411	PLATOIR DENTÉS MONTURE FIBRE.....	468	RABOT-RÂPE DE POCHE.....	417
MESURE ROLL'UP.....	235	PINCE À AGRAFAGE DES PROFILS DOS À DOS.....	412	PLATOIR DEUX MAINS.....	465	RABOT-RÂPE MÉTALLIQUE.....	417
MESURE TAJIMA®.....	236	PINCE À AGRAFAGE UNIVERSEL.....	410	PLATOIR DEUX MAINS.....	467	RABOT-RÂPE PLASTIQUE.....	417
MESURES LONGUES ET LASER.....	237	PINCE À BÂTIR.....	425	PLATOIR DEUX MAINS.....	467	RACKS DE DOUILLES 1/2" 14 PIÈCES.....	79
MESURES MOB.....	234	PINCE À BECS DEMI-RONDS.....	160	PLATOIR DEUX MAINS.....	467	RACKS DE DOUILLES 1/4" 12 PIÈCES.....	66
MESURES MONDELIN.....	236	PINCE À BECS DEMI-RONDS COUDÉS.....	160	PLATOIR DEUX MAINS.....	467	RACLETTE BOIS.....	459
MESURES PLIANTES.....	237	PINCE À BECS PLATS.....	163	PLATOIR DEUX MAINS.....	467	RACLETTE DE CARRELEUR.....	459
MESURES TAJIMA®.....	236	PINCE À BECS RONDS.....	161	PLATOIR DEUX MAINS DENTÉ.....	465	RACLOIR À BITUME.....	346
MÉTROLOGIE.....	226	PINCE À CHEVILLES.....	410	PLATOIR ESPAGNOL.....	469	RACLOIR À PEINTURE.....	434
MICROMÈTRE.....	227	PINCE À CIRCLIPS.....	172	PLATOIR FLAMAND.....	471	RACLOIR RABOT À BOUE.....	346
MINI COUPE-TUBE CUIVRE.....	321	PINCE À DÉCOFFRER.....	296	PLATOIR LAME ACIER.....	464	RADIATEUR.....	438
MINI ROLL'UP.....	234	PINCE À DÉNUDER AUTOMATIQUE.....	183	PLATOIR LAME COURBE PLAQUISTE.....	421	RALENTISSEUR À GRAVATS.....	515
MINI-GÉANT 30 M.....	246	PINCE À DÉNUDER RÉGLABLE.....	161	PLATOIR LAME INOX SOUPLE.....	470	RALLONGE 1".....	93
MINI-RÈGLE ALU.....	453	PINCE À RIPER.....	299	PLATOIR MONOBLOC MOUSSE.....	474	RALLONGE 1/2".....	82
MIROIR TÉLESCOPIQUE.....	333	<b>Q</b>		PLATOIR MONTURE ALU.....	464	RALLONGE 1/4".....	68
MODULE DE CALAGE.....	27	PINCE À RIVETER.....	182	PLATOIR MONTURE ALU LAME INOX.....	464	RALLONGE 3/4".....	91
MODULE DE CLÉS.....	25	PINCE À SERTIR.....	183	PLATOIR MONTURE FIBRE DE VERRE.....	468	RALLONGE 3/8".....	77
MODULE DE DOUILLES ET CLIQUETS.....	25	PINCE À TALON.....	298	PLATOIR MONTURE ALU LAME INOX.....	464	RALLONGE DÉBOUCHANTE.....	88
MODULE DE LIMES.....	27	PINCE BIMATIÈRE.....	159	PLATOIR MONTURE FIBRE DE VERRE.....	468	RALLONGE FLEXIBLE 1/4".....	68
MODULE DE RANGEMENT MOUSSE.....	27	PINCE COUPANTE À RAS.....	166	PLATOIR MONTURE ALU.....	466		
MODULE DE TOURNEVIS.....	26	PINCE COUPANTE DIAGONALE.....	159	PLATOIR MONTURE ALU LAME INOX.....	464		
		PINCE COUPANTE FRONTALE.....	160	PLATOIR MONTURE FIBRE DE VERRE.....	468		
		PINCE COUPANTE SEMI-RASE.....	166	PLATOIR POIGNÉE BANANE.....	464		
		PINCE COUPE-CARREAUX.....	447	PLATOIR "SUISSE".....	469		
		PINCE DE MONTEUR.....	297	PLATOIR-RÂPE I.T.E.....	376		
		PINCE DE MOSAÏSTE.....	447	PLOMB DE MAÇON.....	247		
		PINCE DE PAVEUR.....	299	PLOMB POUR ÉTAI.....	387		
		PINCE DE PRÉCISION MICRO.....	160	PLOMB TOUPIE.....	247		
		PINCE EMPORTE-PIÈCE.....	184				
		PINCE ÉTAUX.....	175				
		PINCE ISOLÉES 1000 V.....	159				
		PINCE MONSEIGNEUR.....	297				
		PINCE MULTICOUPE.....	447				
		PINCE MULTIPRISE À BECS EFFILÉS.....	169				
		PINCE MULTIPRISE AUTOBLOQUANTE.....	170				
		PINCE MULTIPRISE ENTREPASSÉE.....	168				
		PINCE MULTIPRISE ISOLÉE.....	169				
		PINCE MULTIPRISE RAPIDE.....	170				
		PINCE MULTIPRISE SUPERPOSÉE.....	168				
		PINCE MULTIPRISE ZOOMER.....	171				
		PINCE PVC.....	159				
		PINCE RÉVOLVER TUBE.....	184				
		PINCE UNIVERSELLE.....	160				
		PINCEAU MOUILLEUR COCO.....	514				
		PIOCHE.....	344				
		PIQUET DE CHANTIER.....	517				
		PIRL NINJA.....	312				
		PISTOLET À CARTOUCHES.....	506				
		PISTOLET À COLLE.....	506				
		PISTOLET SQUELETTE.....	376				
		PISTOLET TAJIMA®.....	506				
		PLANCHE STICKERS.....	30				
		PLAQUE FRAISEUSE.....	209				
		PLAQUETTE POUR BOUCHARDE.....	280				
		PLATEAU «PLUME» PLÂTRIER.....	431				
		PLATEAU DE RECHANGE TALOCHE.....	367				
		PLATEAU MAGNÉTIQUE.....	333				
		PLATEAU MOUSSE INTERCHANGEABLE.....	473				
		PLATEAU TOURNANT POUR ÉTAUX.....	327				
		PLATEFORME DE LEVAGE.....	403				
		PLATEFORME DE TRAVAIL ALU.....	313				
		PLATINES ARASEMENT.....	312				
		PLATOIR À GRÉSER.....	472				
		PLATOIR À JOINTER.....	472				
		PLATOIR À NETTOYER.....	473				
		PLATOIR "ALSACE".....	470				
		PLATOIR BISEAUTÉ.....	464				
		PLATOIR CAOUTCHOUC.....	371				
		PLATOIR CHAPISTE.....	471				
		PLATOIR COURBE.....	467				
		PLATOIR DENTÉ MONTURE ALU.....	467				
		PLATOIR DENTÉS MONTURE FIBRE.....	468				
		PLATOIR DEUX MAINS.....	465				
		PLATOIR DEUX MAINS.....	467				
		PLATOIR DEUX MAINS.....	467				
		PLATOIR DEUX MAINS DENTÉ.....	465				
		PLATOIR ESPAGNOL.....	469				
		PLATOIR "FLAMAND".....	471				
		PLATOIR LAME ACIER.....	464				
		PLATOIR LAME COURBE PLAQUISTE.....	421				
		PLATOIR LAME INOX SOUPLE.....	470				
		PLATOIR MONOBLOC MOUSSE.....	474				
		PLATOIR MONTURE ALU.....	464				
		PLATOIR MONTURE ALU.....	466				
		PLATOIR MONTURE ALU LAME INOX.....	464				
		PLATOIR MONTURE FIBRE DE VERRE.....	468				
		PLATOIR POIGNÉE BANANE.....	464				
		PLATOIR "SUISSE".....	469				
		PLATOIR-RÂPE I.T.E.....	376				
		PLOMB DE MAÇON.....	247				
		PLOMB POUR ÉTAI.....	387				
		PLOMB TOUPIE.....	247				



RALLONGE IMPACT 1/2".....	94	SEAU DE MAÇON PLASTIQUE.....	350	TIERS POINT ANGLES RONDS.....	212	TRUELLE CARRÉE.....	486
RALLONGE IMPACT 3/4".....	95	SEAU DE MAÇON PROCHOK®.....	351	TIERS POINT EFFILÉ.....	213	TRUELLE RONDE.....	486
RÂPE CABINETTE CHAISIÈRE.....	216	SERRE-JOINT DE MAÇON.....	294	TIERS POINT MACHETTE.....	213	TRUELLE INOX MANCHE BIMATIÈRE.....	487
RÂPE DEMI-RONDE.....	215	SERRE-JOINT RAPIDE.....	293	TIERS POINT TRES EFFILÉ.....	213	TRUSQUIN DE PLAQUISTE.....	416
RÂPE PLATE À MAIN.....	215	SERRE-TÊTE ANTI-BRUIT.....	502	TIGE MÉTALLIQUE GARDE-CORPS.....	315	TUBES FILETÉS.....	251
RÂPE RONDE.....	216	SERVANTE BASELINER.....	23	TIRE-FIL®.....	247	TUBES LISSES.....	251
RÂPE SERRURIÈRE.....	216	BASELINER.....	23	TIRE-GOUPILLES.....	287	TUYAU POUR NIVEAU À EAU.....	239
RAPID-LINE.....	245	SERVANTE CLASSIC.....	24	TIRE-MUR.....	388	TWINBAR DOUBLE FOURCHE.....	299
RAPPORTEUR D'ANGLE.....	233	CLASSIC.....	24	TOILE ÉMÉRI.....	507		
RÂTEAU.....	346	SERVANTE PROLINER.....	22	TOPSECURITY.....	198	<b>U</b> .....	
RÉDUCTEUR CARRÉ 1/2" À 3/8".....	82	PROLINER.....	22	TOURNEVIS DYNAMOMÉTRIQUE.....	124	ULTRA.....	445
RÉDUCTEUR CARRÉ 3/8" A 1/4".....	77	SERVANTE XLINER.....	19	TOURNEVIS DE MÉCANICIEN.....	129		
RÈGLE «H».....	427	XLINER.....	19	TOURNEVIS D'ÉLECTRICIEN.....	129	<b>V</b> .....	
RÈGLE À BÂTIR.....	424	SERVANTE XLINER AVEC ARMOIRE.....	21	TOURNEVIS PHILLIPS.....	129	VALISE ALUMINIUM.....	43
RÈGLE À DRESSER.....	427	SERVANTES GARNIES - 109 PIÈCES.....	31	TOURNEVIS CARRÉ.....	130	VALISE ALUMINIUM 125 PIÈCES.....	58
RÈGLE À FILAMENT.....	229	SERVANTES GARNIES - 126 PIÈCES.....	32	TOURNEVIS POZIDRIV.....	130	VALISE ALUMINIUM 128 PIÈCES.....	59
RÈGLE À NIVEAUX.....	241	SERVANTES GARNIES - 141 PIÈCES.....	31	TOURNEVIS TAMPER TORX.....	130	VALISE TROLLEY ABS 128 PIÈCES.....	60
RÈGLE ALU DE CARRELEUR.....	453	SERVANTES GARNIES - 156 PIÈCES.....	32	TOURNEVIS TORX.....	130	VALISE TROLLEY ABS VIDE.....	43
RÈGLE ALU MAÇON.....	241	SERVANTES GARNIES - 173 PIÈCES.....	32	TOURNEVIS MULTILAMES.....	133	TROLLEY ALUMINIUM 128 PCS.....	60
RÈGLE ALUMINIUM PLÂTRIER.....	426	SET MULTI-TOOL.....	200	TOURNEVIS À FRAPPER.....	134	VALISE TROLLEY ALUMINIUM.....	43
RÈGLE ALUMINIUM CARRÉE.....	426	SLIMBAG PLOMBERIE.....	56	TOURNEVIS COUDÉS.....	134	VENTOUSE DOUBLE.....	453
RÈGLE DE MAÇON 2 VOILES.....	242	SPALTER.....	437	TOURNEVIS ISOLÉS 1000 V.....	135	VENTOUSE SIMPLE.....	452
RÈGLE NON GRADUÉE.....	229	SPATULE À COLLE.....	451	TOURNEVIS ISOLÉ 1000 V BORNIER.....	136	VÉS.....	229
RÈGLE POSE-FOURRURES.....	408	SPATULE EXTRA-SOUPLE.....	476	BORNIER.....	136		
RÈGLE PROFIL «D» POUR FAÇADIER.....	242	SPÉCIAL I.T.E.....	376	TOURNEVIS TESTEUR.....	136	<b>X</b> .....	
RÈGLE REPORT DE TRACÉ.....	409	SPIN POWER 1/2".....	80	TOURNEVIS DE PRÉCISION MICRO.....	137	XS BOX.....	71
RÈGLE TÉLESCOPIQUE.....	425	SPIN POWER 1/4".....	68	TOURNEVIS PORTE-EMBOUT.....	151		
RÉGLET INOX FLEXIBLE.....	229	SPIN POWER RALLONGE IMPACT 1/2".....	94	TRACAGE BÂTIMENT.....	244	<b>Z</b> .....	
RÉGLET INOX SEMI-RIGIDE.....	229	STAND DE CHASSE-GOUPILLES.....	288	TRACAGE PLAQUES.....	407	ZOOMER.....	171
RÉGLETTE.....	430	STOPLINE.....	245	TRACE-ESCALIER.....	407		
RÉSERVATION PIED DE GARDE-CORPS.....	361	STRIPANO®.....	412	TRACETTE CARBURE.....	230		
RIFLARD.....	479	STUCATEUR INOX.....	487	TRAÇEUR DE CHANTIER TRACE.....	244		
RIFLARD DE MAÇON.....	292	SUPER PRO.....	446	TRANCHE À CHAUD.....	263		
RIFLARD MONOBLOC.....	292	SUPPORT AIMANTÉ COMPARATEUR.....	228	TRANCHE À FROID.....	263		
ROLICORD®.....	246	SUPPORT DE PINCEAU.....	441	TRANCHET D'ENCLUME.....	263		
ROLLUP MAGNET.....	235	SUPPORT DE TRAVAIL.....	328	TRANSPORTEUR DE PLAQUES À TIGE.....	406		
RONDE A CHAÎNE.....	214	SUPPORT DE VOILETS.....	442	TRÉPIED MÉTALLIQUE DE PLÂTRIER.....	432		
RONDELLE PARE-COUPS.....	285	SUPPORT MÉTALLIQUE.....	515	TRÉPIEDS PLÂTRIER.....	432		
RONDO-LINE.....	245	SUPPORT DE VOILETS.....	442	TRESSE FLUO ROSE.....	247		
ROULEAU À DÉBULLER.....	383			TRESSE POLYPROPYLENE BLANCHE.....	247		
ROULEAU APPLICATEUR DE COLLE.....	362	<b>T</b> .....		TRÉTEAU MÉTALLIQUE DE MAÇON.....	357		
ROULEAUX ET MANCHONS.....	438	TABLE DE MONTEUR.....	323	TRÉTEAU PLIANT PROFESSIONNEL.....	314		
RUBAN DE MASQUAGE.....	434	TABLE PLATE.....	265	TRÉTEAU RÉGLABLE, POUTRE BOIS.....	315		
RUBAN DE SIGNALISATION.....	517	TAILLE-CRAYON.....	243	TREUIL MANUEL.....	515		
		TALOCHES ABS.....	363	TROLLEY BAG.....	40		
<b>S</b> .....		TALOCHES PLASTIQUES.....	363	TROLLEY BAG DÉPANNAGE.....	57		
SAC À DOS FRESH LINE.....	40	TALOCHES SUPERCHOK.....	364	TROUS BRÛLÉS GAMME PRO.....	438		
SAC À GRAVATS.....	516	TALOCHES NOIRES.....	365	TROUSSE ZIPPÉE.....	41		
SAC DE LESTAGE.....	518	TALOCHES PS CHOC.....	365	TROUSSE TEXTILE.....	55		
SAC ÉTANCHE SLIM'BAG.....	39	TALOCHES BOIS, SEMELLE MOUSSE.....	366	TROUSSE DE CLÉS MIXTES.....	100		
SANGLE À CLIQUET.....	497	TALOCHES BOIS.....	367	TROUSSE DE CLÉS À PIPE.....	102		
SANGLE FASTER.....	497	TALOCHES MONOBLOC MOUSSE.....	367	TROUSSE DE CLÉS À CLIQUET.....	105		
METALCUT.....	190	TALOCHES BOIS.....	367	TROUSSE DE CLÉS À FOURCHES.....	112		
SCIE À MÉTAUX.....	190	TALOCHES À POINTES.....	369	TROUSSE DE CLÉS À TUYAUTER.....	115		
SCIE MONTURE COURTE.....	191	TALOCHES GRATTON.....	369	TROUSSE DE CLÉS MÂLES.....	141		
NERTECHCUT II.....	192	TALOCHES ABRASIVES.....	370	TROUSSE DE MAINTENANCE.....	167		
SCIE ÉGOÏNE.....	192	TALOCHES PU.....	370	TROUSSE DE PRÉCISION.....	167		
SCIE À BÉTON CELLULAIRE.....	193	TALOCHES ALUMINIUM.....	431	TROUSSE DE LIMES.....	218		
SCIE À DOS.....	193	TALOREX.....	371	TRUELLE D'ANGLE PLAQUISTE.....	419		
SCIE À GUICHET.....	193	TAMIS.....	355	TRUELLE À BRIQUETER.....	428		
SCIE À PANNEAU.....	193	TAMPONS ABRASIFS DE RECHANGE.....	473	TRUELLE INOX MONDELIN.....	428		
SCIE CARBURE BÉTON CELLULAIRE.....	193	PROTECH TAPIS PROTECTION.....	498	TRUELLE CARRÉE DE CARRELEUR.....	450		
SCIE D'ÉBÉNISTE.....	193	TAPIS GENOUX PROTECH.....	498	TRUELLE ITALIENNE CARRÉE.....	482		
SCIE DE COFFREUR.....	193	TAS ALLÉGÉ "DÉTROIT".....	265	TRUELLE ITALIENNE RONDE.....	482		
SCIE À BÛCHE.....	194	TAS AMÉRICAIN.....	265	TRUELLE LANGUE DE CHAT.....	482		
SCIE TAJIMA® G SAW 240.....	195	TAS ÉPINÇOIR.....	265	TRUELLE TRIANGULAIRE.....	482		
SCIE TAJIMA® MAGNUM SAW 300.....	195	TÉ DE PLAQUISTE.....	415	TRUELLES "EXCELLENCE".....	482		
SCIE TAJIMA® RAPID PULL.....	195	TENAILLE DE CARRELEUR.....	447	TRUELLE À BRIQUE.....	483		
SCIE JAPONAISE TAJIMA.....	195	TENAILLE DE FORGE.....	263	TRUELLE AMÉRICAINNE RONDE.....	483		
SCIE DE PLACAGE.....	435	TENAILLE DE MENUISIER.....	177	TRUELLE BERTHELET.....	483		
SCIE TRÉPAN AU CARBURE.....	447	TENAILLE RUSSE HAUTE QUALITÉ.....	177	TRUELLE FAÇON REIMS.....	483		
SCIE VILBREQUIN CARRELEUR.....	447	TENAILLES DE FORGE.....	263	TRUELLE SORBY.....	483		
SCIOTTE LAMES.....	370	TENDEURS.....	497	TRUELLES "AUTHENTIQUE".....	483		
SEAU DE CARRELEUR.....	350	TÊTU DE MAÇON.....	280	TRUELLES FORGÉES.....	484		
SEAU DE MAÇON CAOUTCHOUC.....	351	TEXTILE FUSION BOX N°4, VIDE.....	48	TRUELLE À JOINT DEMI-RONDE.....	486		
SEAU DE MAÇON ECOCHOK.....	351	TIERS POINT ANGLES VIFS.....	212	TRUELLE À JOINT PLATE.....	486		



# INDEX DES RÉFÉRENCES MOB

## Index Mob par début de référence

Dans les références Mob à 10 chiffres, les 4 premiers chiffres renvoient au produit. Les autres chiffres sont des déclinaisons dimensionnelles ou de finition.

Exemple : 0001 désigne le roivior de mécanicien. Pour la commande en revanche, l'intégralité de la référence en 10 chiffres sera nécessaire.

0000190001.....173	0186.....279 - 280	0469.....261	0987.....214	26550.....148	6005.....484	6345.....193	6603.....284
00004100LB.....41	0190.....270	0476.....276 - 277	0990.....219	26570.....148	6006.....482	6348.....192	6604.....284
0000500301.....171	0200.....262	0478.....276	20010.....145	26580.....148	6007.....485	6349.....192	6605.....284
0000970501.....161	0204.....262	0500.....281	20020.....145	26590.....148	6008.....486	6350.....177	6606.....284
0000970901.....230	0208.....262	0502.....281	20030.....145	27850.....149	6009.....487	6357.....345	6607.....284
0000972101.....165	0209.....263	0503.....282	20080.....145	27860.....149	6011.....482	6359.....345	6608.....284
0000975901.....200	0213.....262	0504.....282	20110.....146	27870.....149	6012.....485	6360.....292	6609.....284
0000982601.....217	0225.....288	0505.....281	20120.....146	27950.....149	6013.....482	6361.....345	6610.....284
0000982701.....217	0263.....282	0514.....180	20130.....146	27960.....149	6014.....482	6362.....177	6640.....284
0000982801.....217	0281.....265	05150.....178	20180.....146	36101.....154	6015.....485	6369.....190	6650.....283
0000983401.....74	0290.....265	05151.....180	20190.....146	37380.....151	6016.....482	6373.....506	6651.....283
0000989001.....161	0298.....262	0516.....179	20210.....144	39321.....154	6017.....487	6380.....342	6652.....283
0000991701.....222	0300.....264	0518.....180 - 181	20220.....144	40034.....335	6018.....484	6381.....342	6653.....283
0000991801.....217	0301.....264	0521.....186	20240.....144	40061.....335	6021.....486	6382.....343	6660.....284
0000991901.....217	0302.....288	0522.....186	20250.....144	40071.....335	6022.....486	6383.....343	6667.....284
0000992301.....217	0304.....265	0523.....187	20260.....144	40081.....335	6023.....483	6384.....344	6668.....284
0000998001.....83	0308.....264	0524.....187	20290.....144	40091.....335	6026.....483	6387.....344	6669.....284
0000998901.....223	0311.....262	0525.....187	20610.....148	45110.....337	6027.....483	6388.....343	6670.....284
0001.....258	0313.....264	0770.....29	20630.....148	45120.....337	6029.....483	6398.....294	6800.....284
0002.....260	0314.....264	0900.....205	20640.....148	45130.....337	6031.....483	6399.....294	6801.....284
0003.....260	0321.....265	0902.....205	20650.....148	45140.....337	6059.....487	6410.....511	6802.....284
0006.....263	0322.....265	0903.....205	20660.....148	45150.....337	6062.....483	6412.....511	6803.....284
0007.....263	0330.....266	0904.....206	20670.....148	45160.....337	6072.....487	6423.....498	6804.....284
0009.....260	0331.....266	0906.....206	20690.....148	46151.....337	6155.....347	6441.....41	6805.....284
0031.....263	0332.....266	0907.....206	20840.....147	46161.....337	6156.....347	6444.....41	6806.....284
0032.....263	0334.....297	0910.....206 - 207	20850.....147	50024.....338	6193.....499	6446.....41	6807.....284
0034.....263	0337.....270	0912.....207	20860.....147	5056.....263	6202.....200	6450.....346	6808.....284
0036.....263	0343.....270	0913.....207 - 208	20870.....147	5058.....263	6217.....199 - 200	6451.....346	6809.....284
0037.....263	0346.....270	0914.....208	20890.....147	5081.....261	6218.....201	6452.....346	6820.....284
0041.....263	0347.....262	0915.....217	20900.....147	5097.....261	6228.....197 - 198	6453.....346	6821.....284
0047.....263	0348.....270	0918.....219	21010.....145	5123.....278	6229.....198	6455.....346	6822.....284
0103.....280	0352.....268	0923.....208	21020.....145	5130.....278	6232.....287	6456.....347	6852.....283
0104.....280	0355.....262	0925.....209	21030.....145	5135.....268	6244.....198	6457.....347	6853.....283
0105.....280	0360.....292	0926.....208 - 209	21110.....146	5194.....282	6245.....198	6464.....328	6854.....283
0112.....295	0361.....185 - 186	0927.....209	21120.....146	5200.....226 - 227	6247.....198	6466.....327	6870.....283
0113.....297	0362.....186	0928.....209	21130.....146	5201.....226	6248.....198	6467.....328	6871.....283
0114010000.....345	0365.....265	0929.....209	21840.....147	5202.....227	6251.....240	6468.....327	6872.....283
0114010020.....343	0367.....270	0931.....209	21850.....147	5205.....227	6264.....244	6469.....327	6873.....284
0114401000.....389	0368.....270	0932.....209	21860.....147	5210.....227	6265.....289	6470.....327	6884.....284
0114501000.....493	0369.....269	0933.....209	21870.....147	5211.....228	6270.....234 - 235	6471.....327	6911.....344
0115.....280	0370.....268	0935.....218	21890.....147	5215.....228	6272.....240	6472.....328	6925.....343
0116.....297	0371.....269	0936.....218	21900.....147	5219.....228	6273.....240	6473.....328	6926.....343
0118.....279 - 280	0374.....265	0940.....215	22340.....147	5221.....232	6275.....235	6474.....328	6927.....343
0121.....280	0375.....267	0941.....215 - 216	22350.....147	5222.....232	6283.....229	6475.....328	6941.....347
0123.....280	0376.....264	0942.....216	22360.....147	5224.....232	6285.....229	6476.....327	6950.....284
0127.....273	0377.....269	0943.....216	22370.....147	5225.....232	6299.....497	6477.....328	6954.....284
0129.....274	0380.....270	0944.....216	22390.....147	5226.....233	6300.....194	6478.....328	6955.....344
0133.....274	0391.....264	0947.....216	22400.....147	5227.....233	6301.....194	6479.....328	6956.....284
0135.....275	0395.....269	0950.....212	23010.....145	5228.....233	6302.....194	6480.....168	6958.....343
0136.....274 - 275	0396.....269	0951.....212	23020.....145	5230.....233	6303.....194	6481.....168 - 169	6959.....283
0137.....274	0398.....266	0952.....213	23030.....145	5231.....233	6304.....194	6482.....169	6971.....283
0144.....347	0400.....272	0953.....213	23050.....145	5240.....230	6305.....193	6483.....171	6972.....283
0148.....299	0402.....261	0954.....213	23070.....145	5241.....230	6309.....190	6484.....170	6973.....283
0149.....298	0403.....277	0957.....214	23080.....145	5242.....230	6310.....191	6490.....319	6978.....283
0150.....298	0405.....277	0965.....213	23110.....146	5250.....229	6311.....191	6491.....320	7000.....222 - 223
0151.....299	0407.....278	0966.....213 - 214	23120.....146	5251.....229	6312.....191	6492.....320	7007.....222
0152.....299	0409.....277	0970.....214	23130.....146	5260.....231	6313.....191	6493.....320	7010.....222
0153.....299	0416.....271	0971.....210	23150.....146	5265.....231	6314.....191	6494.....320	7020.....221 - 223
0159.....280	0430.....261	0973.....210	23840.....147	5267.....231	6317.....194	6495.....321	7025.....222
0160.....264	0435.....282	0974.....210	23850.....147	5268.....231	6325.....194	6496.....321	7035.....292
0161.....292	0436.....281	0975.....210	23860.....147	5290.....229	6331.....193	6497.....320	7100.....290
0162.....280	0442.....282	0976.....210	23870.....147	5291.....228	6334.....193	6498.....322	7101.....291
0164.....280	0445.....282	0978.....210	23890.....147	6000.....484	6335.....193	6540.....348	7102.....290
0169.....280	0447.....282	0983.....211	23900.....147	6001.....482	6337.....193	6541.....348	7103.....291
0179.....282	0448.....282	0984.....211	26010.....149	6002.....485	6338.....193	6542.....348	7106.....291
0181.....279 - 280	0456.....277	0985.....211	26020.....149	6003.....486	6340.....193	6550.....319	7160.....293
0183.....289	0466.....287	0986.....211	26030.....149	6004.....487	6343.....193	6602.....284	7162.....293

# INDEX DES RÉFÉRENCES MOB



7164.....293	9012.....115	9100041001.....129	9106.....130	9212100501.....94	9213230501.....95	9263201001.....91	929E080201.....82
7165.....293	9013.....106	9100050001.....129	9111.....129	9212101001.....79	9213240001.....90	9263250501.....95	929E080401.....69
7166.....293	9015.....102	9100051001.....129	9112.....129	9212110001.....79	9213240501.....95	9263400001.....91	929E090201.....82
7170.....290	9016.....103	9100060001.....129	9113.....130	9212110501.....94	9213241001.....90	9263401001.....91	929E100201.....82
7171.....291	9017.....319	9100070001.....129	9120.....130	9212111001.....79	9213270001.....90	9264.....93	929E120201.....82
7172.....292	9018.....319	9100080001.....129	9121.....130	9212120001.....79	9213270501.....95	9265.....67	929E140201.....82
7173.....292	9019.....119	9100090001.....129	9122.....131	9212120101.....80	9213271001.....90	9267.....82	929E170201.....82
7175.....292	9020.....115	9100091001.....129	9123.....131	9212120501.....94	9213280001.....90	9270.....69	929E190201.....82
7181.....296	9021.....319	9100100001.....129	9128005001.....131	9212121001.....79	9213280501.....95	9271.....77	929E.....69
7184.....296	9022.....119	9100101001.....129	9128005101.....131	9212121001.....79	9213290001.....90	9272.....82	9300170001.....163
7185.....297	9023.....319	9100110001.....129	9128010001.....133	9212130001.....79	9213290501.....95	9273.....91	9300170401.....160
7187.....295	9024.....319	9100120001.....129	9129000301.....132	9212131001.....79	9213300001.....90	9274.....93	9300171001.....163
7188.....299	9025.....319	9100130001.....129	9129000401.....131	9212140001.....79	9213300501.....95	9278121001.....80	9300171401.....160
7191.....297	9026.....319	9100510001.....135	9129000501.....132	9212140101.....80	9213301001.....90	9278141001.....68	9300660401.....163
7192.....297	9027001201.....322	9100520001.....135	9129000601.....132	9212140501.....94	9213320001.....90	9281.....90	9301.....160
7210.....286	9027010001.....322	9100530001.....135	9129000701.....132	9212141001.....79	9213320501.....95	9282.....80	9302.....160
7211.....287	9027720001.....78	9100531001.....135	9129000801.....132	9212150001.....79	9213321001.....90	9283150001.....151	9303.....161
7212.....287	9028.....86	9100550001.....135	9129001101.....131	9212150501.....94	9213330001.....90	9283160001.....69	9304.....160
7213.....287	9030.....119	9100551001.....135	9129001201.....132	9212151001.....79	9213330501.....95	9283200101.....151	9305.....159
7214.....287	9031.....119	9100580001.....135	9129001901.....132	9212160001.....79	9213340501.....95	9283201101.....151	9306.....175 - 176
7220.....287	9043.....118	9100581001.....135	9129100101.....132	9212160101.....80	9213350501.....95	9284.....69	9311.....161
7230.....297	9044.....117	9100600001.....135	9129500101.....136	9212160501.....94	9213360001.....90	9285.....77	9312.....160
7240.....286	9045.....117	9100630001.....136	9129500201.....136	9212161001.....79	9213360501.....95	9286.....82	9320.....172
7241.....287	9046.....117	9100631001.....136	9129500301.....136	9212170001.....79	9213361001.....90	9290.....67	9321.....172
7245.....292	9047.....117	9101010001.....129	9130.....134	9212170501.....94	9213380001.....90	9291.....77	9322.....172
7248.....288	9049.....117	9101010301.....134	9132.....134	9212171001.....79	9213380501.....95	9292340501.....94	9323.....173
7250.....287	9050.....125	9101011001.....129	9135.....152	9212180001.....79	9213410001.....90	9292380001.....82	9330.....183
7251.....287	9051.....139 - 140	9101020001.....129	9150.....133	9212180101.....80	9213410501.....95	9293100001.....91	9331.....183
7252.....287	9052.....139-140	9101020301.....134	9152.....133	9212180501.....94	9213411001.....90	9293100501.....95	9340.....167
7253.....287	9053.....139	9101030001.....129	9153.....133	9212181001.....79	9213420501.....95	9293120001.....91	9341.....167
7254.....287	9055.....123	9101030301.....134	9154.....133	9212190001.....79	9213460001.....90	9293120501.....95	9342.....167
7255.....230	9058.....124	9101040001.....129	9157.....133	9212190501.....94	9213460501.....95	9293121001.....91	9343.....167
7256.....230	9061009001.....141	9101040301.....134	9160.....137	9212191001.....79	9213461001.....90	9294340001.....93	9350.....182
7257.....230	9061010101.....141	9101041001.....129	9162.....137	9212200001.....79	9213500001.....90	9294340501.....95	9360.....163
7258.....288	9061011101.....141	9101050301.....134	9164.....137	9212200101.....80	9213501001.....90	9295.....110	9361.....166
7259.....288	9061020101.....138	9101051001.....129	9165.....137	9212201001.....79	9213550001.....90	9297.....110	9362.....160
7260.....289	9062006001.....141	9101060301.....134	9169.....137	9212210001.....79	9214.....93	9298.....110	9365.....166
7261.....288 - 289	9062006101.....141	9101070001.....129	9180.....143	9212210101.....80	9215.....80	9299.....95	9366.....166
7262.....288	9062008001.....141	9101080001.....129	9190.....338	9212210501.....94	9216.....66	929A000101.....69	9367.....161
7263.....288	9062010101.....141	9101090001.....129	919A.....150	9212211001.....79	9217.....76	929A000201.....77	9368.....160
7266.....288 - 289	9062010901.....141	9101100001.....129	919B.....150	9212220001.....79	9218.....90	929A001101.....69	9369.....167
7267.....231	9062011101.....141	9101110001.....129	919C.....150	9212220101.....80	9219.....93	929A060401.....69	9371.....184
7268.....231	9062011201.....141	9102010001.....129	919D.....150	9212220501.....94	9220.....67	929A160201.....82	9400.....89
7303.....285	9062012101.....141	9102011001.....129	919E.....150	9212221001.....79	9222.....94	929A200201.....82	9410043001.....89
7311.....285	9062021001.....140	9102020001.....129	919F.....151	9212230001.....79	9223.....95	929A260201.....82	9410310101.....74
7312.....285	9062031001.....140	9102021001.....129	9196.....150	9212231001.....79	9226.....77	929B010401.....69	9410390001.....71
7313.....285	9062041001.....140	9102030001.....129	919I.....151	9212240001.....79	9227.....80	929B020401.....69	9411.....74
7337.....222	9062051001.....140	9102031001.....129	919J.....151	9212240101.....80	9230.....88	929B030401.....69	9413.....86
7353.....222	9062061001.....140	9102040001.....129	919K.....151	9212240501.....94	9231.....88	929C010401.....69	9415.....74
8001.....253	9062071001.....140	9102510001.....135	919Z.....151	9212241001.....79	9232.....88	929C020401.....69	9416000101.....46
8004.....250	9062091001.....140	9102520001.....135	9200100001.....65	9212250001.....79	9233.....88	929C030401.....69	9416009001.....337
8005.....251	9062101001.....140	9102521001.....135	92005600SB.....184	9212260001.....79	9250.....67	929D100401.....69	9416033001.....155
8007.....251	9062A21001.....140	9102530001.....135	9200720001.....64	9212260101.....80	9251.....77	929D150401.....69	9416042001.....124
8008.....251	9064010101.....141	9102531001.....135	9200720101.....64	9212261001.....79	9252000001.....82	929D200401.....69	9416046001.....73
8009.....251	9064011101.....141	9103010001.....130	9200721001.....64	9212270001.....79	9252000501.....94	929D250401.....69	9416046101.....75
8013.....251	9064011201.....141	9103010301.....134	9200721101.....64	9212270501.....94	9252001001.....82	929D270201.....82	9416107001.....155
8014.....252	9064020101.....138	9103011001.....130	9201.....76	9212271001.....79	9253000001.....91	929D270401.....69	9420010001.....77
8015.....252	9065.....140	9103020001.....130	9202.....78	9212280001.....79	9253000501.....95	929D300201.....82	9420017001.....89
8017.....252	9066.....141	9103020301.....134	9203.....90	9212280101.....80	9253001001.....91	929D300401.....69	9420020001.....77
8018.....252	9067.....142	9103021001.....130	9204.....92	9212280501.....94	9254.....93	929D400201.....82	9426.....72
8020.....184	9068.....142 - 143	9103030001.....130	9205.....65	9212290001.....79	9260.....68	929D400401.....69	9430030501.....95
9000.....99 - 100	9069.....142	9103030301.....134	9210.....66	9212300001.....79	9261.....77	929D450201.....82	9430070001.....80
9000000001.....30	9071.....141	9103031001.....130	9211.....76	9212300101.....80	9262070001.....82	929D500201.....82	9430270101.....83
9001.....99	9073.....142	9103040001.....130	9212010501.....95	9212300501.....94	9262070501.....94	929D550201.....82	9431.....83
9002.....105	9074.....122	9103510001.....136	9212020201.....80	9212301001.....79	9262120001.....82	929D600201.....82	9435.....84
9003.....109	9078.....119	9103520001.....136	9212060201.....80	9212320001.....79	9262120501.....94	929E020401.....69	9436000001.....46
9004.....109	9079.....119	9103521001.....136	9212080001.....79	9212320101.....80	9262121001.....82	929E030401.....69	9436008001.....165
9005.....111 - 112	9100010001.....129	9103521101.....136	9212080201.....80	9212320501.....94	9262201501.....94	929E040401.....69	9436016001.....161
9006.....113	9100011001.....129	9103530001.....136	9212080501.....94	9212321001.....79	9262250001.....82	929E050201.....82	9436019001.....337
9007.....112	9100020001.....129	9103531001.....136	9212081001.....79	9213190501.....95	9262250501.....94	929E050401.....69	9436028001.....85
9008.....107	9100030001.....129	9103531101.....136	9212090001.....79	9213220001.....90	9262251001.....82	929E060201.....82	9436033001.....86
9010.....114	9100031001.....129	9104.....130	9212091001.....79	9213220501.....95	9263170501.....95	929E060401.....69	9436033101.....76
9011.....113	9100040001.....129	9105.....130	9212100001.....79	9213221001.....90	9263200001.....91	929E070201.....82	9436033201.....86



# INDEX DES RÉFÉRENCES MOB

9436044001..... 110	9499105001..... 51	9515109601..... 31	9523 ..... 24	9551 ..... 26	9574000001..... 40	9602 ..... 333	9806 ..... 28
9440 ..... 92	9499116001..... 50	9515141601..... 31	9530 ..... 58	9552 ..... 27	9574067001..... 57	9603 ..... 184	9807 ..... 29
9450 ..... 93	9499174001..... 53	9515156601..... 32	9534000001..... 43	9553 ..... 27	9575000001..... 40	9604010010..... 329	9808 ..... 29
9460000110..... 151	9500 ..... 36	9515173601..... 32	9534125001..... 58	9554000201..... 27	9576000001..... 38	9604020010..... 330	9809 ..... 29
9460000210..... 151	9501000001..... 35	9516000501..... 22	9534128001..... 59	9554000301..... 29	9576040001..... 57	9604030010..... 330	9810 ..... 29
9460012001..... 134	9501000101..... 35	9516000601..... 22	9535000001..... 43	9555 ..... 36	9577 ..... 56	9604030LED..... 330	9811 ..... 27
9460030010..... 154	9501000110..... 36	9516000701..... 22	9535128001..... 60	9556 ..... 36	9578 ..... 37	9604031201..... 330	9812 ..... 29
9460031001..... 70	9501040101..... 54	9516001701..... 22	9538000001..... 43	9557 ..... 36	9580000001..... 41	9604050001..... 330	9813 ..... 29
9460033001..... 153	9501050101..... 54	9516126601..... 32	9538128001..... 60	9558 ..... 27	9580016001..... 55	9604060001..... 332	9814 ..... 29
9460035001..... 154	9501060001..... 112	9516141501..... 31	953812800A..... 61	9561 ..... 25	9586 ..... 133	9604070001..... 331	9819 ..... 27
9460048001..... 153	9501070101..... 54	9516156601..... 32	9540 ..... 27	9562 ..... 25	9587 ..... 41	9605 ..... 30	9820 ..... 143
9461 ..... 155	9501093001..... 55	9516173601..... 32	9541 ..... 25	9564 ..... 25	9588 ..... 41	9606 ..... 143	9821 ..... 143
9462 ..... 152	9502 ..... 55	9516173701..... 32	9542 ..... 25	9565 ..... 25	9589 ..... 34	9610 ..... 323	9822 ..... 29
9470 ..... 89	9504 ..... 36	9517 ..... 19	9543 ..... 26	9566000001..... 25	9591000001..... 39	9772 ..... 38	
9476 ..... 47	9505 ..... 36	9518000701..... 20	9544 ..... 25	9566003001..... 117	9591053001..... 57	9800 ..... 27	
9477 ..... 48 - 49	9506000101..... 36	9518173701..... 32	9545 ..... 25	9566003101..... 117	9591080001..... 57	9801 ..... 27	
9480 ..... 100	9506025301..... 55	9519000601..... 19	9547 ..... 25	9566004001..... 25	9592000001..... 39	9802 ..... 28	
9481 ..... 66 - 67	9513 ..... 30	9519126601..... 32	9548 ..... 25	9570000001..... 37	9592025001..... 56	9803 ..... 28	
9482 ..... 79	9515000601..... 23	9522000601..... 21	9549 ..... 26	9570024001..... 56	9600 ..... 333	9804 ..... 28	
9499068001..... 52	9515057601..... 30	9522173601..... 32	9550 ..... 26 - 27	9570047001..... 56	9601 ..... 333	9805 ..... 28	



# INDEX DES RÉFÉRENCES MONDELIN

101000..... 433	103098..... 197	151060..... 454	153700..... 448	161300..... 459	171111..... 458	171352..... 458	212260..... 431
101010..... 433	103100..... 449	151080..... 454	153710..... 376	161400..... 459	171112..... 458	171360..... 457	212270..... 431
101020..... 434	103168..... 197	151120..... 454	153720..... 506	161410..... 459	171120..... 457	171361..... 458	212960..... 431
101030..... 434	103188..... 197	151310..... 454	153730..... 506	161420..... 459	171121..... 458	171362..... 458	212970..... 431
101100..... 472	103198..... 197	151320..... 454	153740..... 506	163360..... 449	171122..... 458	171370..... 457	213360..... 431
101110..... 472	103308..... 196	151330..... 454	154080..... 450	164340..... 449	171130..... 457	171371..... 458	214600..... 431
101120..... 472	103318..... 196	151340..... 454	154090..... 450	164350..... 449	171131..... 458	171372..... 458	214700..... 431
101300..... 434	103328..... 196	151350..... 454	154130..... 450	164380..... 449	171132..... 458	171380..... 457	215600..... 431
101310..... 434	103498..... 196	151430..... 454	154140..... 450	164390..... 449	171140..... 457	171381..... 458	215650..... 431
101338..... 434	103518..... 196	151440..... 454	154150..... 450	171010..... 457	171141..... 458	171382..... 458	220040..... 479
101400..... 434	103528..... 196	152000..... 454	155500..... 444	171011..... 458	171142..... 458	201170..... 425	220050..... 479
101450..... 441	103538..... 196	152500..... 472	155510..... 444	171012..... 458	171150..... 457	201180..... 425	220060..... 479
101500..... 435	103548..... 196	152510..... 472	155520..... 445	171020..... 457	171151..... 458	201200..... 424	220070..... 479
101510..... 435	103558..... 196	152520..... 473	155530..... 445	171021..... 458	171152..... 458	201250..... 425	220080..... 479
101520..... 435	103578..... 196	152530..... 473	155540..... 446	171022..... 458	171160..... 457	201300..... 426	220100..... 479
101550..... 435	103588..... 196	152540..... 473	155550..... 446	171030..... 457	171161..... 458	201590..... 432	220140..... 479
101690..... 435	113000..... 314	152550..... 473	155560..... 444	171031..... 458	171162..... 458	201600..... 432	220150..... 479
101700..... 435	113010..... 315	152560..... 472	155570..... 446	171032..... 458	171170..... 457	201610..... 432	220160..... 479
101710..... 435	113020..... 315	152570..... 473	155808..... 447	171040..... 457	171171..... 458	201620..... 432	220170..... 479
101720..... 435	113050..... 314	152590..... 473	155828..... 447	171041..... 458	171172..... 458	201630..... 432	220180..... 479
101770..... 441	113060..... 314	152600..... 473	155840..... 447	171042..... 458	171180..... 457	201700..... 308	220200..... 479
101780..... 441	114150..... 494	152610..... 473	155858..... 230	171050..... 457	171181..... 458	201740..... 309	220240..... 479
101790..... 441	114160..... 494	152710..... 472	155878..... 447	171051..... 458	171182..... 458	201760..... 309	220250..... 479
101800..... 441	114170..... 493	152720..... 473	155900..... 460	171052..... 458	171300..... 457	201770..... 309	220260..... 479
101810..... 420	114200..... 493	152730..... 473	155910..... 460	171060..... 457	171301..... 458	201800..... 309	220270..... 479
101830..... 441	114210..... 493	152740..... 473	155920..... 460	171061..... 458	171302..... 458	201830..... 311	221600..... 478
101841..... 507	116010..... 442	152750..... 473	155930..... 460	171062..... 458	171310..... 457	201900..... 307	221610..... 478
101851..... 507	120000..... 433	152760..... 474	156050..... 456	171070..... 457	171311..... 458	201910..... 307	221620..... 478
101861..... 507	151000..... 454	152820..... 474	156200..... 455	171071..... 458	171312..... 458	201920..... 307	221630..... 478
101871..... 507	151010..... 454	152830..... 474	156300..... 456	171072..... 458	171320..... 457	201930..... 307	221640..... 478
101881..... 507	151020..... 454	152840..... 474	156400..... 448	171080..... 457	171321..... 458	201950..... 305	221650..... 478
101891..... 507	151022..... 454	153000..... 448	156430..... 442	171081..... 458	171322..... 458	201955..... 305	221660..... 478
101931..... 507	151025..... 454	153020..... 448	161140..... 459	171082..... 458	171330..... 457	201960..... 305	221700..... 478
101941..... 507	151030..... 454	153080..... 454	161150..... 459	171090..... 457	171331..... 458	201970..... 305	221710..... 478
101951..... 507	151032..... 454	153090..... 454	161200..... 459	171091..... 458	171332..... 458	201980..... 305	221720..... 478
101960..... 507	151035..... 454	153100..... 454	161220..... 459	171092..... 458	171340..... 457	202070..... 430	221730..... 478
101970..... 507	151040..... 454	153550..... 447	161230..... 459	171100..... 457	171341..... 458	202500..... 431	221740..... 478
101980..... 507	151045..... 454	153570..... 460	161240..... 459	171101..... 458	171342..... 458	203120..... 425	221750..... 478
103038..... 197	151050..... 454	153580..... 460	161241..... 513	171102..... 458	171350..... 457	211960..... 431	221760..... 478
103088..... 197	151055..... 454	153690..... 449	161260..... 459	171110..... 457	171351..... 458	211970..... 431	221770..... 478



# INDEX DES RÉFÉRENCES MONDELIN



221780.....478	226780.....475	231901.....470	301770.....355	303250.....382	314102.....367	338623.....375	351025.....241
221790.....478	226800.....427	231911.....470	301780.....355	303251.....382	314112.....367	341000.....350	351030.....241
222100.....478	226806.....427	231921.....470	301790.....355	303260.....382	314122.....367	341010.....350	351040.....241
222120.....478	226810.....427	232004.....469	301800.....355	303261.....382	314157.....366	341020.....350	351050.....241
222140.....478	226816.....427	232014.....465	301810.....355	303270.....381	314167.....366	341030.....350	351060.....241
222160.....478	226820.....427	232021.....465	301840.....355	303280.....381	314177.....366	341031.....350	351200.....241
222180.....478	226826.....427	232031.....465	301860.....355	303290.....381	314187.....366	341032.....350	351250.....241
222200.....478	226910.....379	232221.....465	301880.....355	303300.....378	314220.....367	341040.....350	351300.....241
222220.....478	227400.....481	232231.....465	301900.....355	303310.....378	314357.....367	341060.....350	351400.....241
222240.....478	227500.....480	232401.....465	301920.....355	303320.....378	314367.....367	341070.....350	351500.....241
223100.....478	227501.....480	232421.....465	301940.....355	303340.....380	314377.....367	341080.....350	351600.....241
223120.....478	227510.....480	232431.....465	301960.....355	303350.....383	314387.....367	341081.....350	351615.....241
223140.....478	227511.....480	233104.....469	301980.....355	303351.....383	314567.....367	341100.....351	351620.....241
223160.....478	227520.....480	233111.....469	302040.....355	303360.....383	314587.....367	341120.....351	351625.....241
223180.....478	227521.....480	233204.....471	302060.....355	303361.....383	314600.....368	341130.....351	351630.....241
223200.....478	227530.....480	233214.....471	302080.....355	303370.....383	315157.....366	341140.....351	351701.....242
223220.....478	227531.....480	233221.....471	302100.....355	303380.....383	315167.....366	341141.....351	351702.....242
223240.....478	227540.....480	233231.....471	302120.....355	303450.....361	315177.....366	342100.....352	351703.....242
223290.....478	227541.....480	233241.....471	302140.....355	303451.....361	315187.....366	342130.....352	351704.....242
223300.....477	227600.....480	233251.....471	302200.....384	303460.....361	316000.....370	342250.....352	351705.....242
223320.....477	227601.....480	233314.....471	302210.....384	303461.....361	316010.....370	342350.....352	351706.....242
223340.....477	227610.....480	233324.....471	302220.....370	308110.....293	316030.....370	342440.....354	351720.....242
223360.....477	227611.....480	233334.....471	302230.....370	308120.....293	316042.....370	342450.....354	351725.....242
223380.....477	227620.....480	233344.....471	302400.....371	308130.....293	316100.....371	343100.....353	351730.....242
223400.....477	227630.....480	233404.....471	302402.....371	309500.....293	316120.....371	343200.....353	351740.....242
223420.....477	227640.....480	234031.....467	302410.....371	309510.....293	316200.....371	343300.....353	351750.....242
223440.....477	227700.....480	234221.....467	302420.....460	309580.....357	316210.....371	343400.....353	351760.....242
223490.....477	227701.....480	234521.....466	302430.....460	309590.....357	317000.....431	343440.....354	351988.....242
224200.....421	227710.....480	234531.....466	302460.....460	309600.....357	317020.....431	343450.....354	351994.....242
224250.....476	227711.....480	234541.....466	302470.....372	309610.....357	317030.....431	343510.....353	351995.....242
224300.....476	227720.....480	234551.....466	30247K.....372	309620.....357	317040.....431	343520.....353	353240.....426
224350.....476	227721.....480	234641.....467	302480.....372	309650.....359	317050.....371	343530.....353	353250.....426
224500.....475	227800.....480	234651.....467	302490.....372	309670.....359	317060.....431	344000.....356	353260.....426
224600.....475	227801.....480	234661.....467	302500.....372	309910.....360	317100.....371	344010.....356	353275.....426
224610.....476	227810.....480	234671.....467	302510.....372	311000.....364	321000.....369	344020.....356	353300.....426
224620.....475	227811.....480	234681.....467	30251K.....372	311010.....364	321010.....369	344030.....356	353350.....426
224630.....475	227820.....480	243030.....430	302520.....372	311020.....364	321020.....369	344040.....356	353400.....426
224640.....475	227821.....480	243110.....430	30252K.....372	311032.....364	321030.....369	344050.....356	353500.....426
224650.....475	227830.....480	243200.....430	302530.....372	311042.....364	321100.....369	344060.....356	353600.....426
224660.....475	227831.....480	243220.....430	30253V.....372	311052.....364	321101.....369	344100.....360	354125.....449
224670.....475	227840.....480	243230.....430	302540.....372	311100.....364	321110.....369	345020.....510	354150.....449
224830.....476	227841.....480	244560.....430	30254V.....372	311110.....364	321190.....369	345040.....510	354175.....449
224840.....476	227920.....480	244570.....430	302550.....372	311120.....364	321191.....369	345050.....510	354200.....449
224850.....476	227921.....480	244600.....430	30255K.....372	311132.....364	321200.....369	345070.....510	354250.....449
224870.....479	227930.....480	300920.....384	302560.....372	311170.....364	321201.....369	345090.....510	354300.....449
224880.....479	231004.....464	300940.....384	30256K.....372	311170.....364	321210.....369	345120.....510	354400.....449
224900.....433	231014.....464	300970.....384	302570.....372	311310.....363	321211.....369	345170.....514	354500.....449
224910.....479	231021.....464	301010.....384	30257K.....372	311320.....363	321220.....369	345180.....514	354600.....449
224920.....453	231031.....464	301020.....384	302580.....372	311332.....363	321230.....369	345190.....514	354712.....449
224921.....453	231214.....464	301030.....384	30258K.....372	311352.....363	321240.....369	348000.....515	354715.....449
224930.....453	231221.....464	301040.....384	302590.....372	311370.....363	321250.....369	348010.....515	354720.....449
224931.....453	231321.....421	301050.....384	30259K.....372	311370.....363	321260.....369	348020.....515	354725.....449
224940.....453	231331.....467	301070.....384	302600.....372	311320.....363	321270.....369	348030.....515	354730.....449
224941.....453	231421.....469	301080.....384	302610.....372	311332.....363	321300.....370	348060.....515	354740.....449
224950.....453	231521.....468	301090.....384	302620.....372	311352.....363	321310.....367	348070.....516	354750.....449
224951.....453	231531.....468	301100.....384	302630.....372	312042.....365	321320.....367	348090.....516	354760.....449
224960.....453	231541.....468	301150.....384	302640.....372	312052.....365	321330.....367	348100.....516	355200.....426
224961.....453	231551.....468	301160.....384	302650.....372	312100.....365	321360.....367	348110.....516	355250.....426
224990.....461	231561.....468	301180.....371	302660.....372	312110.....365	321390.....367	348200.....518	355300.....426
224991.....453	231601.....468	301181.....371	302670.....372	312120.....365	322000.....370	350010.....242	355400.....426
225000.....461	231611.....468	301210.....371	302680.....372	312132.....365	322010.....370	350011.....242	356620.....242
225001.....453	231621.....468	301220.....371	302690.....372	312170.....365	322020.....370	350020.....242	356625.....242
225100.....452	231631.....468	301230.....371	302900.....372	313000.....365	322100.....370	350021.....242	356630.....242
225201.....453	231641.....468	301240.....371	302910.....372	313010.....365	322110.....370	350030.....242	356640.....242
225350.....431	231701.....470	301260.....371	302920.....372	313020.....365	322120.....370	350040.....242	356650.....242
225500.....431	231711.....470	301310.....345	302930.....372	313032.....365	323000.....376	350041.....242	356660.....242
225600.....431	231741.....470	301350.....345	302940.....372	313042.....365	330206.....428	350052.....414	357100.....427
225800.....431	231761.....470	301410.....345	302950.....372	313052.....365	330226.....428	350140.....453	357125.....427
225870.....479	231771.....470	301450.....371	302960.....372	313100.....365	331206.....428	350230.....242	357150.....427
225880.....479	231811.....470	301510.....370	303000.....379	313110.....365	332166.....428	350240.....242	357200.....427
226350.....475	231831.....469	301520.....370	303040.....379	313120.....365	334160.....452	350250.....414	357250.....427
226500.....475	231841.....469	301610.....370	303050.....379	313132.....365	335200.....428	350262.....414	357300.....427
226600.....475	231861.....469	301620.....370	303100.....358	313170.....365	338513.....375	350270.....242	357610.....427
226730.....475	231871.....469	301740.....355	303110.....358	314020.....367	338523.....375	350280.....242	357612.....427
226750.....475	231881.....469	301750.....355	303240.....382	314050.....367	338563.....375	350290.....242	357615.....427
226760.....475	231891.....469	301760.....355	303241.....382	314060.....367	338573.....375	351020.....241	357617.....427



# INDEX DES RÉFÉRENCES MONDELIN

357620.....427	502558.....417	801305.....500	811112.....243	815140.....247	852550.....434	862640.....437	872810.....239
357625.....427	502560.....417	801310.....501	811118.....243	815160.....247	852560.....434	862650.....437	872820.....241
357690.....427	502600.....416	801311.....501	811120.....243	815170.....247	853020.....505	862740.....437	872850.....239
358100.....427	502638.....416	801320.....500	811128.....243	815180.....247	853060.....505	862780.....433	872890.....239
358125.....427	502650.....416	801520.....504	811150.....243	815190.....247	853090.....505	862800.....433	872900.....239
358150.....427	502660.....415	801540.....504	811160.....243	815208.....247	853120.....505	862820.....433	873020.....237
358175.....427	502700.....422	801600.....517	811168.....243	821420.....247	853180.....505	862900.....437	873120.....237
358200.....427	502710.....422	801620.....246	812100.....388	821510.....247	853200.....505	862910.....437	873128.....237
358250.....427	502720.....422	801630.....504	812118.....388	821520.....247	854050.....505	862920.....437	873220.....237
358300.....427	502730.....422	801640.....504	812120.....388	821530.....247	860610.....438	863000.....512	873228.....237
358602.....242	502740.....422	801700.....503	812138.....388	821550.....247	860620.....438	863020.....512	873530.....236
358610.....427	503018.....410	801710.....503	812140.....388	822010.....247	860630.....438	863030.....512	873538.....236
358612.....427	503108.....410	801720.....503	812158.....388	822030.....247	860640.....438	863040.....512	873550.....236
358615.....427	503111.....410	801740.....503	812160.....388	822050.....247	860650.....438	863050.....512	873558.....236
358620.....427	503208.....411	801750.....503	813150.....243	823010.....247	860660.....438	863070.....512	873580.....236
358625.....427	503258.....447	801760.....503	813160.....243	823020.....247	860670.....438	863080.....512	873588.....236
358710.....427	503300.....410	801800.....503	813170.....243	823050.....247	860700.....439	863090.....512	873658.....237
358712.....427	503308.....410	801810.....502	813180.....243	823110.....247	860720.....439	863100.....511	873688.....237
358715.....427	503310.....410	801820.....502	813190.....243	823120.....247	860730.....439	863110.....511	874448.....236
358720.....427	503318.....410	801840.....503	813330.....243	823220.....246	860740.....439	863120.....511	874458.....236
358725.....427	503328.....377	801862.....502	813338.....243	823250.....246	860750.....439	863130.....511	874488.....236
361010.....362	503338.....411	801863.....502	813360.....243	823259.....246	860810.....438	863140.....514	874498.....236
361020.....362	503348.....411	801865.....502	813368.....243	823310.....246	860820.....438	863160.....513	875230.....237
361030.....362	503368.....411	801870.....502	813390.....243	823320.....246	860830.....438	863170.....514	875250.....237
361110.....362	503378.....410	801881.....502	813398.....243	823400.....247	860850.....438	863180.....511	875310.....236
361200.....362	503380.....412	801882.....502	813430.....243	824000.....247	861010.....438	863190.....511	875320.....236
362200.....362	504800.....403	801890.....502	813460.....243	824010.....247	861020.....438	863200.....511	876210.....237
362300.....362	504810.....403	801891.....502	813490.....243	824100.....247	861030.....438	863210.....511	876230.....237
401000.....386	504990.....419	801900.....503	814180.....244	824140.....247	861040.....438	863220.....511	876310.....237
401100.....386	505000.....419	801910.....503	814190.....244	824200.....247	861070.....438	863230.....511	876500.....237
401500.....387	505010.....419	801920.....503	814200.....244	824210.....247	861100.....439	863240.....511	877038.....236
401600.....388	505020.....419	801940.....503	814350.....244	824260.....498	861120.....439	863250.....511	877058.....236
403000.....387	505110.....422	801970.....519	814360.....244	825000.....497	861130.....439	863260.....511	877108.....236
403011.....388	513000.....395	801980.....518	814370.....244	825010.....497	861140.....439	863270.....511	877138.....236
403500.....387	513200.....403	801990.....518	814380.....244	825020.....497	861150.....439	863280.....514	877158.....236
500510.....313	513300.....402	802000.....518	814390.....244	825118.....497	861210.....438	863290.....433	877159.....236
500512.....313	514000.....397	802010.....518	814410.....244	830520.....435	861220.....438	863300.....514	877188.....236
500513.....313	516000.....399	802020.....519	814420.....244	830530.....435	861230.....438	863310.....511	877258.....236
500520.....414	516500.....401	802030.....518	814430.....244	830580.....413	861240.....438	863320.....511	877288.....236
500530.....313	517000.....401	802050.....519	814440.....244	830581.....413	861250.....438	863330.....514	877308.....237
500540.....404	801000.....517	802070.....518	814500.....244	830582.....413	861300.....441	863350.....511	877508.....237
500550.....404	801010.....517	802080.....519	814510.....244	830583.....413	861310.....441	863400.....513	878000.....238
500560.....405	801040.....517	802090.....519	814902.....246	830584.....413	861320.....441	863410.....513	881000.....434
500570.....405	801050.....517	802120.....519	814904.....246	830585.....413	861350.....441	864000.....504	881010.....509
500610.....312	801060.....517	802150.....518	814905.....246	830586.....413	861360.....441	864010.....504	881020.....509
501050.....408	801070.....517	802170.....519	814906.....246	830589.....377	862010.....507	864100.....504	881030.....509
501100.....409	801080.....517	802180.....519	814907.....246	830700.....194	862100.....436	864110.....504	881040.....509
501200.....408	801100.....517	802190.....519	814918.....245	831580.....193	862110.....436	864120.....504	881050.....509
501250.....408	801110.....517	802210.....518	814920.....245	831600.....193	862120.....436	865100.....504	881060.....509
501300.....408	801200.....500	802220.....518	814928.....245	832820.....195	862130.....436	865130.....504	881070.....434
501350.....408	801201.....500	802230.....519	814930.....245	832821.....195	862200.....436	865140.....504	881300.....508
501400.....408	801210.....501	802240.....518	814938.....245	832900.....194	862210.....436	865200.....504	881310.....508
501550.....408	801211.....501	802250.....519	814940.....245	832908.....194	862220.....436	870400.....239	881311.....508
501600.....409	801220.....501	802260.....519	814950.....245	832928.....193	862230.....436	870500.....239	881312.....508
501700.....409	801221.....501	802350.....519	814958.....245	832930.....195	862260.....436	870600.....239	881313.....508
501710.....409	801230.....501	802550.....516	814960.....245	832931.....195	862270.....436	870800.....239	881315.....508
501720.....409	801231.....501	802560.....516	814968.....245	832940.....195	862280.....436	871000.....239	881317.....508
502000.....418	801240.....501	802570.....516	814970.....245	833150.....447	862300.....436	871200.....239	881319.....508
502010.....418	801241.....501	802580.....516	814978.....245	833168.....447	862310.....436	871500.....239	970130.....437
502050.....418	801250.....501	802600.....516	814980.....246	833320.....447	862320.....436	872000.....239	970131.....441
502100.....406	801251.....501	802610.....516	814981.....246	833330.....447	862330.....436	872040.....239	PR0012.....395
502110.....406	801270.....501	802620.....516	814991.....246	833350.....447	862350.....435	872050.....239	PR0199.....401
502120.....406	801271.....501	802630.....516	814997.....246	833360.....447	862390.....437	872060.....239	PR0211.....399
502150.....421	801272.....501	805000.....42	815000.....245	833370.....447	862420.....437	872080.....239	PR0296.....401
502160.....415	801280.....501	805010.....42	815002.....245	833400.....447	862430.....437	872100.....239	PR0298.....395
502170.....407	801281.....501	805020.....42	815010.....245	833410.....447	862440.....437	872120.....239	
502180.....419	801290.....377	805030.....42	815017.....245	841220.....510	862450.....437	872140.....239	
502200.....412	801291.....377	805080.....42	815018.....245	841240.....510	862460.....437	872160.....239	
502500.....417	801292.....377	805100.....41	815020.....246	841250.....510	862470.....437	872170.....239	
502508.....417	801293.....377	805150.....41	815030.....245	841260.....510	862540.....437	872180.....239	
502510.....417	801294.....377	805200.....42	815038.....245	841280.....510	862550.....437	872190.....239	
502528.....417	801300.....500	805210.....42	815040.....247	843200.....510	862560.....437	872400.....239	
502530.....417	801301.....500	811001.....243	815060.....247	844240.....510	862570.....437	872500.....239	
502540.....417	801302.....500	811012.....243	815080.....247	852500.....434	862600.....437	872600.....239	
502548.....417	801303.....500	811018.....243	815100.....247	852520.....434	862610.....437	872800.....239	
502550.....417	801304.....500	811101.....243	815120.....247	852530.....434	862620.....437	872805.....239	



# CONDITIONS GÉNÉRALES DE VENTE



## 1 – VALIDITÉ ET COMMANDES

Nos Conditions Générales de Vente sont seules valables, même en cas d'indications contraires figurant dans les conditions d'achat de nos clients. Le seul fait de nous passer commande comporte l'acceptation sans réserve de chacune d'entre elles y compris la clause dite de réserve de propriété. Les engagements pris par nos représentants ne sont valables qu'après acceptation officielle par notre société. Pour tous les produits livrés sur stock nous n'accusons pas réception des commandes. Les délais sont donnés à titre indicatif.

## 2 – PRIX

Nos prix sont établis conformément à la législation en vigueur. Ils sont fixés en euros hors taxes et ne constituent en aucun cas des prix de vente aux consommateurs. Ils servent de base aux calculs des remises et bonifications éventuelles. En raison des variations du coût des matières premières ou de la main d'oeuvre, nos prix sont remis à titre indicatif sans engagement de durée et nos marchandises sont facturées au tarif en vigueur au jour de la livraison, sans avis préalable. Les produits sont normalement vendus selon l'unité de conditionnement indiqué au tarif ou un multiple de celle-ci. Toute vente en dessous de l'unité de conditionnement entraîne une hausse de 8 % (à l'exception de certains produits non déconditionnables).

## 3 – PORT, MINIMUM DE COMMANDE, CONDITIONS DE LIVRAISON ET CONTESTATIONS POSTÉRIEURES À LA LIVRAISON

Pour toute commande inférieure à 100 euros, une charge forfaitaire de 30 euros sera facturée en sus de la marchandise. Le franco de port et d'emballage est accordé pour le territoire métropolitain, y compris la Corse, pour toute facture d'un montant minimum net de 500 euro HT. Pour les DOMTOM et l'étranger ce franco s'applique jusqu'à la frontière ou jusqu'au port d'embarquement s'il est situé en France. En cas de livraison incomplète et sauf avis contraire des clients, les soldes seront repris automatiquement lorsque le montant des produits non-livrés sera supérieur à 50 €, seuil en dessous duquel les commandes seront soldées. Les contestations relatives aux livraisons doivent nous parvenir dans les huit jours de la réception de la facture correspondante par voie écrite. Au-delà de ce délai, aucune contestation sur les quantités livrées ne sera plus admise. Si le litige concerne le transporteur (colis endommagé), il doit lui être signalé par réserves portées sur le bordereau de transport, confirmées par lettre recommandée avec avis de réception, adressée à son attention, dans les 48 heures de la réception de la marchandise litigieuse. Une copie de ces documents doit nous être adressée. Nous ne sommes pas responsables des délais d'acheminement. En cas d'envois express ou de transporteur imposés par le client les frais de port seront à la charge du destinataire.

## 4 – CONDITIONS DE PAIEMENT

Nos factures sont payables au comptant à notre siège social à l'enlèvement des marchandises. Pour les clients ayant un compte ouvert dans nos livres le règlement s'effectue à fin de mois plus 45 jours, net et sans escompte sauf mention contraire sur la facture et sous réserve d'un paiement. Tout retard de paiement par rapport aux conditions convenues entraînera, outre l'application de l'indemnité forfaitaire pour frais de recouvrement d'un montant de 40 € (décret n°2012-1115 du 2/10/12), l'application d'un intérêt de retard égal au taux de l'intérêt légal majoré en vigueur le jour de l'échéance. Il entraînera en outre de plein droit la déchéance du terme et l'exigibilité immédiate de toutes les sommes dues. Dans ce cas, nous pourrions suspendre la livraison de toutes les commandes en carnet et appliquer à titre de clause pénale une indemnité de 15% sur les sommes restant dues.

## 5 – CLAUSE DE RÉSERVE DE PROPRIÉTÉ

Les outils et pièces que nous livrons restent notre propriété jusqu'au complet paiement intégral de leur prix. Cependant la responsabilité de ces outils et pièces est transférée à l'acheteur dès leur expédition. Toute revente avant complet paiement du prix sera réputée effectuée pour notre compte et les créances nées de cette revente nous appartiendront dans la limite des sommes restant dues, majorées des intérêts de retard correspondants. En cas de non paiement partiel ou total du prix à l'une quelconque des échéances convenues, nous pourrions, sans aucune formalité, exiger la restitution de tous les outils et pièces dans la limite des sommes qui nous sont dues. Les dispositions de la Loi n° 80335 du 12 mai 1980 s'appliqueront de plein droit. À ce titre les produits physiquement présents dans le stock seront réputés être les derniers acquis.

## 6 – RETOURS DE MARCHANDISES

Aucun retour de marchandise ne pourra être fait sans accord préalable de notre part. Les produits devront être restitués en parfait état, dans leur emballage et conditionnement d'origine, le port étant payé par l'expéditeur. L'avis sera établi sur la base du tarif en vigueur à l'époque de la vente initiale.

Par rapport à ces conditions un abattement de 20% sera appliqué pour tenir compte des frais de reconditionnement et de remise en stock. Pour tout produit endommagé et nécessitant une intervention de remise en état, le taux d'abattement sera augmenté pour couvrir le coût de réparation. Les modèles dont la commercialisation a cessé ne seront pas repris.

## 7 – GARANTIE FABRICANT

Nous apportons le plus grand soin à la réalisation de nos articles qui sont garantis contre tous vices de fabrication dans le cadre défini par la Loi et les règlements. Cette garantie cessera de jouer si le matériel est utilisé ou entretenu de façon anormale. Cette garantie se limite au remplacement des outils reconnus défectueux, à l'exclusion de tous dommages-intérêts pour quelque cause que ce soit. L'usage normal correspondant à un usage courant est exclusive de toute garantie. La référence aux normes en vigueur à la date d'impression du présent document ne constitue pas un engagement contractuel.

Des fiches techniques seront mises à disposition des clients pour les appareils de serrage contrôlé.

Les conseils d'usage et de sécurité ne se substituent pas aux règles professionnelles et nationales établies.

## 8 – FABRICATIONS SPÉCIALES

Les fabrications spéciales de produits hors catalogue ne sont enregistrées comme commandes fermes qu'après acceptation par notre client de notre offre technique ainsi que de nos prix et délais. Ces fabrications ne seront ni reprises ni échangées sauf mise en jeu de la garantie fabricant. Le client accepte que la quantité livrée varie de plus ou moins 10% par rapport à la quantité commandée.

## 9 – DOCUMENTATIONS, CARACTÉRISTIQUES TECHNIQUES DES PRODUITS ET ÉVOLUTION DE L'OFFRE

Les informations techniques (dimension, poids, taille...) et les documents photographiques figurant dans nos catalogues, tarifs et documentations diverses n'ont pas de caractère contractuel. Dans le cadre de l'amélioration de nos gammes ou pour toute autre raison, tous nos produits y figurant peuvent être modifiés ou supprimés sans préavis et sans obligation de modifier les articles déjà vendus. Nos documentations constituent notre propriété intellectuelle; elles ne peuvent pas être reproduites ou utilisées sans notre autorisation.

## 10 – PROPRIÉTÉ DES MARQUES

Les marques Mob, Mondelin, Levpano, Ergolame, Prochok, Talabot, Mekanix, Nertech, Carbon, Durlach, Cassi, Dynachoc, Schröder sont des marques déposées par le groupe MOB. La marque Phillips a été déposée par la société Phillips Screw Co. Pozidriv est une marque déposée par European Industrial Services, Torx est la marque déposée de Camcar/Textron. Circlips est la marque déposée de Nomel.

## 11 – DÉLAIS

Nos délais de livraison sont donnés à titre indicatif et ne peuvent constituer une obligation de notre part de livrer à une date spécifiée. Ils s'entendent sauf empêchement consécutif à un cas de force majeure. Les retards éventuels ne peuvent en aucun cas donner lieu à dommages-intérêts de notre part.

## 12 – CLAUSE ATTRIBUTIVE DE JURIDICTION ET DROIT APPLICABLE

De convention expresse toute contestation éventuelle devra être portée devant le Tribunal de Commerce de Saint-Étienne. Ce contrat est régi par le droit français. Cette clause attributive de juridiction est également applicable en cas d'appel en garantie ou de pluralité de défendeurs.



**MOB MONDELIN S.A.S**  
2, rue Bergognon - BP 69  
42502 LE CHAMBON-FEUGEROLLES  
Tél. : +33(0) 4 77 40 49 49  
Fax : +33(0) 4 77 61 80 74  
[www.mob-mondelin.fr](http://www.mob-mondelin.fr)

Catalogue K18

Réf. : 0000043301



Document non contractuel

FABRICANTS FRANÇAIS